



Split Type Air Conditioner

User Manual



BEEPI 090/ BEEPI 091
BEEPI 120/ BEEPI 121
BEHPI 090/ BEHPI 091
BEHPI 120/ BEHPI 121
BEHPI 180/ BEHPI 181

BEHPI 240/ BEHPI 241
BEVPI 090/ BEVPI 091
BEVPI 120/ BEVPI 121
BEVPI 180/ BEVPI 181
BEVPI 240/ BEVPI 241

EN | HR



10M-8899243200-5022-02

CONTENTS

ENGLISH 3-58

HRVATSKI 59-117

Please read this user manual first!

Dear Customer,

Thank you for preferring a Beko product. We hope that you get the best results from your product which has been manufactured with high quality and state-of-the-art technology. Therefore, please read this entire user manual and all other accompanying documents carefully before using the product and keep it as a reference for future use. If you handover the product to someone else, give the user manual as well. Follow all warnings and information in the user manual.

Meanings of the symbols

Following symbols are used in the various section of this manual:

	Important information or useful hints about usage.
--	--

	Warning for hazardous situations with regard to life and property.
--	--

	Warning to actions that must never perform.
--	---

	Warning for electric shock.
--	-----------------------------

	This symbol shows that information is available such as the operating manual or installation manual.
---	--

	Do not cover it.
--	------------------

	This symbol shows that the operation manual should be read carefully.
---	---

	This symbol shows that a service personnel should be handling this equipment with reference to the installation manual.
---	---

 (For R32/R290 gas type)	This symbol shows that this appliance used a flammable refrigerant. If the refrigerant is leaked and exposed to an external ignition source, there is a risk of fire.
--	---

CONTENTS

1 Safety Precautions	5	8 Test run	42
2 Overview	12	8.1 Test run instructions	42
2.1 Unit parts	13	9 Care and maintenance	43
2.2 Controls and parts.....	14	9.1 Cleaning your indoor unit.....	43
3 Unit specifications and features	15	9.2 Cleaning your air filter	43
3.1 Indoor unit display.....	15	9.3 Maintenance – long periods of non-use.....	45
3.2 Operating temperature	16	9.4 Maintenance – Pre-Season Inspection	45
3.3 Inverter Split type	17	10 Troubleshooting	46
3.4 Fixed-speed type	17	10.1 Common issues	46
3.5 Other features	18	10.2 Troubleshooting	48
3.6 Setting angle of air flow.....	19	11 European disposal guideline	51
3.6.1 Setting vertical angle of air flow	19	12 Installation instructions	52
3.6.2 Setting horizontal angle of air flow.....	19	12.1 F-Gas instruction	52
3.7 Install the HomeWhiz kit (wireless module).....	19	13 Specifications	53
3.8 Manual operation (without remote)	19		
4 Installation	21		
4.1 Installation summary - indoor unit.....	21		
4.2 Installation Instructions – Indoor unit	22		
4.2.1 Prior to installation	22		
4.2.2 Mounting plate dimensions.....	23		
4.2.3 Before performing any electrical work, read these regulations	25		
4.3 Outdoor Unit Installation	29		
4.3.1 Installation Instructions – Outdoor unit.....	29		
5 Refrigerant piping connection	35		
5.1 Connection Instructions – Refrigerant Piping.....	36		
5.2 Instructions for connecting piping to indoor unit	37		
5.3 Instructions for connecting piping to outdoor unit	38		
6 Air evacuation	39		
6.1 Preparations and precautions	39		
6.1.1 Before performing evacuation	39		
6.1.2 Evacuation instructions.....	39		
6.1.3 Note on adding refrigerant.....	40		
7 Electrical and gas leak checks	41		
7.1 Before test run.....	41		
7.2 Electrical safety checks	41		
7.3 Gas leak checks.....	41		

1 Safety Precautions

Warning

This appliance can be used by children aged from 8 years and above and persons with reduced physical, sensory or mental capabilities or lack of experience and knowledge if they have been given supervision or instruction concerning use of the appliance in a safe way and understand the hazards involved. Children shall not play with the appliance. Cleaning and user maintenance shall not be made by children without supervision (European Union countries).

This appliance is not intended for use by persons (including children) with reduced physical, sensory or mental capabilities, or lack of experience and knowledge, unless they have been given supervision or instruction concerning use of the appliance by a person responsible for their safety. Children should be supervised to ensure that they do not play with the appliance.

Warnings for product use

- If an abnormal situation arises (like a burning smell), immediately turn off the unit and disconnect the power. Call your dealer for instructions to avoid electric shock, fire or injury.
- **Do not** insert fingers, rods or other objects into the air inlet or outlet. This may cause injury, since the fan may be rotating at high speeds.
- **Do not** use flammable sprays such as hair spray, lacquer or paint near the unit. This may cause fire or combustion.
- **Do not** operate the air conditioner in places near or around combustible gases. Emitted gas may collect around the unit and cause explosion.
- **Do not** operate your air conditioner in a wet room such as a bathroom or laundry room. Too much exposure to water can cause electrical components to short circuit.
- **Do not** expose your body

1 Safety Precautions

directly to cool air for a prolonged period of time.

- **Do not** allow children to play with the air conditioner. Children must be supervised around the unit at all times.
- If the air conditioner is used together with burners or other heating devices, thoroughly ventilate the room to avoid oxygen deficiency.
- In certain functional environments, such as kitchens, server rooms, etc., the use of specially designed air-conditioning units is highly recommended.

Cleaning and maintenance warnings

- Turn off the device and disconnect the power before cleaning. Failure to do so can cause electrical shock.
- **Do not** clean the air conditioner with excessive amounts of water.
- **Do not** clean the air

conditioner with combustible cleaning agents. Combustible cleaning agents can cause fire or deformation.

Caution

- Turn off the air conditioner and disconnect the power if you are not going to use it for a long time.
- Turn off and unplug the unit during storms.
- Make sure that water condensation can drain unhindered from the unit.
- **Do not** operate the air conditioner with wet hands. This may cause electric shock.
- **Do not** use device for any other purpose than its intended use.
- **Do not** climb onto or place objects on top of the outdoor unit.
- **Do not** allow the air conditioner to operate for long periods of time with doors or windows open, or if the humidity is very high.

1 Safety Precautions

Electrical warnings

- Only use the specified power cord. If the power cord is damaged, it must be replaced by the manufacturer, its service agent or similarly qualified persons in order to avoid a hazard.
- Keep power plug clean. Remove any dust or grime that accumulates on or around the plug. Dirty plugs can cause fire or electric shock.
- **Do not** pull power cord to unplug unit. Hold the plug firmly and pull it from the outlet. Pulling directly on the cord can damage it, which can lead to fire or electric shock.
- **Do not** modify the length of the power supply cord or use an extension cord to power the unit.
- **Do not** share the electrical outlet with other appliances. Improper or insufficient power supply can cause fire or electrical shock.
- The product must be properly grounded at the time of installation, or electrical shock may occur.
- For all electrical work, follow all local and national wiring standards, regulations, and the Installation Manual. Connect cables tightly, and clamp them securely to prevent external forces from damaging the terminal. Improper electrical connections can overheat and cause fire, and may also cause shock. All electrical connections must be made according to the Electrical connection diagram located on the panels of the indoor and outdoor units.
- All wiring must be properly arranged to ensure that the control board cover can close properly. If the control board cover is not closed properly, it can lead to corrosion and cause the connection points on the terminal to heat up, catch fire, or cause electrical shock.
- If connecting power to fixed wiring, an all-pole

1 Safety Precautions

disconnection device which has at least 3mm clearances in all poles, and have a leakage current that may exceed 10mA, the residual current device (RCD) having a rated residual operating current not exceeding 30mA, and disconnection must be incorporated in the fixed wiring in accordance with the wiring rules.

Take note of fuse specifications

The air conditioner's circuit board (PCB) is designed with a fuse to provide overcurrent protection. The specifications of the fuse are printed on the circuit board, such as:

T3.15AL/250VAC, T5AL/250VAC, T3.15A/250VAC, T5A/250VAC, T20A/250VAC, T30A/250VAC, etc.



Note: For the units using R32 or R290 refrigerant, only the blast-proof ceramic fuse can be used.

Warnings for product installation

1. Installation must be performed by an authorized dealer or specialist. Defective installation can cause water leakage, electrical shock, or fire.
2. Installation must be performed according to the installation instructions. Improper installation can cause water leakage, electrical shock, or fire.
3. Contact an authorized service technician for repair or maintenance of this unit. This appliance shall be installed in accordance with national wiring regulations.
4. Only use the included accessories, parts, and specified parts for installation. Using non-standard parts can cause water leakage, electrical shock, fire, and can cause the unit to fail.

1 Safety Precautions

5. Install the unit in a firm location that can support the unit's weight. If the chosen location cannot support the unit's weight, or the installation is not done properly, the unit may drop and cause serious injury and damage.
6. Install drainage piping according to the instructions in this manual. Improper drainage may cause water damage to your home and property.
7. For units that have an auxiliary electric heater, **do not** install the unit within 1 meter (3 feet) of any combustible materials.
8. **Do not** install the unit in a location that may be exposed to combustible gas leaks. If combustible gas accumulates around the unit, it may cause fire.
9. Do not turn on the power until all work has been completed.
10. When moving or relocating the air conditioner, consult experienced service technicians for disconnection and reinstallation of the unit.
11. How to install the appliance to its support, please read the information for details in "indoor unit installation" and "outdoor unit installation" sections.

Note about fluorinated gases (Not applicable to the unit using R290 Refrigerant)

1. This air-conditioning unit contains fluorinated greenhouse gases. For specific information on the type of gas and the amount, please refer to the relevant label on the unit itself or the "User Manual - Product Fiche" in the packaging of the outdoor unit. (European Union products only).
2. Installation, service, maintenance and repair of this unit must be performed by a certified technician.
3. Product uninstillation and recycling must be performed by a certified technician.

1 Safety Precautions

4. For equipment that contains fluorinated greenhouse gases in quantities of 5 tonnes of CO₂ equivalent or more, but of less than 50 tonnes of CO₂ equivalent, if the system has a leak-detection system installed, it must be checked for leaks at least every 24 months.
 - operated and stored in a room with a floor area larger than:
 - ≤9000Btu/h units: 13m²
 - >9000Btu/h and ≤12000Btu/h units: 17m²
 - >12000Btu/h and ≤18000Btu/h units: 26m²
 - >18000Btu/h and ≤24000Btu/h units: 35m²
5. When the unit is checked for leaks, proper record-keeping of all checks is strongly recommended.

Warning for Using R32/R290 Refrigerant

- When flammable refrigerant are employed, appliance shall be stored in a well-ventilated area where the room size corresponds to the room area as specific for operation.
For R32 refrigerant models:
Appliance shall be installed, operated and stored in a room with a floor area larger than 4m².
For R290 refrigerant models, appliance shall be installed,
 - Reusable mechanical connectors and flared joints are not allowed indoors. (EN Standard Requirements).
 - Mechanical connectors used indoors shall have a rate of not more than 3g/year at 25% of the maximum allowable pressure. When mechanical connectors are reused indoors, sealing parts shall be renewed. When flared joints are reused indoors, the flare part shall be re-fabricated. (UL Standard Requirements)
 - When mechanical connectors are reused indoors, sealing parts shall be renewed. When flared joints are reused indoors, the

1 Safety Precautions

flare part shall be re-fabricated.
(IEC Standard Requirements)

- Mechanical connectors used indoors shall comply with ISO 14903.

European disposal guidelines

This marking shown on the product or its literature, indicates that waste electrical and electronic equipment should not be mixed with general household waste.

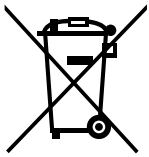

Correct disposal of this product (Waste electrical & Electronic equipment)

 This appliance contains refrigerant and other potentially hazardous materials. When disposing of this appliance, the law requires special collection and treatment. Do not dispose of this product as household waste or unsorted municipal waste.

When disposing of this appliance, you have the following options:











- Dispose of the appliance at designated municipal electronic waste collection facility.
- When buying a new appliance, the retailer will take back the old appliance free of charge.
- The manufacturer will take back the old appliance free of charge. (for some countries)
- Sell the appliance to certified scrap metal dealers. (for some countries)

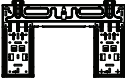

Special notice: Disposing of this appliance in the forest or other natural surroundings endangers your health and is bad for the environment. Hazardous substances may leak into the ground water and enter the food chain.

2 Overview

The air conditioning system comes with the following accessories. Use all of the installation parts and accessories to install the air conditioner. Improper installation may result in water leakage, electrical shock and fire, or cause the equipment to fail. The items are not included with the air conditioner must be purchased separately.

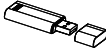
Name of Accessories	Q'ty(pc)	Shape	Name of Accessories	Q'ty(pc)	Shape
Manual	2-3		Remote controller	1	
Drain joint (for cooling & heating models)	1		Battery	2	
Seal (for cooling & heating models)	1		Remote controller holder (optional)	1	
Mounting plate	1		Fixing screw for remote controller holder (optional)	2	
Anchor	5~8 (depending on models)		Small Filter (Need to be installed on the back of main air filter by the authorized technician while installing the machine)	1~2 (depending on models)	
Mounting plate fixing screw	5~8 (depending on models)				
Wireless USB kit	1 (For Wifi models only)				

2 Overview

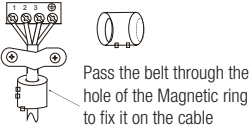
Name	Shape		Quantity(PC)
Connecting pipe assembly	Liquid side	Φ 6.35 (1/4 in)	Parts you must purchase separately. Consult the dealer about the proper pipe size of the unit you purchased.
		Φ 9.52 (3/8in)	
	Gas side	Φ 9.52 (3/8in)	
		Φ 12.7 (1/2in)	
		Φ 16 (5/8in)	
		Φ 19 (3/4in)	
Magnetic ring and belt (if supplied, please refer to the wiring diagram to install it on the connective cable)			Varies by model

2.1 Unit parts



The installation must be performed in accordance with the requirement of local and national standards. The installation may be slightly different in different areas.

2 Overview

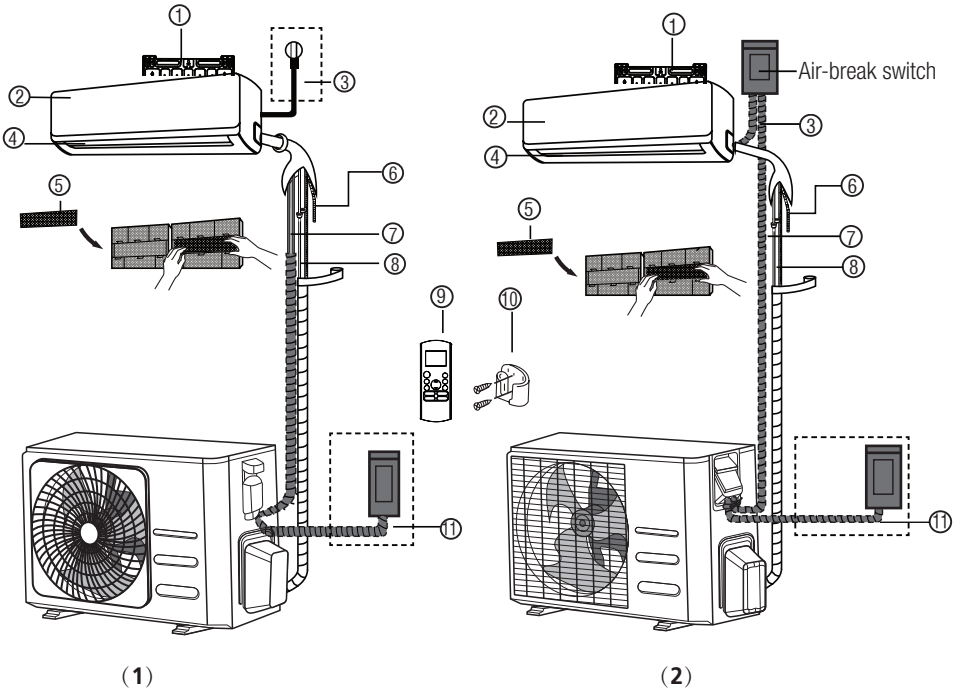

2.2 Controls and parts

1. Wall mounting plate
2. Front panel
3. Power cable (some units)
4. Louver
5. Functional Filter (On Back of Main Filter - Some Units)
6. Drainage pipe
7. Signal cable
8. Refrigerant piping
9. Remote controller
10. Remote controller holder (some units)
11. Outdoor unit power cable (some units)

Illustrations in this manual are for explanatory purposes. The actual shape of your indoor unit may be slightly different. The actual shape shall prevail.

3 Unit specifications and features

3.1 Indoor unit display

 Different models have different front panel and display window. Not all the indicators describing below are available for the air conditioner you purchased. Please check the indoor display window of the unit you purchased.

 Illustrations in this manual are for explanatory purposes. The actual shape of your indoor unit may be slightly different. The actual shape shall prevail.

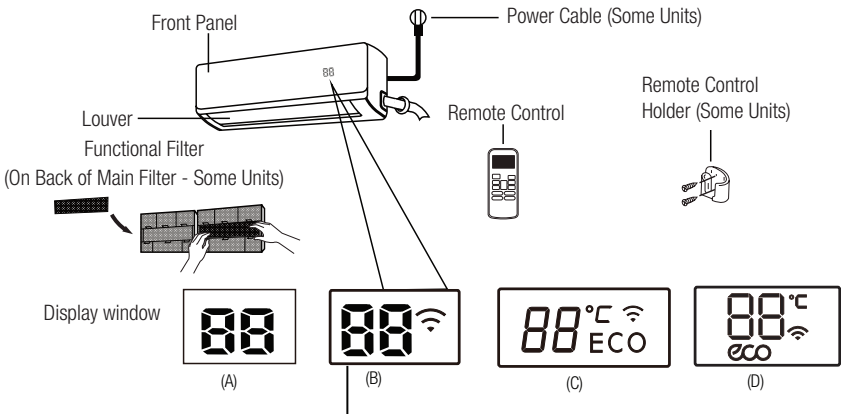

- “ **ECO** ” when ECO function is activated (some units)
- “ **°C** ” Lights up in different colour according to the operation mode (some units):
Under COOL and DRY mode, it displays as cool colour.
Under HEAT mode, it displays as warm colour.
- “  ” when Wireless Control feature is activated (some units)
- “ **88** ” Displays temperature, operation feature and Error codes:
- “ **01** ” for 3 seconds when:
- TIMER ON is set (if the unit is OFF, “**01**” remains on when TIMER ON is set)
 - FRESH, SWING, TURBO, SILENCE or SOLAR PV ECO feature is turned on “**0F**” for 3 seconds when:
 - TIMER OFF is set
 - FRESH, SWING, TURBO, SILENCE or SOLAR PV ECO feature is turned off
- “ **CF** ” when anti-cold air feature is turned on
- “ **df** ” when defrosting (cooling & heating units)
- “ **SC** ” when unit is self-cleaning
- “ **FP** ” when 8 °C heating feature is turned on

Display Code Meanings

3 Unit specifications and features

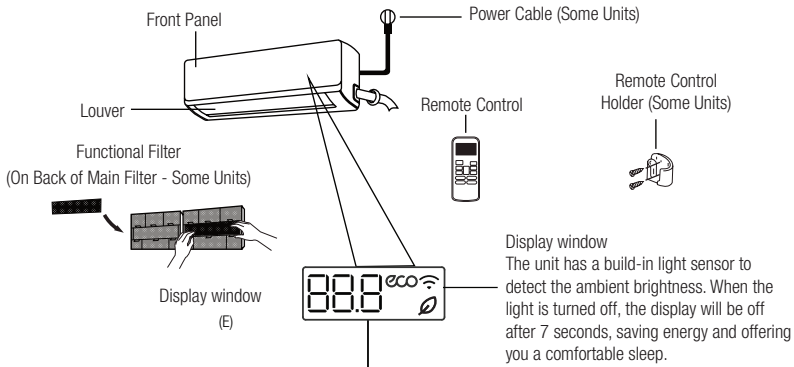

"88.8" Displays temperature, operation feature and Error codes:

"00" for 3 seconds when:

- TIMER ON is set (if the unit is OFF, "00" remains on when TIMER ON is set)
- FRESH, SWING, TURBO, or SILENCE features is turned on

"0F" for 3 seconds when:

- TIMER OFF is set
- FRESH, SWING, TURBO, or SILENCE features is turned off

"dF" when defrosting (for cooling & heating units)

"SE" when unit is self-cleaning (some units)

"FF" when 8°C (46°F) or 12°C (54°F) heating mode is turned on (some units)

"∅" when fresh feature is turned on (some units)

"ECO" when ECO feature is activated (some units)

"📶" when wireless control feature is activated (some units)

Display Code Meanings

In Fan mode, the unit will display the room temperature.

In other modes, the unit will display your temperature setting.

Press the LED button on the remote control will turn off the display screen, press the LED button again during 15 seconds will display the room temperature, if press it again after 15 seconds, it will turn on the display screen.

3.2 Operating temperature

When your air conditioner is used outside of the following temperature ranges, certain safety protection features may activate and cause the unit to disable.

3 Unit specifications and features

3.3 Inverter Split type

	COOL mode	HEAT mode	DRY mode
Room Temperature	17°C - 32°C (62°F - 90°F)	0°C - 30°C (32°F - 86°F)	10°C - 32°C (50°F - 90°F)
Outdoor Temperature	0°C - 50°C (32°F - 122°F)	-15°C - 30°C (5°F - 86°F)	0°C - 50°C (32°F - 122°F)
	-15°C - 50°C (5°F - 122°F) (For models with low temp. cooling systems.)		0°C - 52°C (32°F - 126°F) (For special tropical models)
	0°C - 52°C (32°F - 126°F) (For special tropical models)		



For outdoor units with auxiliary electric heater. When outside temperature is below 0°C (32°F), we strongly recommend keeping the unit plugged in at all time to ensure smooth ongoing performance.

3.4 Fixed-speed type

	COOL mode	HEAT mode	DRY mode
Room Temperature	17°C-32°C (62°F-90°F)	0°C-30°C (32°F-86°F)	10°C-32°C (50°F-90°F)
Outdoor Temperature	18°C-43°C (64°F-109°F)	-7°C-24°C (19°F-75°F)	11°C-43°C (52°F-109°F)
	-7°C-43°C (19°F- 109°F) (For models with low-temp cooling systems)		18°C-43°C (64°F-109°F)
	18°C-52°C (64°F -126°F) (For special tropical models)		18°C-52°C (64°F - 126°F) (For special tropical models)

3 Unit specifications and features



Room relative humidity less than 80%. If the air conditioner operates in excess of this figure, the surface of the air conditioner may attract condensation. Please sets the vertical air flow louver to its maximum angle (vertically to the floor), and set HIGH fan mode.

To further optimize the performance of your unit, do the following

- Keep doors and windows closed.
- Limit energy usage by using TIMER ON and TIMER OFF functions.
- Do not block air inlets or outlets.
- Regularly inspect and clean air filters.

A guide on using the infrared remote is not included in this literature package. Not all the functions are available for the air conditioner, please check the indoor display and remote control of the unit you purchased.

3.5 Other features

• Auto-Restart (some units)

If the unit loses power, it will automatically restart with the prior settings once power has been restored.

• Anti-mildew (some units)

When turning off the unit from COOL, AUTO (COOL), or DRY modes, the air conditioner will continue operate at very low power to dry up condensed water and prevent mildew growth.

• Wireless Control (some units)

Wireless control allows you to control your air conditioner using your mobile phone and a wireless connection.

For the USB device access, replacement, maintenance operations must be carried out by professional staff.

• Louver Angle Memory (some units)

When turning on your unit, the louver will automatically resume its former angle.

• Refrigerant Leakage Detection (some units)

The indoor unit will automatically display “EC” or “ELOC” or flash LEDS (some units) when it detects refrigerant leakage.

• Sleep Operation

The SLEEP function is used to decrease energy use while you sleep (and don't need the same temperature settings to stay comfortable). This function can only be activated via remote control. And the Sleep function is not available in FAN or DRY mode.

Press the SLEEP button when you are ready to go to sleep. When in COOL mode, the unit will increase the temperature by 1°C (2°F) after 1 hour, and will increase an additional 1°C (2°F) after another hour. When in HEAT mode, the unit will decrease the temperature by 1°C (2°F) after 1 hour, and will decrease an additional 1°C (2°F) after another hour. The sleep feature will stop after 8 hours and the system will keep running with final situation.

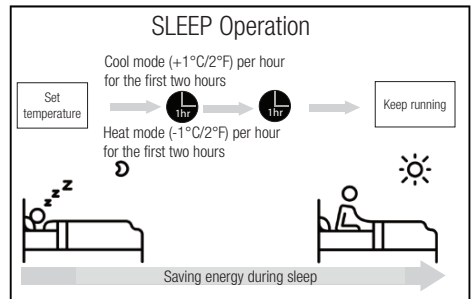

3 Unit specifications and features

3.6 Setting angle of air flow

3.6.1 Setting vertical angle of air flow

While the unit is on, use the SWING/DIRECT button on remote control to set the direction (vertical angle) of airflow. Please refer to the Remote Control Manual for details.



When using COOL or DRY mode, do not set louver at too vertical an angle for long periods of time. This can cause water to condense on the louver blade, which will drop on your floor or furnishings. When using COOL or HEAT mode, setting the louver at too vertical an angle can reduce the performance of the unit due to restricted air flow.

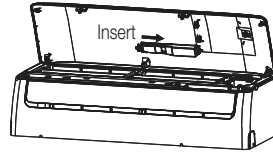
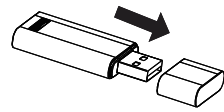

Warning:

This interface is only compatible with HomeWhiz kit (wireless module) provided by the manufacturer.

3.6.2 Setting horizontal angle of air flow

The horizontal angle of the airflow must be set manually. Grip the deflector rod (See Fig.B) and manually adjust it to your preferred direction. For some units, the horizontal angle of the airflow can be set by remote control. please refer to the Remote Control Manual.

3.7 Install the HomeWhiz kit (wireless module)

1. Remove the protective cap of the HomeWhiz kit (wireless module)
2. Open the front panel and insert the HomeWhiz kit (wireless module) into the reserved interface.

3.8 Manual operation (without remote)



CAUTION! The manual button is intended for testing purposes and emergency operation only. Please do not use this function unless the remote control is lost and it is absolutely necessary. To restore regular operation, use the remote control to activate the unit. Unit must be turned off before manual operation.

To operate your unit manually:

1. Open the front panel of the indoor unit.
2. Locate the manual control button on the right-hand side of the unit.
3. Press the manual control button one time to activate forced auto mode.
4. Press the manual control button again to activate forced cooling mode.

3 Unit specifications and features

5. Press the manual control button a third time to turn the unit off.
6. Close the front panel.

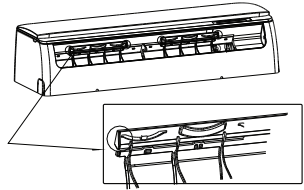
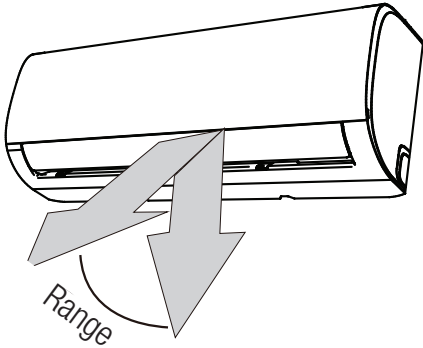
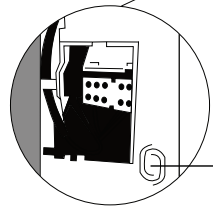
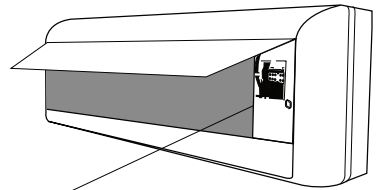

Fig.B



Manual control button



Do not move louver by hand. This will cause the louver to become out of sync. If this occurs, turn off the unit and unplug it for a few seconds, then restart the unit. This will reset the louver.



CAUTION! Do not put your fingers in or near the blower and suction side of the unit. The high-speed fan inside the unit may cause injury.

4 Installation

4.1 Installation summary - indoor unit

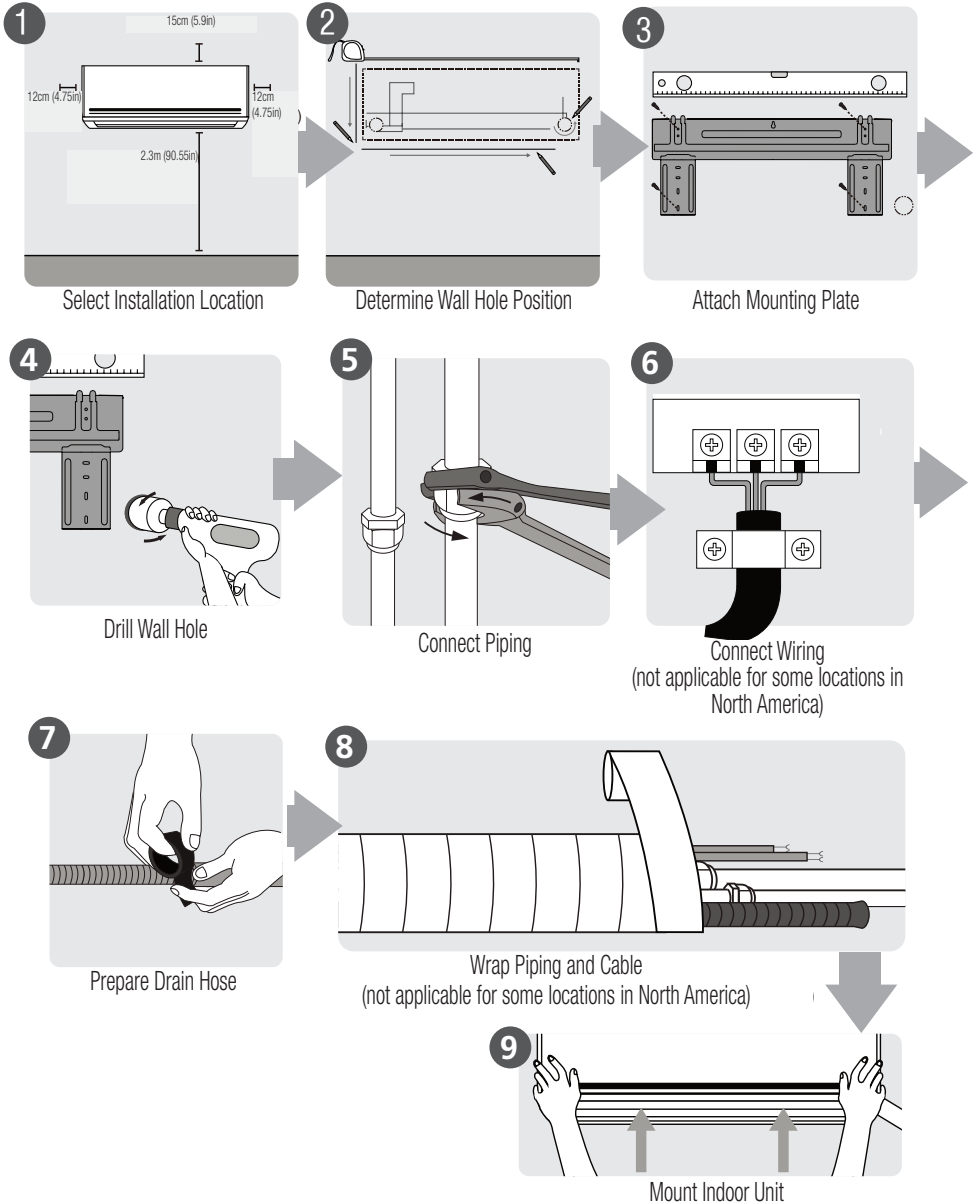

4 Installation

4.2 Installation Instructions – Indoor unit

4.2.1 Prior to installation

Before installing the indoor unit, refer to the label on the product box to make sure that the model number of the indoor unit matches the model number of the outdoor unit.

Step 1: Select installation location Before installing the indoor unit, you must choose an appropriate location. The following are standards that will help you choose an appropriate location for the unit.

Proper installation locations meet the following standards:

- Good air circulation
- Convenient drainage
- Noise from the unit will not disturb other people
- Firm and solid—the location will not vibrate
- Strong enough to support the weight of the unit
- A location at least one meter from all other electrical devices (e.g., TV, radio, computer)

DO NOT install unit in the following locations:

- Near any source of heat, steam, or combustible gas
- Near flammable items such as curtains or clothing
- Near any obstacle that might block air circulation
- Near the doorway
- In a location subject to direct sunlight



If there is no fixed refrigerant piping: While choosing a location, be aware that you should leave ample room for a wall hole (see Drill wall hole for connective piping step) for the signal cable and refrigerant piping that connect the indoor and outdoor units. The default position for all piping is the right side of the indoor unit (while facing the unit). However, the unit can accommodate piping to both the left and right.

Refer to the following diagram to ensure proper distance from walls and ceiling:

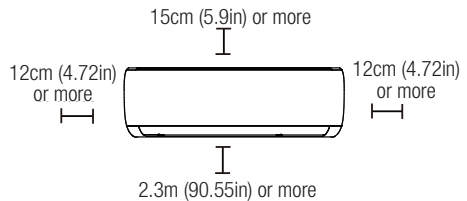

Step 2: Attach mounting plate to wall

The mounting plate is the device on which you will mount the indoor unit.

- Remove the screw that attaches the mounting plate to the back of the indoor unit.

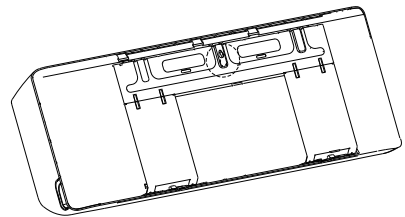

- Secure the mounting plate to the wall with the screws provided. Make sure that mounting plate is flat against the wall.

4 Installation



If the wall is made of brick, concrete, or similar material, drill 5mm-diameter (0.2in-diameter) holes in the wall and insert the sleeve anchors provided. Then secure the mounting plate to the wall by tightening the screws directly into the clip anchors.

Step 3: Drill wall hole for connective piping

1. Determine the location of the wall hole based on the position of the mounting plate. Refer to Mounting Plate Dimensions.
2. Using a 65mm (2.5in) or 90mm (3.54in) (depending on models) core drill, drill a hole in the wall. Make sure that the hole is drilled at a slight downward angle, so that the outdoor end of the hole is lower than the indoor end by about 5mm to 7mm (0.2-0.275in). This will ensure proper water drainage.
3. Place the protective wall cuff in the hole. This protects the edges of the hole and will help seal it when you finish the installation process.



CAUTION! When drilling the wall hole, make sure to avoid wires, plumbing, and other sensitive components.

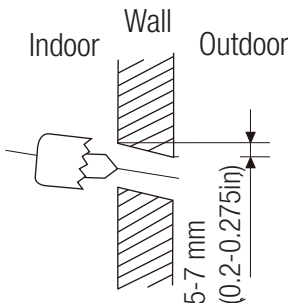

4.2.2 Mounting plate dimensions

Different models have different mounting plates. For the different customization requirements, the shape of the mounting plate may be slightly different. But the installation dimensions are the same for the same size of indoor unit. See Type A and Type B for example:

Correct orientation of Mounting Plate

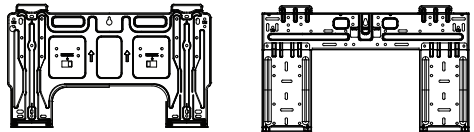
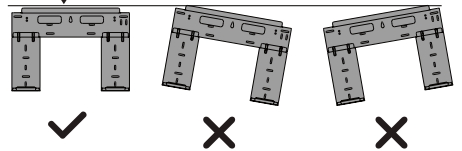

Type A

Type B

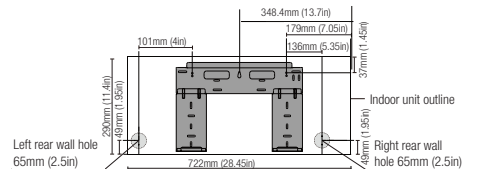

Model A

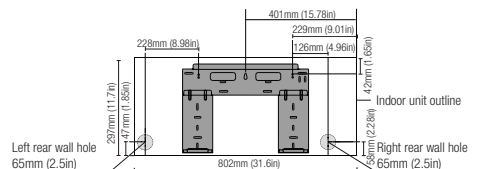

Model B

4 Installation

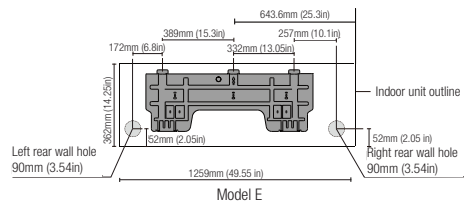
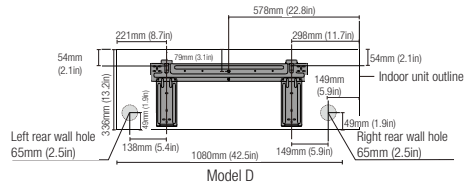
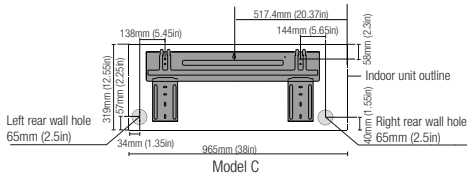

When the gas side connective pipe is 16mm(5/8in) or more, the wall hole should be 90mm (3.54in).

Step 4: Prepare refrigerant piping

The refrigerant piping is inside an insulating sleeve attached to the back of the unit. You must prepare the piping before passing it through the hole in the wall.

1. Based on the position of the wall hole relative to the mounting plate, choose the side from which the piping will exit the unit.
2. If the wall hole is behind the unit, keep the knock-out panel in place. If the wall hole is to the side of the indoor unit, remove the plastic knock-out panel from that side of the unit. This will create a slot through which your piping can

exit the unit. Use needle nose pliers if the plastic panel is too difficult to remove by hand.

3. Groove has been made in the knock-out panel in order to cut it conveniently. The size of the slot is determined by the diameter of piping.

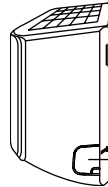

Knock-out Panel

4. If existing connective piping is already embedded in the wall, proceed directly to the Connect Drain Hose step. If there is no embedded piping, connect the indoor unit's refrigerant piping to the connective piping that will join the indoor and outdoor units. Refer to the Refrigerant Piping Connection section of this manual for detailed instructions.



Refrigerant piping can exit the indoor unit from four different angles: Left-hand side, Right-hand side, Left rear, Right rear.

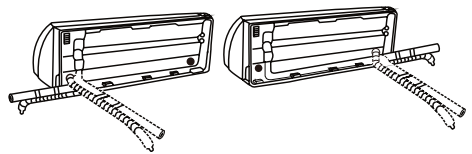

CAUTION! Be extremely careful not to dent or damage the piping while bending them away from the unit. Any dents in the piping will affect the unit's performance.

4 Installation

Step 5: Connect drain hose

By default, the drain hose is attached to the lefthand side of unit (when you're facing the back of the unit). However, it can also be attached to the right-hand side. To ensure proper drainage, attach the drain hose on the same side that your refrigerant piping exits the unit. Attach drain hose extension (purchased separately) to the end of drain hose.

- Wrap the connection point firmly with Teflon tape to ensure a good seal and to prevent leaks.
- For the portion of the drain hose that will remain indoors, wrap it with foam pipe insulation to prevent condensation.
- Remove the air filter and pour a small amount of water into the drain pan to make sure that water flows from the unit smoothly.



Make sure to arrange the drain hose according to the following figures.

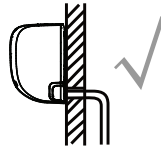

CORRECT

Make sure there are no kinks or dent in drain hose to ensure proper drainage.

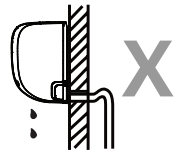

NOT CORRECT

Kinks in the drain hose will create water traps.

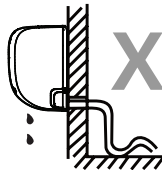

NOT CORRECT

Kinks in the drain hose will create water traps.

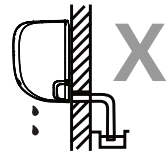

NOT CORRECT

Do not place the end of the drain hose in water or in containers that collect water. This will prevent proper drainage.

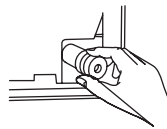

Plug the unused drain hole. To prevent unwanted leaks you must plug the unused drain hole with the rubber plug provided.

4.2.3 Before performing any electrical work, read these regulations

1. All wiring must comply with local and national electrical codes, regulations and must be installed by a licensed electrician.
2. All electrical connections must be made according to the Electrical Connection Diagram located on the panels of the indoor and outdoor units.
3. If there is a serious safety issue with the power supply, stop work immediately. Explain your reasoning to the client, and refuse to install the unit until the safety issue is properly resolved.

4 Installation

4. Power voltage should be within 90-110% of rated voltage. Insufficient power supply can cause malfunction, electrical shock, or fire.
5. If connecting power to fixed wiring, a surge protector and main power switch should be installed.
6. If connecting power to fixed wiring, a switch or circuit breaker that disconnects all poles and has a contact separation of at least 1/8in (3mm) must be incorporated in the fixed wiring. The qualified technician must use an approved circuit breaker or switch.
7. Only connect the unit to an individual branch circuit outlet. Do not connect another appliance to that outlet.
8. Make sure to properly ground the air conditioner.
9. Every wire must be firmly connected. Loose wiring can cause the terminal to overheat, resulting in product malfunction and possible fire.
10. Do not let wires touch or rest against refrigerant tubing, the compressor, or any moving parts within the unit.
11. If the unit has an auxiliary electric heater, it must be installed at least 1 meter (40in) away from any combustible materials.
12. To avoid getting an electric shock, never touch the electrical components soon after the power supply has been turned off. After turning off the power, always wait 10 minutes or more before you touch the electrical components.



WARNING! Before performing any electrical Or wiring work, turn off the Main power to the system.

Step 6: Connect signal and power cables

The signal cable enables communication between the indoor and outdoor units. You must first choose the right cable size before preparing it for connection.

Cable Types

- Indoor Power Cable (if applicable): H05VV-F or H05V2V2-F
- Outdoor Power Cable: H07RN-F or H05RN-F
- Signal Cable: H07RN-F



In North America, choose the cable type according to the local electrical codes and regulations.

Minimum Cross-Sectional Area of Power and Signal Cables (For reference) (Not applicable for North America)

Rated Current of Appliance (A)	Nominal Cross-Sectional Area (mm ²)
> 3 and ≤ 6	0.75
> 6 and ≤ 10	1
> 10 and ≤ 16	1.5
> 16 and ≤ 25	2.5
> 25 and ≤ 32	4
> 32 and ≤ 40	6

The size of the power supply cable, signal cable, fuse, and switch needed is determined by the maximum current of the unit. The maximum current is indicated on the nameplate located on the side panel of the unit. Refer to this nameplate to choose the right cable, fuse, or switch.

4 Installation



In North America, please choose the right cable size according to the Minimum Circuit Ampacity indicated on the nameplate of the unit.

1. Open front panel of the indoor unit.
2. Using a screwdriver, open the wire box cover on the right side of the unit. This will reveal the terminal block.

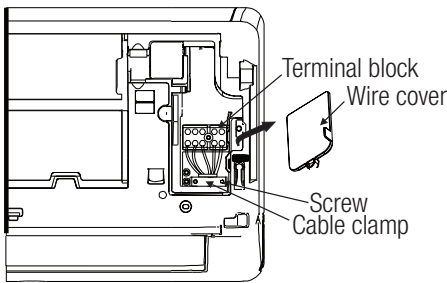

CAUTION! Do not mix up live and null wires. This is dangerous, and can cause the air conditioning unit to malfunction.

7. After checking to make sure every connection is secure, use the cable clamp to fasten the signal cable to the unit. Screw the cable clamp down tightly.
8. Replace the wire cover on the front of the unit, and the plastic panel on the back.



The wiring connection process may differ slightly between units and regions.



WARNING! All wiring must be performed strictly in accordance with the wiring diagram located on the back of the indoor units front panel.

3. Unscrew the cable clamp below the terminal block and place it to the side.
4. Facing the back of the unit, remove the plastic panel on the bottom left-hand side.
5. Feed the signal wire through this slot, from the back of the unit to the front.
6. Facing the front of the unit, connect the wire according to the indoor unit's wiring diagram, connect the u-lug and firmly screw each wire to its corresponding terminal.

Step 7: Wrapping and cables

Before passing the piping, drain hose, and the signal cable through the wall hole, you must bundle them together to save space, protect them, and insulate them (Not applicable in North America).

1. Bundle the drain hose, refrigerant pipes, and signal cable as shown below:

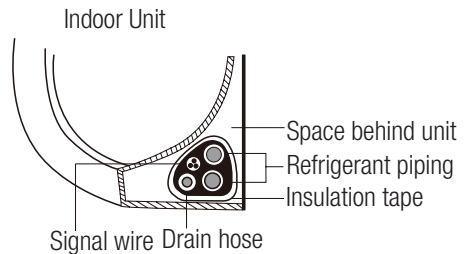

4 Installation



Make sure that the drain hose is at the bottom of the bundle. Putting the drain hose at the top of the bundle can cause the drain pan to overflow, which can lead to fire or water damage.



CAUTION! While bundling these items together, do not intertwine or cross the signal cable with any other wiring.

- Using adhesive vinyl tape, attach the drain hose to the underside of the refrigerant pipes.
- Using insulation tape, wrap the signal wire, refrigerant pipes, and drain hose tightly together. Double-check that all items are bundled.



CAUTION! When wrapping the bundle, keep the ends of the piping unwrapped. You need to access them to test for leaks at the end of the installation process (refer to Electrical Checks and Leak Checks section of this manual).

Step 8: Mount indoor unit

If you installed new connective piping to the outdoor unit, do the following:

- If you have already passed the refrigerant piping through the hole in the wall, proceed to Step 4.
- Otherwise, double-check that the ends of the refrigerant pipes are sealed to prevent dirt or foreign materials from entering the pipes.
- Slowly pass the wrapped bundle of refrigerant pipes, drain hose, and signal wire through the hole in the wall.

- Hook the top of the indoor unit on the upper hook of the mounting plate.
- Check that unit is hooked firmly on mounting by applying slight pressure to the left and right-hand sides of the unit. The unit should not jiggle or shift.
- Using even pressure, push down on the bottom half of the unit. Keep pushing down until the unit snaps onto the hooks along the bottom of the mounting plate.
- Again, check that the unit is firmly mounted by applying slight pressure to the left and the right-hand sides of the unit.

If refrigerant piping is already embedded in the wall, do the following:

- Hook the top of the indoor unit on the upper hook of the mounting plate.
- Use a bracket or wedge to prop up the unit, giving you enough room to connect the refrigerant piping, signal cable, and drain hose.

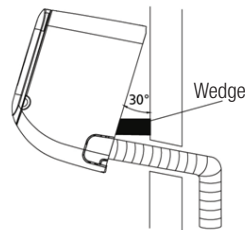

- Connect drain hose and refrigerant piping (refer to Refrigerant Piping Connection section of this manual for instructions).
- Keep pipe connection point exposed to perform the leak test (refer to Electrical Checks and Leak Checks section of this manual).
- After the leak test, wrap the connection point with insulation tape.
- Remove the bracket or wedge that is propping up the unit.

4 Installation

7. Using even pressure, push down on the bottom half of the unit. Keep pushing down until the unit snaps onto the hooks along the bottom of the mounting plate.



Keep in mind that the hooks on the mounting plate are smaller than the holes on the back of the unit. If you find that you don't have ample room to connect embedded pipes to the indoor unit, the unit can be adjusted left or right by about 30-50 mm (1.18-1.95in), depending on the model.

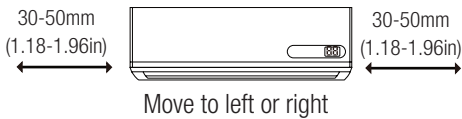

4.3 Outdoor Unit Installation

Install the unit by following local codes and regulations, there may differ slightly between different regions.

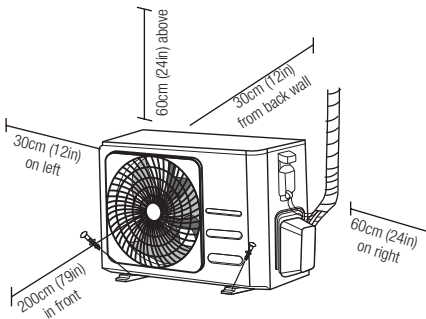

4.3.1 Installation Instructions – Outdoor unit

Step 1: Select installation location

Before installing the outdoor unit, you must choose an appropriate location. The following are standards that will help you choose an appropriate location for the unit.

Proper installation locations meet the following standards:

- Meets all spatial requirements shown in Installation Space Requirements above.
- Good air circulation and ventilation
- Firm and solid—the location can support the unit and will not vibrate
- Noise from the unit will not disturb others
- Protected from prolonged periods of direct sunlight or rain
- Where snowfall is anticipated, raise the unit above the base pad to prevent ice buildup and coil damage. Mount the unit high enough to be above the average accumulated area snowfall. The minimum height must be 18 inches.

DO NOT install unit in the following locations:

- Near an obstacle that will block air inlets and outlets
- Near a public street, crowded areas, or where noise from the unit will disturb others
- Near animals or plants that will be harmed by hot air discharge
- Near any source of combustible gas
- In a location that is exposed to large amounts of dust.
- In a location exposed to a excessive amounts of salty air.

4 Installation



If the unit is exposed to heavy wind: Install unit so that air outlet fan is at a 90° angle to the direction of the wind. If needed, build a barrier in front of the unit to protect it from extremely heavy winds. See Figures below.

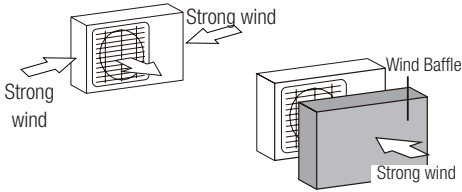

If the unit is frequently exposed to heavy rain or snow: Build a shelter above the unit to protect it from the rain or snow. Be careful not to obstruct air flow around the unit. If the unit is frequently exposed to salty air (seaside): Use outdoor unit that is specially designed to resist corrosion.

Step 2: Install drain joint (Heat pump unit only)

Before bolting the outdoor unit in place, you must install the drain joint at the bottom of the unit. Note that there are two different types of drain joints depending on the type of outdoor unit.

If the drain joint comes with a rubber seal (see Fig. A), do the following:

1. Fit the rubber seal on the end of the drain joint that will connect to the outdoor unit.
2. Insert the drain joint into the hole in the base pan of the unit.
3. Rotate the drain joint 90° until it clicks in place facing the front of the unit.
4. Connect a drain hose extension (not included) to the drain joint to redirect water from the unit during heating mode.

If the drain joint doesn't come with a rubber seal (see Fig. B), do the following:

1. Insert the drain joint into the hole in the base pan of the unit. The drain joint will click in place.
2. Connect a drain hose extension (not included) to the drain joint to redirect water from the unit during heating mode.

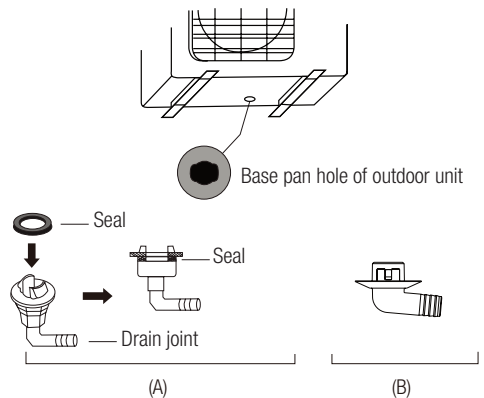

4 Installation



CAUTION! In cold climates, make sure that the drain hose is as vertical as possible to ensure swift water drainage. If water drains too slowly, it can freeze in the hose and flood the unit.

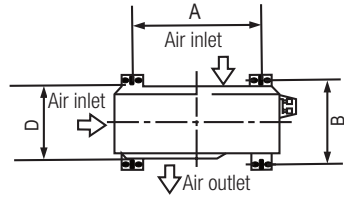

Step 3: Anchor outdoor unit

The outdoor unit can be anchored to the ground or to a wall-mounted bracket with bolt(M10). Prepare the installation base of the unit according to the dimensions below.

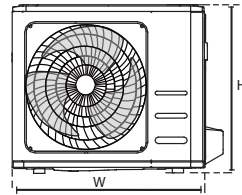

The following is a list of different outdoor unit sizes and the distance between their mounting feet. Prepare the installation base of the unit according to the dimensions below.

Outdoor Unit Dimensions (mm)	Mounting Dimensions	
	W x H x D	Distance A (mm)
681x434x285 (26.8"x 17.1"x 11.2")	460 (18.1")	292 (11.5")
700x550x270 (27.5"x 21.6"x 10.6")	450 (17.7")	260 (10.2")
700x550x275 (27.5"x 21.6"x 10.8")	450 (17.7")	260 (10.2")
720x495x270 (28.3"x 19.5"x 10.6")	452 (17.8")	255 (10.0")
728x555x300 (28.7"x 21.8"x 11.8")	452 (17.8")	302(11.9")
765x555x303 (30.1"x 21.8"x 11.9")	452 (17.8")	286(11.3")
770x555x300 (30.3"x 21.8"x 11.8")	487 (19.2")	298 (11.7")
805x554x330 (31.7"x 21.8"x 12.9")	511 (20.1")	317 (12.5")
800x554x333 (31.5"x 21.8"x 13.1")	514 (20.2")	340 (13.4")
845x702x363 (33.3"x 27.6"x 14.3")	540 (21.3")	350 (13.8")
890x673x342 (35.0"x 26.5"x 13.5")	663 (26.1")	354 (13.9")
946x810x420 (37.2"x 31.9"x 16.5")	673 (26.5")	403 (15.9")
946x810x410 (37.2"x 31.9"x 16.1")	673 (26.5")	403 (15.9")

4 Installation

If you will install the unit on the ground or on a concrete mounting platform, do the following:

1. Mark the positions for four expansion bolts based on dimensions chart.
2. Pre-drill holes for expansion bolts.
3. Place a nut on the end of each expansion bolt.
4. Hammer expansion bolts into the pre-drilled holes.
5. Remove the nuts from expansion bolts, and place outdoor unit on bolts.
6. Put washer on each expansion bolt, then replace the nuts.
7. Using a wrench, tighten each nut until snug.



WARNING! When drilling into concrete, eye protection is recommended at all times.

If you will install the unit on a wall-mounted bracket, do the following:



CAUTION! Make sure that the wall is made of solid brick, concrete, or of similarly strong material. The wall must be able to support at least four times the weight of the unit.

1. Mark the position of bracket holes based on dimensions chart.
2. Pre-drill the holes for the expansion bolts.
3. Place a washer and nut on the end of each expansion bolt.
4. Thread expansion bolts through holes in mounting brackets, put mounting brackets in position, and hammer expansion bolts into the wall.
5. Check that the mounting brackets are level.

6. Carefully lift unit and place its mounting feet on brackets.
7. Bolt the unit firmly to the brackets.
8. If allowed, install the unit with rubber gaskets to reduce vibrations and noise.

Step 4: Connect signal and power cables

The outside unit's terminal block is protected by an electrical wiring cover on the side of the unit.

A comprehensive wiring diagram is printed on the inside of the wiring cover.



WARNING! Before performing any electrical or wiring work, turn off the main power to the system.

1. Prepare the cable for connection: Please choose the right cable refer to "Cable types" in page 26.



The size of the power supply cable, signal cable, fuse, and switch needed is determined by the maximum current of the unit. The maximum current is indicated on the nameplate located on the side panel of the unit.



In North America, please choose the right cable size according to the minimum circuit ampacity indicated on the nameplate of the unit.

- Using wire strippers, strip the rubber jacket from both ends of cable to reveal about 40mm (1.57in) of the wires inside.
- Strip the insulation from the ends of the wires.
- Using a wire crimper, crimp u-lugs on the ends of the wires.

4 Installation



While crimping wires, make sure you clearly distinguish the Live ("L") Wire from other wires.



If the cable clamp looks like the following, please select the appropriate through-hole according to the diameter of the wire.



WARNING! All wiring work must be performed strictly in accordance with the wiring diagram located inside of wire cover of the outdoor unit.

2. Unscrew the electrical wiring cover and remove it.
3. Unscrew the cable clamp below the terminal block and place it to the side.
4. Connect the wire according to the wiring diagram, and firmly screw the u-lug of each wire to its corresponding terminal.
5. After checking to make sure every connection is secure, loop the wires around to prevent rain water from flowing into the terminal.
6. Using the cable clamp, fasten the cable to the unit. Screw the cable clamp down tightly.
7. Insulate unused wires with PVC electrical tape. Arrange them so that they do not touch any electrical or metal parts.
8. Replace the wire cover on the side of the unit, and screw it in place.

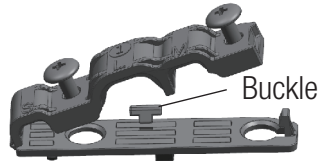
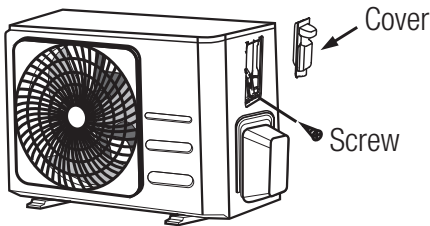

Three size hole: Small, Large, Medium

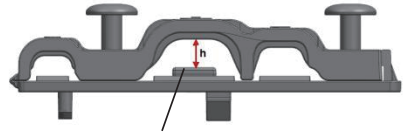

When the cable is not fasten enough, use the buckle to prop it up, so it can be clamped tightly.

In North America

1. Remove the wire cover from the unit by loosening the 3 screws.
2. Dismount caps on the conduit panel.
3. Temporarily mount the conduit tubes (not included) on the conduit panel.
4. Properly connect both the power supply and low voltage lines to the corresponding terminals on the terminal block.
5. Ground the unit in accordance with local codes.
6. Be sure to size each wire allowing several inches longer than the required length for wiring.
7. Use lock nuts to secure the conduit tubes.

4 Installation

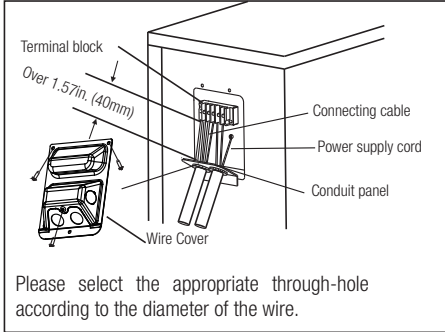

5 Refrigerant piping connection

When connecting refrigerant piping, do not let substances or gases other than the specified refrigerant enter the unit. The presence of other gases or substances will lower the unit's capacity, and can cause abnormally high pressure in the refrigeration cycle. This can cause explosion and injury.



The length of refrigerant piping will affect the performance and energy efficiency of the unit. Nominal efficiency is tested on units with a pipe length of 5 meters (16.5ft) (In North America, the standard pipe length is 7.5m (25')). A minimum pipe run of 3 metres is required to minimise vibration & excessive noise. In special tropical area, for the R290 refrigerant models, no refrigerant can be added and the maximum length of refrigerant pipe should not exceed 10 meters (32.8ft).

Refer to the table below for specifications on the maximum length and drop height of piping.
Maximum Length and Drop Height of Refrigerant Piping per Unit Model

Model	Capacity (BTU/h)	Max. Length (m)	Max. Drop Height (m)
R410A,R32 Inverter Split Air Conditioner	< 15,000	25 (82ft)	10 (33ft)
	≥ 15,000 and < 24,000	30 (98.5ft)	20 (66ft)
	≥ 24,000 and < 36,000	50 (164ft)	25 (82ft)
R22 Fixed-speed Split Air Conditioner	< 18,000	10 (33ft)	5 (16ft)
	≥ 18,000 and < 21,000	15 (49ft)	8 (26ft)
	≥ 21,000 and < 35,000	20 (66ft)	10 (33ft)
R410A, R32 Fixed-speed Split Air Conditioner	< 18,000	20 (66ft)	8 (26ft)
	≥ 18,000 and < 36,000	25 (82ft)	10 (33ft)

5 Refrigerant piping connection

5.1 Connection Instructions – Refrigerant Piping

Step 1: Cut pipes

When preparing refrigerant pipes, take extra care to cut and flare them properly. This will ensure efficient operation and minimize the need for future maintenance.

1. Measure the distance between the indoor and outdoor units.
2. Using a pipe cutter, cut the pipe a little longer than the measured distance.
3. Make sure that the pipe is cut at a perfect 90° angle.

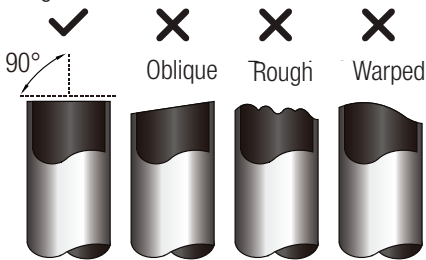

 **WARNING!** Be extra careful not to damage, dent, or deform the pipe while cutting. This will drastically reduce the heating efficiency of the unit.

Step 2: Remove burrs

Burrs can affect the air-tight seal of refrigerant piping connection. They must be completely removed.

1. Hold the pipe at a downward angle to prevent burrs from falling into the pipe.
2. Using a reamer or deburring tool, remove all burrs from the cut section of the pipe.

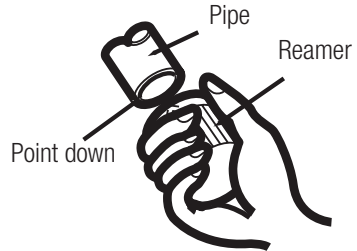

Step 3: Flare pipe ends

Proper flaring is essential to achieve an airtight seal.

1. After removing burrs from cut pipe, seal the ends with PVC tape to prevent foreign materials from entering the pipe.
2. Sheath the pipe with insulating material.
3. Place flare nuts on both ends of pipe. Make sure they are facing in the right direction, because you can't put them on or change their direction after flaring.

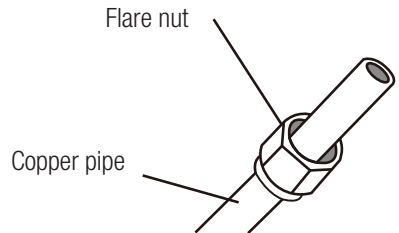

4. Remove PVC tape from ends of pipe when ready to perform flaring work.
5. Clamp flare form on the end of the pipe. The end of the pipe must extend beyond the edge of the flare form in accordance with the dimensions shown in the table below.

5 Refrigerant piping connection

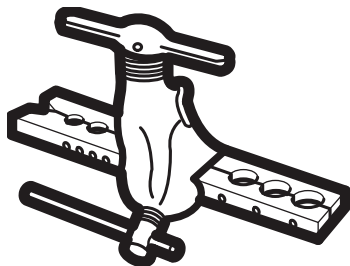

Piping extension beyond flare form

Outer Diameter of Pipe (mm)	A (mm)	
	Min.	Max.
Ø 6.35 (Ø 0.25")	0.7 (0.0275")	1.3 (0.05")
Ø 9.52 (Ø 0.375")	1.0 (0.04")	1.6 (0.063")
Ø12.7 (Ø 0.5")	1.0 (0.04")	1.8 (0.07")
Ø 16 (Ø 0.63")	2.0 (0.078")	2.2 (0.086")
Ø 19 (Ø 0.75")	2.0 (0.078")	2.4 (0.094")

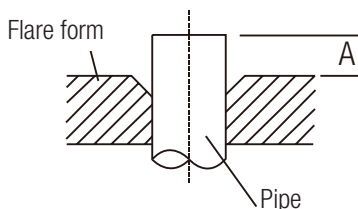

- Place flaring tool onto the form.
- Turn the handle of the flaring tool clockwise until the pipe is fully flared.
- Remove the flaring tool and flare form, then inspect the end of the pipe for cracks and even flaring.

Step 4: Connect pipes

When connecting refrigerant pipes, be careful not to use excessive torque or to deform the piping in any way. You should first connect the low-pressure pipe, then the high-pressure pipe.



When bending connective refrigerant piping, the minimum bending radius is 10cm.

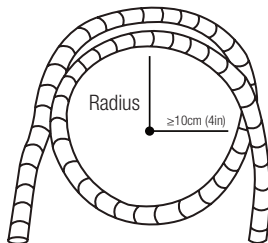

5.2 Instructions for connecting piping to indoor unit

- Align the center of the two pipes that you will connect.

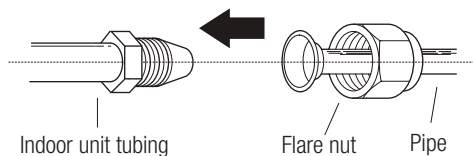

- Tighten the flare nut as tightly as possible by hand.
- Using a spanner, grip the nut on the unit tubing.
- While firmly gripping the nut on the unit tubing, use a torque wrench to tighten the flare nut according to the torque values in the Torque Requirements table below. Loosen the flaring nut slightly, then tighten again.

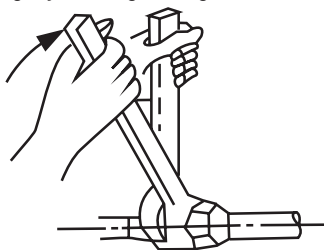

5 Refrigerant piping connection

Torque requirements

Outer Diameter of Pipe (mm)	Tightening Torque (N•m)	Flare dimension(B) (mm)	Flare shape
∅ 6.35 (∅ 0.25")	18~20 (180~200kgf.cm)	8.4~8.7 (0.33~0.34")	
∅ 9.52 (∅ 0.375")	32~39 (320~390kgf.cm)	13.2~13.5 (0.52~0.53")	
∅ 12.7 (∅ 0.5")	49~59 (490~590kgf.cm)	16.2~16.5 (0.64~0.65")	
∅ 16 (∅ 0.63")	57~71 (570~710kgf.cm)	19.2~19.7 (0.76~0.78")	
∅ 19 (∅ 0.75")	67~101 (670~1010kgf.cm)	23.2~23.7 (0.91~0.93")	

 **WARNING!** Excessive force can break the nut or damage the refrigerant piping. You must not exceed torque requirements shown in the table above.

6. Loosen the flaring nut slightly, then tighten again.

7. Repeat Steps 3 to 6 for the remaining pipe.

 **CAUTION!** Torque from tightening the flare nut can snap off other parts of valve.

5.3 Instructions for connecting piping to outdoor unit

1. Unscrew the cover from the packed valve on the side of the outdoor unit.
2. Remove protective caps from ends of valves.
3. Align flared pipe end with each valve, and tighten the flare nut as tightly as possible by hand.
4. Using a spanner, grip the body of the valve. Do not grip the nut that seals the service valve.

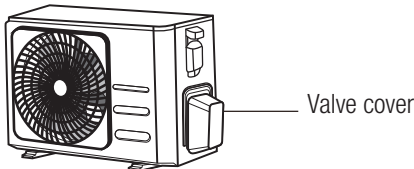
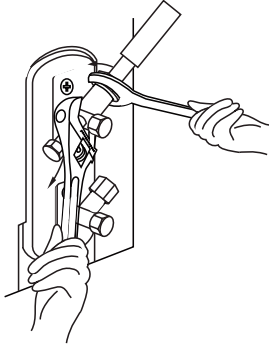

5. While firmly gripping the body of the valve, use a torque wrench to tighten the flare nut according to the correct torque values.

6 Air evacuation

6.1 Preparations and precautions

Air and foreign matter in the refrigerant circuit can cause abnormal rises in pressure, which can damage the air conditioner, reduce its efficiency, and cause injury. Use a vacuum pump and manifold gauge to evacuate the refrigerant circuit, removing any non-condensable gas and moisture from the system.

Evacuation should be performed upon initial installation and when unit is relocated.

6.1.1 Before performing evacuation

- Check to make sure the connective pipes between the indoor and outdoor units are connected properly.
- Check to make sure all wiring is connected properly.

6.1.2 Evacuation instructions

1. connect the charge hose of the manifold gauge to service port on the outdoor unit's low pressure valve.
2. Connect another charge hose from the manifold gauge to the vacuum pump.
3. Open the Low Pressure side of the manifold gauge. Keep the High Pressure side closed.
4. Turn on the vacuum pump to evacuate the system.
5. Run the vacuum for at least 15 minutes, or until the Compound Meter reads -76cmHg (-10^5Pa).

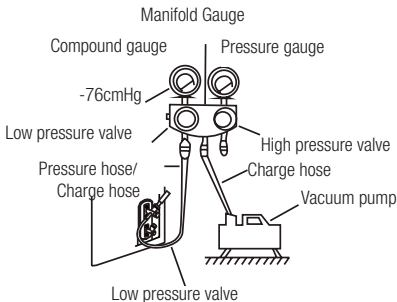

6. Close the Low Pressure side of the manifold gauge, and turn off the vacuum pump.
7. Wait for 5 minutes, then check that there has been no change in system pressure.
8. If there is a change in system pressure, refer to Gas Leak Check section for information on how to check for leaks. If there is no change in system pressure, unscrew the cap from the packed valve (high pressure valve).
9. Insert hexagonal wrench into the packed valve (high pressure valve) and open the valve by turning the wrench in a 1/4 counterclockwise turn. Listen for gas to exit the system, then close the valve after 5 seconds.
10. Watch the Pressure Gauge for one minute to make sure that there is no change in pressure. The Pressure Gauge should read slightly higher than atmospheric pressure.
11. Remove the charge hose from the service port.

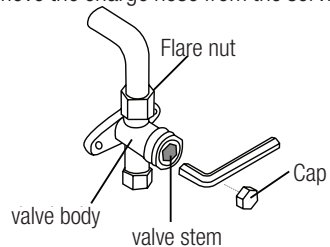

12. Using hexagonal wrench, fully open both the high pressure and low pressure valves.
13. Tighten valve caps on all three valves (service port, high pressure, low pressure) by hand. You may tighten it further using a torque wrench if needed.



CAUTION! When opening valve stems, turn the hexagonal wrench until it hits against the stopper. Do not try to force the valve to open further.

6 Air evacuation

6.1.3 Note on adding refrigerant

Some systems require additional charging depending on pipe lengths. The standard pipe length varies according to local regulations. For example, in North America, the standard pipe

length is 7.5m (25'). In other areas, the standard pipe length is 5m (16'). The refrigerant should be charged from the service port on the outdoor unit's low pressure valve. The additional refrigerant to be charged can be calculated using the following formula:

Additional refrigerant per pipe length

Connective Pipe Length (m)	Air Purging Method	Additional Refrigerant	
< Standard pipe length	Vacuum Pump	N/A	
> Standard pipe length	Vacuum Pump	Liquid Side: Ø 6.35 (ø 0.25") R32: (Pipe length – standard length) x 12g/m (Pipe length – standard length) x 0.13oz/ft R290: (Pipe length – standard length) x 10g/m (Pipe length – standard length) x 0.10oz/ft R410A: (Pipe length – standard length) x 15g/m (Pipe length – standard length) x 0.16oz/ft R22: (Pipe length – standard length) x 20g/m (Pipe length – standard length) x 0.21oz/ft	Liquid Side: Ø 9.52 (ø 0.375") R32: (Pipe length – standard length) x 24g/m (Pipe length – standard length) x 0.26oz/ft (Pipe length – standard length) x 18g/m (Pipe length – standard length) x 0.19oz/ft R410A: (Pipe length – standard length) x 30g/m (Pipe length – standard length) x 0.32oz/ft R22: (Pipe length – standard length) x 40g/m (Pipe length – standard length) x 0.42oz/ft

For R290 refrigerant unit, the total amount of refrigerant to be charged is no more than: 387g (<=9000Btu/h), 447g (>9000Btu/h and <=12000Btu/h), 547g (>12000Btu/h and <=18000Btu/h), 632g (>18000Btu/h and <=24000Btu/h).



CAUTION! DO NOT mix refrigerant types.

7 Electrical and gas leak checks

7.1 Before test run

Only perform test run after you have completed the following steps:

- Electrical Safety Checks – Confirm that the unit's electrical system is safe and operating properly
- Gas Leak Checks – Check all flare nut connections and confirm that the system is not leaking
- Confirm that gas and liquid (high and low pressure) valves are fully open

7.2 Electrical safety checks

After installation, confirm that all electrical wiring is installed in accordance with local and national regulations, and according to the Installation Manual.

Before test run

Check Grounding Work

Measure grounding resistance by visual detection and with grounding resistance tester. Grounding resistance must be less than 0.1. Note: This may not be required for some locations in North America.

During test run

Check for Electrical Leakage

During the Test Run, use an electroprobe and multimeter to perform a comprehensive electrical leakage test.

If electrical leakage is detected, turn off the unit immediately and call a licensed electrician to find and resolve the cause of the leakage.



This may not be required for some locations in North America.



All wiring must comply with local and national electrical codes, and must be installed by a licensed electrician.

7.3 Gas leak checks

There are two different methods to check for gasleaks.

Soap and Water Method

Using a soft brush, apply soapy water or liquid detergent to all pipe connection points on the indoor unit and outdoor unit. The presence of bubbles indicates a leak.

Leak Detector Method

If using leak detector, refer to the device's operation manual for proper usage instructions.



After confirming that the all pipe connection points do not leak, replace the valve cover on the outside unit.

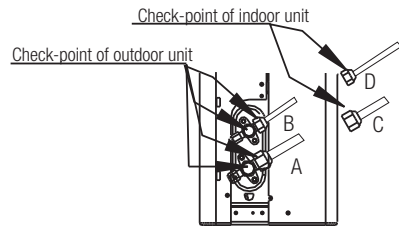

A: Low pressure stop valve
B: High pressure stop valve
C&D: Indoor unit flare nuts

8 Test run

8.1 Test run instructions

You should perform the Test Run for at least 30 minutes.

1. Connect power to the unit.
2. Press the ON/OFF button on the remote controller to turn it on.
3. Press the MODE button to scroll through the following functions, one at a time:
 - COOL – Select lowest possible temperature
 - HEAT – Select highest possible temperature
4. Let each function run for 5 minutes, and perform the following checks:

List of Checks to Perform	PASS/FAIL	
No electrical leakage		
Unit is properly grounded		
All electrical terminals properly covered		
Indoor and outdoor units are solidly installed		
All pipe connection points do not leak	Outdoor (2):	Indoor (2):
Water drains properly from drain hose		
All piping is properly insulated		
Unit performs COOL function properly		
Unit performs HEAT function properly		
Indoor unit louvers rotate properly		
Indoor unit responds to remote controller		



During operation, the pressure of the refrigerant circuit will increase. This may reveal leaks that were not present during your initial leak check. Take time during the Test Run to double-check that all refrigerant pipe connection points do not have leaks. Refer to Gas Leak Check section for instructions.

5. After the Test Run is successfully completed, and you confirm that all checks points in List of Checks to Perform have PASSED, do the following:

- Using remote control, return unit to normal operating temperature.
- Using insulation tape, wrap the indoor refrigerant pipe connections that you left uncovered during the indoor unit installation process.

If ambient temperature is below 17°C (62°F)

You can't use the remote controller to turn on the cool function when the ambient temperature is below 17°C. In this instance, you can use the manual control button to test the cool function.

1. lift the front panel of the indoor unit, and raise it until it clicks in place.
2. The MANUAL CONTROL button is located on the right-hand side of the unit. Press it 2 times to select the COOL function.
3. Perform Test Run as normal.

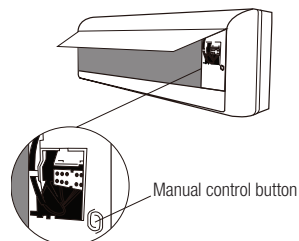

9 Care and maintenance

9.1 Cleaning your indoor unit

 **CAUTION!** Always turn off your air conditioner system and disconnect its power supply before cleaning or maintenance.

 Only use a soft, dry cloth to wipe the unit clean. If the unit is especially dirty, you can use a cloth soaked in warm water to wipe it clean.

 **CAUTION!** Do not use chemicals or chemically treated cloths to clean the unit.

 **CAUTION!** Do not use benzene, paint thinner, polishing powder or other solvents to clean the unit. They can cause the plastic surface to crack or deform.

 **CAUTION!** Do not use water hotter than 40°C (104°F) to clean the front panel. This can cause the panel to deform or become discolored.

5. Clean the large air filter with warm, soapy water. Be sure to use a mild detergent.
6. Rinse the filter with fresh water, then shake off excess water.
7. Dry it in a cool, dry place, and refrain from exposing it to direct sunlight.
8. When dry, re-clip the air freshening filter to the larger filter, then slide it back into the indoor unit.
9. Close the front panel of the indoor unit.

9.2 Cleaning your air filter

A clogged air conditioner can reduce the cooling efficiency of your unit, and can also be bad for your health. Make sure to clean the filter once every two weeks.

1. Lift the front panel of the indoor unit.
2. Grip the tab on the end of the filter, lift it up, then pull it towards yourself.
3. Now pull the filter out.
4. If your filter has a small air freshening filter, unclip it from the larger filter. Clean this air freshening filter with a hand-held vacuum.

9 Care and maintenance

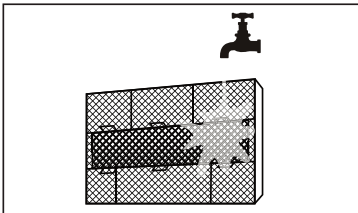
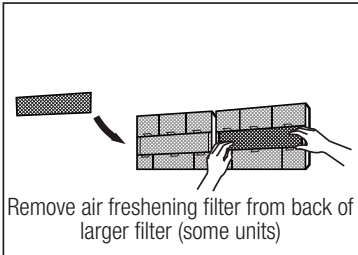
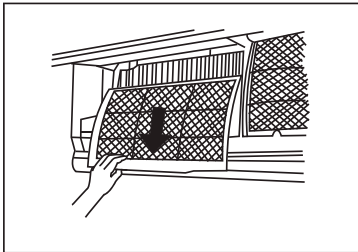
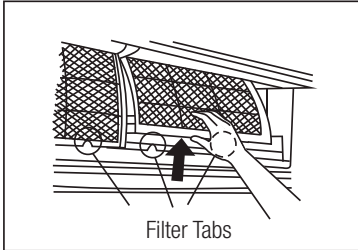

CAUTION!

- Before changing the filter or cleaning, turn off the unit and disconnect its power supply.
- When removing filter, do not touch metal parts in the unit. The sharp metal edges can cut you.
- Do not use water to clean the inside of the indoor unit. This can destroy insulation and cause electrical shock.
- Do not expose filter to direct sunlight when drying. This can shrink the filter.



CAUTION! Do not touch air freshening (Plasma) filter for at least 10 minutes after turning off the unit.

9 Care and maintenance

9.3 Maintenance – long periods of non-use

If you plan not to use your air conditioner for an extended period of time, do the following:

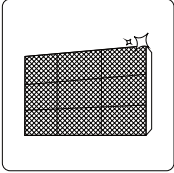

Clean all filters

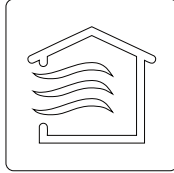

Turn on FAN function until unit dries out completely



Turn off the unit and disconnect the power

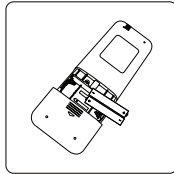

Remove batteries from remote control

9.4 Maintenance – Pre-Season Inspection

After long periods of non-use, or before periods of frequent use, do the following:

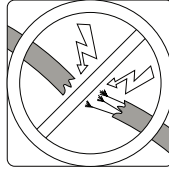

Check for damaged wires

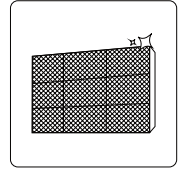

Clean all filters



Check for leaks

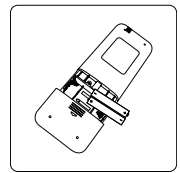

Replace batteries

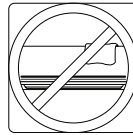

Make sure nothing is blocking all air inlets and outlets

10 Troubleshooting



CAUTION! If any of the following conditions occurs, turn off your unit immediately!

- The power cord is damaged or abnormally warm.
- You smell a burning odor.
- The unit emits loud or abnormal sounds.
- A power fuse blows or the circuit breaker frequently trips.
- Water or other objects fall into or out of the unit.
- Do not attempt to fix these yourself! Contact an authorized Service provider immediately!

10.1 Common issues

The following problems are not a malfunction and in most situations will not require repairs.

Issue	Possible Causes
Unit does not turn on when pressing ON/OFF button	The Unit has a 3-minute protection feature that prevents the unit from overloading. The unit cannot be restarted within three minutes of being turned off.
The unit changes from COOL/HEAT mode to FAN mode	The unit may change its setting to prevent frost from forming on the unit. Once the temperature increases, the unit will start operating in the previously selected mode again.
	The set temperature has been reached, at which point the unit turns off the compressor. The unit will continue operating when the temperature fluctuates again.
The indoor unit emits white mist	In humid regions, a large temperature difference between the room's air and the conditioned air can cause white mist.
Both the indoor and outdoor units emit white mist	When the unit restarts in HEAT mode after defrosting, white mist may be emitted due to moisture generated from the defrosting process.
The indoor unit makes noises	A rushing air sound may occur when the louver resets its position.
	A squeaking sound may occur after running the unit in HEAT mode due to expansion and contraction of the unit's plastic parts.
Both the indoor unit and outdoor unit make noises	Low hissing sound during operation: This is normal and is caused by refrigerant gas flowing through both indoor and outdoor units.
	Low hissing sound when the system starts, has just stopped running, or is defrosting: This noise is normal and is caused by the refrigerant gas stopping or changing direction.
	Squeaking sound: Normal expansion and contraction of plastic and metal parts caused by temperature changes during operation can cause squeaking noises.

10 Troubleshooting

Issue	Possible Causes
The outdoor unit makes noises	The unit will make different sounds based on its current operating mode.
Dust is emitted from either the indoor or outdoor unit	The unit may accumulate dust during extended periods of non-use, which will be emitted when the unit is turned on. This can be mitigated by covering the unit during long periods of inactivity.
The unit emits a bad odor	The unit may absorb odors from the environment (such as furniture, cooking, cigarettes, etc.) which will be emitted during operations.
	The unit's filters have become moldy and should be cleaned.
The fan of the outdoor unit does not operate	During operation, the fan speed is controlled to optimize product operation.
Operation is erratic, unpredictable, or unit is unresponsive	Interference from cell phone towers and remote boosters may cause the unit to malfunction. In this case, try the following: <ul style="list-style-type: none">• Disconnect the power, then reconnect.• Press ON/OFF button on remote control to restart operation.



If problem persists, contact a local dealer or your nearest customer service center. Provide them with a detailed description of the unit malfunction as well as your model number.

10 Troubleshooting

10.2 Troubleshooting

When troubles occur, please check the following points before contacting a repair company.

Problem	Possible Causes	Solution
Poor Cooling Performance	Temperature setting may be higher than ambient room temperature	Lower the temperature setting
	The heat exchanger on the indoor or outdoor unit is dirty	Clean the affected heat exchanger
	The air filter is dirty	Remove the filter and clean it according to instructions
	The air inlet or outlet of either unit is blocked	Turn the unit off, remove the obstruction and turn it back on
	Doors and windows are open	Make sure that all doors and windows are closed while operating the unit
	Excessive heat is generated by sunlight	Close windows and curtains during periods of high heat or bright sunshine
	Too many sources of heat in the room (people, computers, electronics, etc.)	Reduce amount of heat sources
	Low refrigerant due to leak or long-term use	Check for leaks, re-seal if necessary and top off refrigerant
	SILENCE function is activated (optional function)	SILENCE function can lower product performance by reducing operating frequency. Turn off SILENCE function.

10 Troubleshooting

Problem	Possible Causes	Solution
The unit is not working	Power failure	Wait for the power to be restored
	The power is turned off	Turn on the power
	The fuse is burned out	Replace the fuse
	Remote control batteries are dead	Replace batteries
	The Unit's 3-minute protection has been activated	Wait three minutes after restarting the unit
	Timer is activated	Turn timer off
The unit starts and stops frequently	There's too much or too little refrigerant in the system	Check for leaks and recharge the system with refrigerant.
	Incompressible gas or moisture has entered the system.	Evacuate and recharge the system with refrigerant
	The compressor is broken	Replace the compressor
	The voltage is too high or too low	Install a manostat to regulate the voltage
Poor heating performance	The outdoor temperature is extremely low	Use auxiliary heating device
	Cold air is entering through doors and windows	Make sure that all doors and windows are closed during use
	Low refrigerant due to leak or long-term use	Check for leaks, re-seal if necessary and top off refrigerant
Indicator lamps continue flashing	<p>The unit may stop operation or continue to run safely. If the indicator lamps continue to flash or error codes appear, wait for about 10 minutes. The problem may resolve itself. If not, disconnect the power, then connect it again. Turn the unit on. If the problem persists, disconnect the power and contact your nearest customer service center.</p>	
Error code appears and begins with the letters as the following in the window display of indoor unit: E(x), P(x), F(x) EH(xx), EL(xx), EC(xx) PH(xx), PL(xx), PC(xx)		

10 Troubleshooting



If your problem persists after performing the checks and diagnostics above, turn off your unit immediately and contact an authorized service center.

11 European disposal guideline

This appliance contains refrigerant and other potentially hazardous materials. When disposing of this appliance, the law requires special collection and treatment. **Do not** dispose of this product as household waste or unsorted municipal waste,

When disposing of this appliance, you have the following options:

- Dispose of the appliance at designated municipal electronic waste collection facility.
- When buying a new appliance, the retailer will take back the old appliance free of charge.
- The manufacturer will take back the old appliance free of charge.
- Sell the appliance to certified scrap metal dealers.

This symbol indicates that this product shall not be disposed with other household wastes at the end of its service life. Used device must be returned to official collection point for recycling of electrical and electronic devices. To find these collection systems please contact to your local authorities or retailer where the product was purchased. Each household performs important role in recovering and recycling of old appliance. Appropriate disposal of used appliance helps prevent potential negative consequences for the environment and human health.

Special notice



Disposing of this appliance in the forest or other natural surroundings endangers your health and is bad for the environment. Hazardous substances may leak into the ground water and enter the food chain.



12 Installation instructions

12.1 F-Gas instruction

This product contains fluorinated greenhouse gases.

The fluorinated greenhouse gases are contained in hermetically sealed equipment.

Installs, services, maintains, repairs, checks for leaks or decommissions equipment and product recycling should be carried out by natural persons that hold relevant certificates.

If the system has a leakage detection system installed, leakage checks should be performed at least every 12 months, make sure system operate properly.

If product must be performed leakage checks, it should specify Inspection cycle, establish and save records of leakage checks.



Note: For hermetically sealed equipment, local air conditioner, window air conditioner and dehumidifier, if CO₂ equivalent of fluorinated greenhouse gases is less than 10 tonnes, it should not perform leakage checks.

13 Specifications

BEEPI

Model name	Indoor unit	BEEPI 090	BEEPI 120
	Outdoor unit	BEEPI 091	BEEPI 121
Refrigerant		R32	R32
Total Refrigerant Amount (g)		620	620
GWP		675	675
CO2 equivalent (tonnes)		0.419	0.419
Anti-Electric		Class I	Class I
Climate Class		T1	T1
Heating Type		Heat Pump	Heat Pump
Power Supply Connection		Outdoor	Outdoor
Pdesign C (kW)		2.5	3.2
Pdesign H (kW)		2.4 (EU Average Season)	2.4 (EU Average Season)
SEER/AEER/Weight EER (W/W)		9.0 (SEER, EU)	8.5 (SEER, EU)
SCOP/ACOP/Weight EER (W/W)		4.6(SCOP, EU Average)	4.6(SCOP, EU Average)
Energy Level-Cooling		A+++ (EU)	A+++ (EU)
Energy Level-Heating		A++ (EU Average Season)	A++ (EU Average Season)
Annual Energy Consumption-Cooling (kWh)		98	132
Annual Energy Consumption-Heating (kWh)		743	743
The declared capacity for calculation of SCOP at reference design condition (kW)		2.1	2.1
The back up heating capacity assumed for calculation of SCOP at reference design condition (kW)		0.3	0.3
Power of Electric Heater (W)		/	/
Cooling Power Input (W)		/	/
Heating Power Input (W)		/	/
Voltage/Frequency (V/Hz)		220-240V~ 50Hz, 1Ph	220-240V~ 50Hz, 1Ph
Cooling Running Current (A)		/	/
Heating Running Current (A)		/	/
Noise Pressure Level - Indoor Unit (dBA)		37/33/23/20	39/35/24/21
Noise Pressure Level - Outdoor Unit (dBA)		54.0	54.5
Air flow volume (m3/h)		483/362/303	584/477/395
Rated Power Input-EN 60335(W)		2200	2200
Rated Current Input-EN 60335(A)		10.5	10.5
Indoor unit Resistance Class		IPX0	IPX0

13 Specifications

Model name	Indoor unit	BEEPI 090	BEEPI 120
	Outdoor unit	BEEPI 091	BEEPI 121
Outdoor unit Resistance Class		IP24	IP24
High Pressure Pipe Diameter (mm)		Φ6.35(1/4")	Φ6.35(1/4")
Low Pressuer Pipe Diameter (mm)		Φ9.52(3/8")	Φ9.52(3/8")
Power Supply Cord specification (mm ²)		3G2.5	3G2.5
Indoor & Outdoor Connection Cord (mm ²)		5G1.5	5G1.5
Max. elevation (m)		10	10
Max. pipe length (m)		25	25
Additional Gas Quantity (g/m)		12	12
Indoor Unit (WxHxD) mm		832×297×223	832×297×223
Outdoor Unit (WxHxD) mm		765×555×303	765×555×303
Indoor Unit Net Weight (kg)		9.5	9.5
Outdoor Unit Net Weight (kg)		27.0	27.0

Note:

1. Specifications are standard values calculated based on rated operating conditions, They will vary in difference work condition.
2. Our company has quick technical imporvments. There will be prior notice for any change of technical data. Please read nameplate on the air-conditioner.

Please refer to detail product information required in Regulation No 206/2012 from leaflet of Product Fiche.

13 Specifications

BEHPI

Model name	Indoor unit	BEHPI 090	BEHPI 120	BEHPI 180	BEHPI 240
	Outdoor unit	BEHPI 091	BEHPI 121	BEHPI 181	BEHPI 241
Refrigerant		R32	R32	R32	R32
Total Refrigerant Amount (g)		550	550	1100	1450
GWP		675	675	675	675
CO2 equivalent (tonnes)		0.371	0.371	0.743	0.979
Anti-Electric		Class I	Class I	Class I	Class I
Climate Class		T1	T1	T1	T1
Heating Type		Heat Pump	Heat Pump	Heat Pump	Heat Pump
Power Supply Connection		Outdoor	Outdoor	Outdoor	Outdoor
Pdesign C (kW)		2.7	3.5	5.2	7.0
Pdesign H (kW)		2.7 (EU Average Season)	2.9 (EU Average Season)	4.1 (EU Average Season)	4.9 (EU Average Season)
SEER/AEER/Weight EER (W/W)		6.9(SEER, EU)	7.0(SEER, EU)	7.0(SEER, EU)	6.5(SEER, EU)
SCOP/ACOP/Weight EER (W/W)		4.0(SCOP, EU Average)	4.0(SCOP, EU Average)	4.0(SCOP, EU Average)	4.0(SCOP, EU Average)
Energy Level-Cooling		A++ (EU)	A++ (EU)	A++ (EU)	A++ (EU)
Energy Level-Heating		A+ (EU Average Season)	A+ (EU Average Season)	A+ (EU Average Season)	A+ (EU Average Season)
Annual Energy Consumption-Cooling (kWh)		137	175	260	377
Annual Energy Consumption-Heating (kWh)		945	990	1435	1730
The declared capacity for calculation of SCOP at reference design condition (kW)		2.6	2.7	3.4	3.7
The back up heating capacity assumed for calculation of SCOP at reference design condition (kW)		0.1	0.2	0.7	1.2
Power of Electric Heater (W)		/	/	/	/
Cooling Power Input (W)		/	/	/	/
Heating Power Input (W)		/	/	/	/
Voltage/Frequency (V/Hz)		220-240V~ 50Hz, 1Ph	220-240V~ 50Hz, 1Ph	220-240V~ 50Hz, 1Ph	220-240V~ 50Hz, 1Ph
Cooling Running Current (A)		/	/	/	/
Heating Running Current (A)		/	/	/	/
Noise Pressure Level - Indoor Unit (dBA)		56	55	57	63
Noise Pressure Level - Outdoor Unit (dBA)		63	63	65	67

13 Specifications

Model name	Indoor unit	BEHPI 090	BEHPI 120	BEHPI 180	BEHPI 240
	Outdoor unit	BEHPI 091	BEHPI 121	BEHPI 181	BEHPI 241
Air flow volume (m ³ /h)		416/309/230	584/477/395	730/500/420	1020/830/640
Rated Power Input-EN 60335(W)		2150	2150	2500	3700
Rated Current Input-EN 60335(A)		10	10	13	19
Indoor unit Resistance Class		IPX0	IPX0	IPX0	IPX0
Outdoor unit Resistance Class		IP24	IP24	IP24	IP24
High Pressure Pipe Diameter (mm)		6.35mm(1/4in)	6.35mm(1/4in)	6.35mm(1/4in)	9.52mm(3/8in)
Low Pressure Pipe Diameter (mm)		9.52mm(3/8in)	9.52mm(3/8in)	12.7mm(1/2in)	15.9mm(5/8in)
Power Supply Cord specification (mm ²)		1.5x3	1.5x3	1.5x3	2.5x3
Indoor & Outdoor Connection Cord (mm ²)		1.5x5	1.5x5	1.5x5	2.5x5
Max. elevation (m)		10	10	20	25
Max. pipe length (m)		25	25	30	50
Additional Gas Quantity (g/m)		12	12	12	24
Indoor Unit (WxHxD) mm		752×290×219	832×297×223	995×319×251	1119×336×259
Outdoor Unit (WxHxD) mm		720x495x270	720x495x270	805x554x330	890x673x342
Indoor Unit Net Weight (kg)		8.5	9.5	12	15
Outdoor Unit Net Weight (kg)		23	23	32	43

Note:

1. Specifications are standard values calculated based on rated operating conditions, They will vary in difference work condition.
2. Our company has quick technical improvements. There will be prior notice for any change of technical data. Please read nameplate on the air-conditioner.

Please refer to detail product information required in Regulation No 206/2012 from leaflet of Product Fiche.

13 Specifications

BEVPI

Model name	Indoor unit	BEVPI 090	BEVPI 120	BEVPI 180	BEVPI 240
	Outdoor unit	BEVPI 091	BEVPI 121	BEVPI 181	BEVPI 241
Refrigerant		R32	R32	R32	R32
Total Refrigerant Amount (g)		550	550	1100	1450
GWP		675	675	675	675
CO2 equivalent (tonnes)		0.371	0.371	0.743	0.979
Anti-Electric		Class I	Class I	Class I	Class I
Climate Class		T1	T1	T1	T1
Heating Type		Heat Pump	Heat Pump	Heat Pump	Heat Pump
Power Supply Connection		Outdoor	Outdoor	Outdoor	Outdoor
Pdesign C (kW)		2.7	3.5	5.2	7.0
Pdesign H (kW)		2.7 (EU Average Season)	2.9 (EU Average Season)	4.1 (EU Average Season)	4.9 (EU Average Season)
SEER/AEER/Weight EER (W/W)		6.9(SEER, EU)	7.0(SEER, EU)	7.0(SEER, EU)	6.5(SEER, EU)
SCOP/ACOP/Weight EER (W/W)		4.0(SCOP, EU Average)	4.0(SCOP, EU Average)	4.0(SCOP, EU Average)	4.0(SCOP, EU Average)
Energy Level-Cooling		A++ (EU)	A++ (EU)	A++ (EU)	A++ (EU)
Energy Level-Heating		A+ (EU Average Season)	A+ (EU Average Season)	A+ (EU Average Season)	A+ (EU Average Season)
Annual Energy Consumption-Cooling (kWh)		137	175	260	377
Annual Energy Consumption-Heating (kWh)		945	990	1435	1730
The declared capacity for calculation of SCOP at reference design condition (kW)		2.6	2.7	3.4	3.7
The back up heating capacity assumed for calculation of SCOP at reference design condition (kW)		0.1	0.2	0.7	1.2
Power of Electric Heater (W)		/	/	/	/
Cooling Power Input (W)		/	/	/	/
Heating Power Input (W)		/	/	/	/
Voltage/Frequency (V/Hz)		220-240V~ 50Hz, 1Ph	220-240V~ 50Hz, 1Ph	220-240V~ 50Hz, 1Ph	220-240V~ 50Hz, 1Ph
Cooling Running Current (A)		/	/	/	/
Heating Running Current (A)		/	/	/	/
Noise Pressure Level - Indoor Unit (dBA)		56	55	57	63
Noise Pressure Level - Outdoor Unit (dBA)		63	63	65	67

13 Specifications

Model name	Indoor unit	BEVPI 090	BEVPI 120	BEVPI 180	BEVPI 240
	Outdoor unit	BEVPI 091	BEVPI 121	BEVPI 181	BEVPI 241
Air flow volume (m ³ /h)		416/309/230	584/477/395	730/500/420	1020/830/640
Rated Power Input-EN 60335(W)		2150	2150	2500	3700
Rated Current Input-EN 60335(A)		10	10	13	19
Indoor unit Resistance Class		IPX0	IPX0	IPX0	IPX0
Outdoor unit Resistance Class		IP24	IP24	IP24	IP24
High Pressure Pipe Diameter (mm)		6.35mm(1/4in)	6.35mm(1/4in)	6.35mm(1/4in)	9.52mm(3/8in)
Low Pressure Pipe Diameter (mm)		9.52mm(3/8in)	9.52mm(3/8in)	12.7mm(1/2in)	15.9mm(5/8in)
Power Supply Cord specification (mm ²)		1.5x3	1.5x3	1.5x3	2.5x3
Indoor & Outdoor Connection Cord (mm ²)		1.5x5	1.5x5	1.5x5	2.5x5
Max. elevation (m)		10	10	20	25
Max. pipe length (m)		25	25	30	50
Additional Gas Quantity (g/m)		12	12	12	24
Indoor Unit (WxHxD) mm		752×290×219	832×297×223	995×319×251	1119×336×259
Outdoor Unit (WxHxD) mm		720x495x270	720x495x270	805x554x330	890x673x342
Indoor Unit Net Weight (kg)		8.5	9.5	12	15
Outdoor Unit Net Weight (kg)		23	23	32	43

Note:

1. Specifications are standard values calculated based on rated operating conditions, They will vary in difference work condition.
2. Our company has quick technical improvements. There will be prior notice for any change of technical data. Please read nameplate on the air-conditioner.

Please refer to detail product information required in Regulation No 206/2012 from leaflet of Product Fiche.

Najprije pročitajte ovaj korisnički priručnik!

Dragi kupče,

hvala što ste odabrali proizvod marke Beko. Nadamo se da ćete od vašeg proizvoda koji je proizveden uz primjenu visokokvalitetne i najsuvremenije tehnologije dobiti najbolje rezultate. Stoga vas molimo da pažljivo pročitate korisnički priručnik u cijelosti, kao i sve druge popratne dokumente, prije upotrebe proizvoda te ga zadržite za buduću uporabu. Ako proizvod date nekome drugome, toj osobi dajte i korisnički priručnik. Pratite sva upozorenja i informacije iz korisničkog priručnika.

Značenje simbola

Sljedeći se simboli koriste u raznim odjeljcima ovog priručnika:

	Važne informacije ili korisne natuknice o uporabi.
--	--

	Upozorenje na situacije opasne po ljudski život i imovinu.
--	--

	Upozorenje o radnjama koje nikada ne smijete izvoditi.
--	--

	Upozorenje o mogućnosti strujnog udara.
--	---

	Simbol ukazuje na to da su informacije dostupne, kao npr. u priručniku za uporabu ili priručniku za ugradnju.
---	---

	Ne pokrivati.
--	---------------

	Simbol ukazuje na to da bi se priručnik za uporabu trebao pažljivo pročitati.
---	---

	Simbol ukazuje na to da bi servisno osoblje trebalo rukovati opremom uz praćenje uputa iz priručnika za ugradnju.
---	---

 (Za vrstu plina R32/R290)	Simbol ukazuje na to da se u uređaju koristi zapaljivo rashladno sredstvo. Ako rashladno sredstvo iscuri i izloži se vanjskom izvoru paljenja, postoji opasnost od nastanka požara.
---	---



RECIKLIRANI I
RECIKLAŽNI PAPIR

SADRŽAJ

1 Sigurnosne mjere predostrožnosti	61	8 Probni rad	100
2 Pregled	69	8.1 Upute za probni rad.....	100
2.1 Dijelovi jedinice.....	70	9 Njega i održavanje	102
2.2 Upravljački elementi i dijelovi.....	71	9.1 Čišćenje unutarnje jedinice.....	102
3 Specifikacije i značajke uređaja	72	9.2 Čišćenje filtra za zrak.....	102
3.1 Zaslon unutarnje jedinice.....	72	9.3 Održavanje – duga razdoblja nekorištenja.....	104
3.2 Radna temperatura.....	73	9.4 Održavanje – Provjera prije sezone.....	104
3.3 Tip Split sustav s inverterom.....	74	10 Otklanjanje poteškoća	105
3.4 Tip uređaja s fiksnom brzinom.....	74	10.1 Uobičajeni problemi.....	105
3.5 Ostale značajke.....	75	10.2 Otklanjanje poteškoća.....	107
3.6 Postavljanje kuta protoka zraka.....	76	11 Europske smjernice za odlaganje	110
3.6.1 Postavljanje okomitog kuta protoka zraka.....	76	12 Upute za ugradnju	111
3.6.2 Postavljanje vodoravnog kuta strujanja zraka.....	76	12.1 Upute za F-plin.....	111
3.7 Ugradite komplet HomeWhiz (bežični modul).....	76	13 Specifikacije	112
3.8 Ručni rad (bez daljinskog upravljača).....	77		
4 Ugradnja	78		
4.1 Sažetak postupka ugradnje – unutarnja jedinica.....	78		
4.2 Upute za ugradnju – unutarnja jedinica.....	79		
4.2.1 Prije ugradnje.....	79		
4.2.2 Dimenzije noseće ploče.....	80		
4.2.3 Prije izvođenja bilo kakvih električnih radova, pročitajte ove propise.....	82		
4.3 Ugradnja vanjske jedinice.....	86		
4.3.1 Upute za ugradnju – Vanjska jedinica.....	86		
5 Spajanje cjevovoda za rashladno sredstvo	92		
5.1 Upute za spajanje – cjevovod rashladnog sredstva.....	93		
5.2 Upute za spajanje cjevovoda s unutarnjom jedinicom.....	94		
5.3 Upute za spajanje cjevovoda s vanjskom jedinicom.....	95		
6 Uklanjanje zraka	96		
6.1 Pripremne radnje i mjere opreza.....	96		
6.1.1 Prije izvođenja evakuacije.....	96		
6.1.2 Upute za evakuaciju.....	96		
6.1.3 Napomena o dodavanju rashladnog sredstva.....	97		
7 Električne provjere i provjere curenja plina	99		
7.1 Prije probnog rada.....	99		
7.2 Provjere vezane uz električnu sigurnost.....	99		
7.3 Provjere curenja plina.....	99		

1 Sigurnosne mjere predostrožnosti

Upozorenje

Ovaj uređaj mogu koristiti djeca starosne dobi od 8 godina i starija i osobe ograničenih tjelesnih, osjetilnih ili mentalnih sposobnosti ili nedostatnog iskustva i znanja ako su pod nadzorom ili ako su upućeni u način sigurnog korištenja uređaja te ako su razumjeli opasnosti koje mogu nastati iz toga. Djeca se ne smiju igrati uređajem. Djeca ne smiju provoditi čišćenje i održavanje uređaja bez nadzora (zemlje Europske Unije).

Uređaj nije namijenjen za upotrebu osobama (uključujući djecu) sa smanjenim fizičkim, senzornim ili mentalnim sposobnostima ili nedostatkom iskustva i znanja, osim u slučaju dobivenih uputa u vezi korištenja uređaja i nadzora odgovorne osobe. Djeca trebaju biti pod nadzorom kako se ne bi igrala s uređajem.

Upozorenja za uporabu proizvoda

- Ako se pojavi nenormalna situacija (kao što je miris paljevine), odmah isključite jedinicu, te isključite napajanje. Pozovite svog prodavača da biste dobili upute o tome kako izbjeći strujni udar, požar ili ozljedu.
- **Nemojte** stavljati prste, šipke ili druge predmete u otvore za ulaz ili izlaz zraka. To može dovesti do ozljede jer se ventilator može okretati pri velikim brzinama.
- **Nemojte** koristiti zapaljive sprejeve kao što je sprej za kosu, lak ili boju u blizini uređaja. To može prouzročiti požar ili izgaranje.
- **Nemojte** koristiti klima uređaj na mjestima u blizini ili oko zapaljivih plinova. Ispušteni se plin može nakupiti oko uređaja i prouzročiti eksploziju.
- **Nemojte** koristiti klima uređaj u prostorijama s puno vlage kao što su kupaonice ili praonice. Pretjerano izlaganje

1 Sigurnosne mjere predostrožnosti

vodi može prouzročiti kratki spoj električnih dijelova.

- **Nemojte** se izravno izlagati hladnom zraku tijekom duljeg razdoblja.
- **Nemojte** dopuštati djeci da se igraju s klima uređajem. Djeca u blizini uređaja moraju biti pod neprestanim nadzorom.
- Ako se klima uređaj koristi zajedno s plamenicima ili drugim uređajima za grijanje, temeljito prozračujte prostoriju da biste izbjegli pomanjkanje kisika.
- U određenim funkcionalnim okruženjima, kao što su kuhinje, prostorije s poslužiteljima i sl., preporučuje se upotreba klima uređaja za posebne namjene.

Upozorenja vezana uz čišćenje i održavanje

- Isključite uređaj i odspojite strujno napajanje prije čišćenja. Ako to ne učinite, može doći do strujnog udara.
- **Nemojte** čistiti klima uređaj prekomjernom količinom vode.

- **Nemojte** čistiti klima uređaj zapaljivim sredstvima za čišćenje. Zapaljiva sredstva za čišćenje mogu prouzročiti požar ili deformaciju.

Opres

- Isključite klima uređaj i odspojite ga iz strujnog napajanja ako ga nećete koristiti dulje vrijeme.
- Isključite uređaj i izvucite utikač iz utičnice za vrijeme oluja.
- Provjerite može li kondenzat nesmetano curiti iz uređaja.
- **Nemojte** rukovati klima uređajem mokrim rukama. To može prouzročiti strujni udar.
- **Nemojte** koristiti uređaj u bilo koju drugu svrhu osim u onu za koju je namijenjen.
- **Nemojte** se penjati na vanjsku jedinicu ili stavljati predmete na istu.
- **Nemojte** paliti klima uređaj na duže vrijeme ako su vrata ili prozori otvoreni, ili ako je u prostoriji velika količina vlage.

1 Sigurnosne mjere predostrožnosti

Upozorenja vezana uz električne instalacije

- Koristite samo propisani kabel za napajanje. Ako se kabel za napajanje uređaja ošteti, mora ga zamijeniti proizvođač, korisnička služba proizvođača ili osoba sličnih kvalifikacija kako bi se izbjegle opasnosti.
- Održavajte utikač čistim. Uklonite bilo kakvu prašinu ili prljavštinu koja se nakupi na ili oko utikača. Prljavi utikači mogu prouzročiti požar ili strujni udar.
- **Nemojte** povlačiti kabel za napajanje da biste izvukli utikač iz utičnice. Čvrsto držite utikač i izvucite ga iz utičnice. Izravno povlačenje kabela može dovesti do oštećenja, a to može dovesti do požara ili strujnog udara.
- **Nemojte** mijenjati dužinu kabela za napajanje ili koristiti produžni kabel za napajanje uređaja.
- **Nemojte** priključiti uređaj na utičnicu u koju su uključeni drugi uređaji. Neprikladno ili nedovoljno napajanje može prouzročiti požar ili strujni udar.
- Proizvod mora biti pravilno uzemljen u trenutku ugradnje, u suprotnom može doći do strujnog udara.
- Kod svih električarskih radova postupajte u skladu s lokalnim i nacionalnim standardima i propisima za postavljanje električnih instalacija, kao i u skladu s priručnikom za ugradnju. Čvrsto spojite kablove i stabilno ih učvrstite da biste spriječili oštećenje rednih stezaljki djelovanjem vanjskih sila. Nepravilni se električni spojevi mogu pregrijati i prouzročiti požar, a također postoji opasnost od strujnog udara. Svi se električni spojevi moraju izvesti u skladu sa shemom električnih spojeva koja se nalazi na pločama unutarnje i vanjske jedinice.
- Sve električne instalacije moraju biti pravilno raspoređene kako bi se osiguralo da se kontrolna ploča može pravilno zatvoriti.

1 Sigurnosne mjere predostrožnosti

Ako se kontrolna ploča ne zatvori pravilno može doći do korozivnog djelovanja, što može prouzročiti zagrijavanje i zapaljenje spojnih točaka na rednim stezaljkama, što može uzrokovati strujni udar.

- Ako se napajanje spaja na fiksno ožičenje, uređaj za rastavljanje svih polova koji ima najmanje 3 mm razmaka na svim polovima i odvodnu struju koja može premašiti 10 mA, uređaj rezidualne struje (RCD) čija nazivna rezidualna radna struja ne prelazi 30 mA i rastavljanje moraju biti ugrađeni u fiksno ožičenje u skladu s pravilima o ožičenju.

Obraćanje pozornosti na specifikacije osigurača

Tiskana pločica (PCB) klima uređaja izvedena je s osiguračem kako bi se osigurala prenaponska zaštita. Specifikacije osigurača otiskane su na tiskanoj pločici, kao što su:

T3.15AL/250VAC, T5AL/250VAC, T3.15A/250VAC, T5A/250VAC, T20A/250VAC, T30A/250VAC, itd.



Napomena: Kod uređaja koji upotrebljavaju rashladno sredstvo R32 ili R290, može se koristiti samo keramički osigurač otporan na eksploziju.

Upozorenja za ugradnju proizvoda

1. Ugradnju mora obaviti ovlaštenu prodavač ili stručnjak. Zbog neispravne ugradnje može doći do curenja vode, strujnog udara ili požara.
2. Ugradnja se mora izvršiti prema uputama za ugradnju. Zbog neprimjerene ugradnje može doći do curenja vode, strujnog udara ili požara.
3. Kontaktirajte ovlaštenog servisnog tehničara za potrebe popravka ili održavanja ovog uređaja. Uređaj se mora ugraditi

1 Sigurnosne mjere predostrožnosti

- u skladu s nacionalnim tehničkim propisima za električne instalacije.
4. Za ugradnju koristite samo priloženi pribor, dijelove i propisane dijelove. Korištenje dijelova koji nisu standardni može prouzročiti curenje vode, strujni udar, požar i neispravnost uređaja.
 5. Ugradite uređaj na stabilno mjesto koje može podržati masu jedinice. Ako odabrano mjesto ne može podržati masu jedinice ili ako se ugradnja ne obavi pravilno, jedinica može pasti i prouzročiti ozbiljnu štetu ili ozljedu.
 6. Ugradite cjevovod za odvodnju prema uputama iz ovog priručnika. Nepravilna odvodnja može dovesti do oštećenja vašeg doma i imovine uzrokovanog vodom.
 7. Uređaje koji imaju pomoćnu električnu grijalicu **nemojte** ugrađivati na udaljenosti manjoj od 1 metra (3 stope) od zapaljivih materijala.
 8. **Nemojte** ugrađivati uređaj na mjesto gdje postoji mogućnost od curenja zapaljivih plinova. Ako se zapaljivi plin nakupi oko uređaja, može doći do požara.
 9. Nemojte uključivati napajanje dok ne završe svi radovi.
 10. Kada pomičete ili premješate klima uređaj, za odspajanje i ponovnu ugradnju jedinice konzultirajte iskusne servisne tehničare.
 11. Pojediniosti o načinu ugradnje uređaja na postolje pročitajte u odjeljcima „ugradnja unutarnje jedinice“ i „ugradnja vanjske jedinice“.

Napomena o fluoriranim plinovima (Nije primjenjivo na jedinicu koja koristi rashladno sredstvo R290)

1. Ovaj klima uređaj sadrži fluorirane stakleničke plinove. Za specifične informacije o vrsti plina i njegovoj količini, pogledajte odgovarajuću naljepnicu na jedinici ili „Korisnički priručnik – Informacijski list proizvođača“

1 Sigurnosne mjere predostrožnosti

na ambalaži vanjske jedinice. (Samo proizvodi Europske unije).

2. Ugradnju, servis, održavanje i popravak ovog uređaja mora obavljati certificirani tehničar.
3. Uklanjanje i recikliranje proizvoda mora obaviti certificirani tehničar.
4. Za opremu koja sadrži fluorirane stakleničke plinove u količinama od 5 tona ekvivalenta CO₂ ili više, no manje od 50 tona ekvivalenta CO₂, ako sustav ima ugrađen sustav za detekciju curenja, isti se mora provjeravati na curenje najmanje svaka 24 mjeseca.
5. Kada se provjerava curi li uređaj, preporučuje se vođenje evidencije svih provjera.

Upozorenje vezano za uporabu rashladnog sredstva R32/R290

- Kada se koristi zapaljivo rashladno sredstvo, uređaj se mora skladištiti u dobro

ventiliranom prostoru gdje veličina prostorije odgovara onoj navedenoj za rad.

Za modele s rashladnim sredstvom R32:

Uređaj se mora postaviti, koristiti i skladištiti u prostoriji površine veće od 4 m².

Za modele s rashladnim sredstvom R290, uređaj se mora ugraditi, raditi i skladištiti u prostoriji s površinom poda koja je veća od:

<=9000 Btu/h jedinica: 13 m²

>9000 Btu/h i <=12000 Btu/h jedinica: 17 m²

>12000 Btu/h i

<=18000 Btu/h jedinica: 26 m²

>18000 Btu/h i

<=24000 Btu/h jedinica: 35 m²

- Mehanički konektori za višekratnu upotrebu i zglobovi plamenika zabranjeni su za uporabu u zatvorenim prostorima. (EN standardni zahtjevi).
- Mehanički konektori koji se

1 Sigurnosne mjere predostrožnosti

upotrebljavaju u zatvorenim prostorima imaju stopu ne višu od 3g/godinu pri 25 % maksimalnog dozvoljenog tlaka. Kod ponovne upotrebe mehaničkih konektora u zatvorenim prostorima, moraju se obnoviti brtveni dijelovi. Kad se prošireni dijelovi ponovo koriste u zatvorenom prostoru, prošireni se dio mora ponovo proizvesti. (UL standardni zahtjevi)

- Kod ponovne upotrebe mehaničkih konektora u zatvorenim prostorima, moraju se obnoviti brtveni dijelovi. Kad se prošireni dijelovi ponovo koriste u zatvorenom prostoru, prošireni se dio mora ponovo proizvesti. (IEC standardni zahtjevi)
- Mehanički konektori koji se koriste u zatvorenom prostoru moraju biti u skladu sa standardom ISO 14903.

Europske smjernice za

odlaganje

Ova oznaka prikazana na proizvodu i pripadajućoj dokumentaciji pokazuje da se električni otpad i električna oprema ne smiju miješati s miješanim kućnim otpadom.



Ispravno odlaganje ovog proizvoda (Električni otpad & Elektronska oprema)

Ovaj uređaj sadrži rashladno sredstvo i druge materijale koji mogu biti opasni. Prilikom odlaganja ovog uređaja, zakonom su određeni posebni postupci prikupljanja i obrade. Nemojte odlagati ovaj proizvod kao otpad iz kućanstva ili nerazvrstani komunalni otpad. Prilikom odlaganja ovog uređaja, imate sljedeće mogućnosti:

- odlaganje uređaja u određenom objektu za prikupljanje komunalnog elektroničkog otpada.
- prilikom kupovine novog

1 Sigurnosne mjere predostrožnosti

uređaja, prodavač će preuzeti stari uređaj bez dodatne naknade.











- proizvođač će preuzeti stari uređaj bez dodatne naknade. (za neke zemlje)
- prodajte uređaj ovlaštenom trgovcu za otpadni metal. (za neke zemlje)



Posebna napomena:
Odlaganje uređaja u šumi ili drugom prirodnom okruženju ugrožava vaše zdravlje i loše je za okoliš. Opasne tvari mogu iscuriti u podzemnu vodu i ući u prehrambeni lanac.

2 Pregled

Klima uređaj isporučuje se uz sljedeći pribor. Za ugradnju klima uređaja iskoristite sve dijelove i sav pribor za ugradnju. Nepravilna ugradnja može dovesti do curenja vode, strujnog udara i požara ili može prouzročiti kvar uređaja. Stavke koje nisu uključene u klima uređaj moraju se kupiti zasebno.

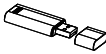
Naziv pribora	Količina (kom)	Oblik	Naziv pribora	Količina (kom)	Oblik
Priručnik	2-3		Daljinski upravljač	1	
Odvodni spoj (za modele za hlađenje i grijanje)	1		Baterija	2	
Brtva (za modele za hlađenje i grijanje)	1		Držac daljinskog upravljača (nije obavezno)	1	
Noseća ploča	1		Pričvrtni vijak za držač daljinskog upravljača (nije obavezno)	2	
Zatezač	5~8 (ovisno o modelu)		Mali filter (treba ga ugraditi ovlašteni tehničar sa stražnje strane glavnog filtra za zrak prilikom ugradnje stroja)	1~2 (ovisno o modelu)	
Pričvrtni vijak za noseću ploču	5~8 (ovisno o modelu)				
Bežični USB komplet	1 (samo za Wifi modele)				

2 Pregled

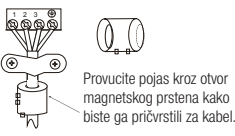
Naziv	Oblik		Količina (kom)
Spajanje cijevnog pribora	Strana s tekućinom	Φ 6,35 (1/4 inča) Φ 9,52 (3/8 inča)	Dijelove morate kupiti zasebno. Za ispravnu veličinu cijevi jedinice koju ste kupili obratite se trgovcu.
	Strana s plinom	Φ 9,52 (3/8 inča) Φ 12,7 (1/2 inča) Φ 16 (5/8 inča) Φ 19 (3/4 inča)	
Magnetski prsten i remen (ako su isporučeni, pogledajte dijagram ožičenja kako biste ih ugradili na priključni kabel)			Razlikuje se ovisno o modelu

2.1 Dijelovi jedinice



Ugradnju treba izvesti u skladu sa zahtjevima lokalnih i nacionalnih standarda. Ugradnja se može malo razlikovati u različitim područjima.

2 Pregled

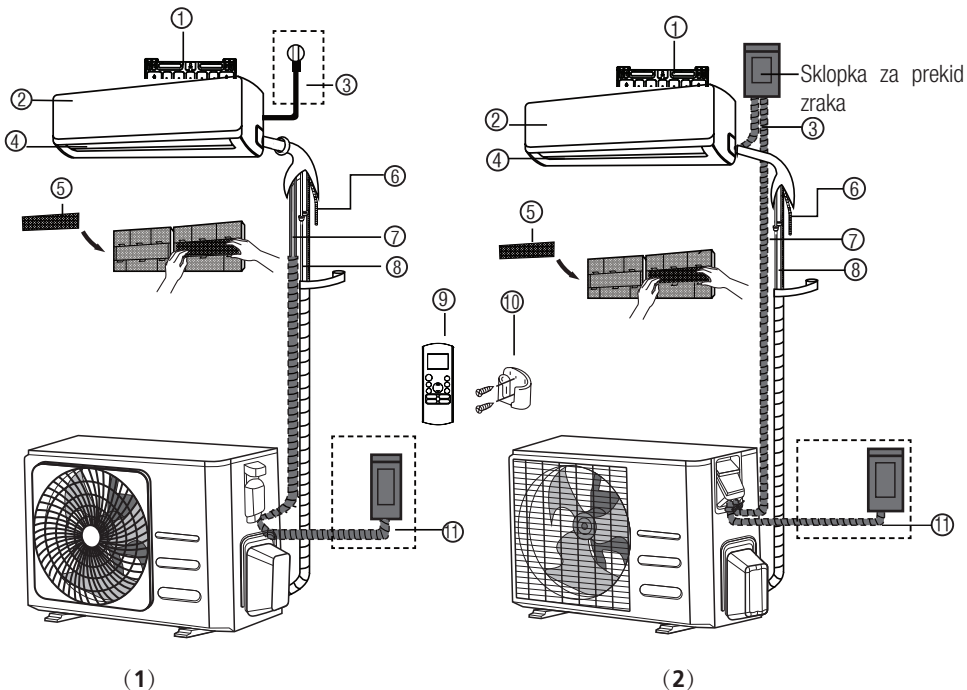

2.2 Upravljački elementi i dijelovi

1. Zidna noseća ploča
2. Prednja ploča
3. Kabel za napajanje (na nekim uređajima)
4. Otvor za zrak
5. Funkcionalni filtar (na stražnjoj strani glavnog filtra – neke jedinice)
6. Cijev za odvod
7. Signalni kabel
8. Cjevovod za rashladno sredstvo
9. Daljinski upravljač
10. Držač daljinskog upravljača (neke jedinice)
11. Kabel za napajanje vanjske jedinice (na nekim uređajima)

Slike u ovom priručniku služe isključivo za potrebe objašnjenja. Stvarni izgled vaše unutarnje jedinice može biti malo drugačiji. Postupajte u skladu sa stvarnim izgledom vašeg modela.

3 Specifikacije i značajke uređaja

3.1 Zaslون unutarnje jedinice



Različiti modeli imaju različitu prednju ploču i prozorčić za prikaz. Svi dolje opisani indikatori nisu dostupni za klima uređaj koji ste kupili. Provjerite prozorčić za prikaz na unutarnjoj jedinici koju ste kupili.



Slike u ovom priručniku služe isključivo za potrebe objašnjenja. Stvarni izgled vaše unutarnje jedinice može biti malo drugačiji. Postupajte u skladu sa stvarnim izgledom vašeg modela.

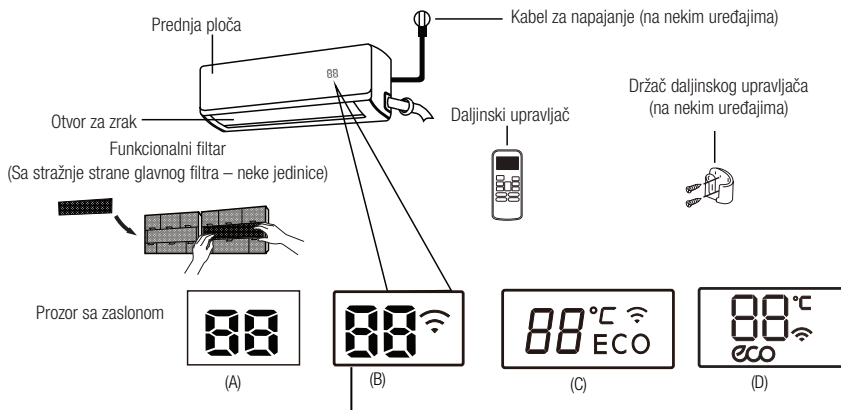

" **ECO** " Kad je aktivirana funkcija ECO (ekološki) (neke jedinice)

" **°C** " Svijetli različitim bojama ovisno o načinu rada (neke jedinice).
U načinu rada COOL (Hlađenje) i DRY (Odvlaživanje), prikazuje se kao hladna boja.
U načinu rada HEAT (Grijanje), prikazuje se kao topla boja.

" **Wi-Fi** " kada je aktivirana značajka za bežično upravljanje (na nekim uređajima)

" **88** " Prikazuje temperaturu, funkciju rada i kodove grešaka:

" **01** " u trajanju od 3 sekunde kada:

- Je postavljen TIMER ON (BROJAČ VREMENA DO UKLJUČIVANJA) (jedinica je ISKLJUČENA, " **01** " ostaje na postavci TIMER ON (BROJAČ VREMENA DO UKLJUČIVANJA))
- Značajka FRESH (SVJEŽE), SWING (ZAMAH), TURBO (UBRZANI RAD), SILENCE (TIŠINA) ili SOLAR PV ECO je uključena " **0F** " na 3 sekunde kada:
- Je postavljen TIMER OFF (BROJAČ VREMENA DO ISKLJUČENJA)
- Značajka FRESH (SVJEŽE), SWING (ZAMAH), TURBO (UBRZANI RAD), SILENCE (TIŠINA) ili SOLAR PV ECO je isključena

" **cF** " kada je uključena značajka za sprječavanje izlaza hladnog zraka

" **df** " kod je uključeno odmrzavanje (jedinice za hlađenje i grijanje)

" **Sc** " kada je uključeno samočišćenje

" **FP** " kada je uključena značajka 8 °C grijanje

Značenja
prikazanog koda

3 Specifikacije i značajke uređaja

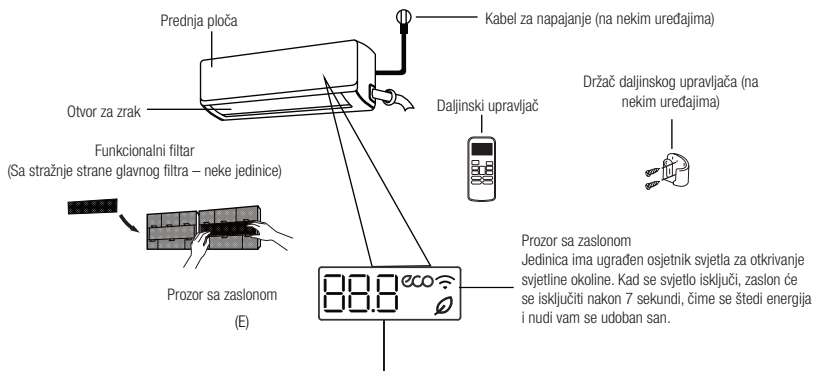

88.8 Prikazuje temperaturu, radnu značajku i kodove grešaka::

ON u trajanju od 3 sekunde kada:

- Je postavljen TIMER ON (BROJAČ VREMENA DO UKLJUČIVANJA) (jedinica je ISKLJUČENA, "ON" ostaje na postavci TIMER ON (BROJAČ VREMENA DO UKLJUČIVANJA))

- Značajke FRESH (SVJEŽE), SWING (ZAMAH), TURBO (UBRZANI RAD), ili SILENCE (TIŠINA) su uključene

OF u trajanju od 3 sekunde kada:

- Je postavljen TIMER OFF (BROJAČ VREMENA DO ISKLJUČENJA)

- Značajke FRESH (SVJEŽE), SWING (ZAMAH), TURBO (UBRZANI RAD), ili SILENCE (TIŠINA) su isključene

DF kad je uključeno odmrzavanje (za jedinice za hlađenje i grijanje)

SC kad je uključeno samočišćenje (neke jedinice)

FP kada je uključen način grijanja 8°C (46°F) ili 12°C (54°F) (neke jedinice)

∅ kad je uključena značajka osvježavanja (neke jedinice)

ECO kad je aktivirana značajka ECO (Ekološki) (neke jedinice)

Wi-Fi kada je aktivirana značajka za bežično upravljanje (na nekim uređajima)

Značenja prikazanog koda

U načinu rada Fan (Ventilator), uređaj će prikazivati sobnu temperaturu.

U drugim načinima rada, uređaj će pokazivati vašu postavljenu temperaturu.

Pritisnite gumb LED na daljinskom upravljaču i uključit će se prikazni zaslon, ponovo pritisnite gumb LED na 15 sekundi i prikazat će se temperatura u prostoriji, ako ponovo pritisnete nakon 15 sekundi, uključit će se prikazni zaslon.

3.2 Radna temperatura

Kad se vaš klima uređaj upotrebljava izvan raspona sljedećih temperatura, mogu se aktivirati određene sigurnosne zaštitne značajke i uzrokovati deaktiviranje jedinice.

3 Specifikacije i značajke uređaja

3.3 Tip Split sustav s inverterom

Način rada COOL (HLAĐENJE)		Način rada HEAT (GRIJANJE)	Način rada DRY (ODVLAŽIVANJE)
Sobna temperatura	17°C – 32°C (62°F – 90°F)	0°C – 30°C (32°F – 86°F)	10°C – 32°C (50°F – 90°F)
Vanjska temperatura	0°C – 50°C (32°F – 122°F)	-15°C – 30°C (5°F – 86°F)	0°C – 50°C (32°F – 122°F)
	-15°C – 50°C (5°F – 122°F) (Za modele s niskotemperaturnim rashladnim sustavima)		
	0°C – 52°C (32°F – 126°F) (Za posebne tropske modele)		0°C – 52°C (32°F – 126°F) (Za posebne tropske modele)



Za vanjske jedinice s pomoćnim električnim grijačem. Kada je vanjska temperatura ispod 0 °C (32 °F), preporučujemo da uređaj ostavite uključenim u struju cijelo vrijeme kako biste osigurali neometan rad.

3.4 Tip uređaja s fiksnom brzinom

Način rada COOL (HLAĐENJE)		Način rada HEAT (GRIJANJE)	Način rada DRY (ODVLAŽIVANJE)
Sobna temperatura	17°C – 32°C (62°F – 90°F)	0°C – 30°C (32°F – 86°F)	10°C – 32°C (50°F – 90°F)
Vanjska temperatura	18°C – 43°C (64°F – 109°F)	-7°C – 24°C (19°F – 75°F)	11°C – 43°C (52°F – 109°F)
	-7°C – 43°C (19°F – 109°F) (Za modele s niskotemperaturnim rashladnim sustavima)		18°C – 43°C (64°F – 109°F)
	18°C – 52°C (64°F – 126°F) (Za posebne tropske modele)		18°C – 52°C (64°F – 126°F) (Za posebne tropske modele)

3 Specifikacije i značajke uređaja



Relativna vlažnost prostorije manja od 80 %. Ako klima uređaj radi na vrijednosti većoj od ove, na njegovoj površini može doći do stvaranja kondenzacije. Okomite lamele za protok zraka postavite pod maksimalnim kutom (okomito na pod), te postavite način rada ventilatora HIGH (BRZO).

Za daljnju optimizaciju učinkovitosti vašeg uređaja, učinite sljedeće:

- Držite vrata i prozore zatvorenima.
- Ograničite potrošnju energije pomoću funkcija TIMER ON (BROJAČ VREMENA DO UKLJUČIVANJA) i TIMER OFF (BROJAČ VREMENA DO ISKLJUČIVANJA).
- Nemojte blokirati otvore za ulaz ili izlaz zraka.
- Redovno pregledavajte i čistite filtre za zrak.

Vodič za korištenje infracrvenog daljinskog upravljača nije uključen u ovaj paket. Za klima uređaj nisu dostupne sve funkcije, provjerite unutarnji zaslon i daljinski upravljač jedinice koju ste kupili.

3.5 Ostale značajke

• Automatsko ponovno pokretanje (neke jedinice)

Ako uređaj ostane bez napajanja, automatski će se ponovno pokrenuti s prethodno postavljenim postavkama nakon što se ponovno uspostavi napajanje.

• Zaštita od plijesni (na nekim uređajima)

Kada se uređaj isključi iz načina rada COOL (HLAĐENJE), AUTO - COOL (AUTOMATSKI - HLAĐENJE) ili DRY (ODVLAŽIVANJE), klima uređaj će, uz vrlo nisku potrošnju energije, nastaviti raditi

kako bi osušio kondenzat i spriječio nastanak plijesni.

• Bežično upravljanje (na nekim uređajima)

Bežično upravljanje omogućuje vam da upravljate klima uređajem pomoću mobilnog telefona i bežične veze.

Za pristup USB uređaju, zamjenu, radnje održavanja mora izvoditi isključivo profesionalno osoblje.

• Pamćenje kuta lamela za usmjeravanje zraka (na nekim uređajima)

Kada uključite uređaj, lamele za usmjeravanje zraka automatski će se vratiti u prijašnji kut.

• Otkrivanje curenja rashladnog sredstva (na nekim jedinicama)

Unutarnja će jedinica automatski prikazati "EC" ili "ELOC" ili će bljeskati LED svjetla (neke jedinice) kad otkrije curenje rashladnog sredstva.

• Rad s funkcijom Sleep (Spavanje)

Funkcija SLEEP (Spavanje) služi za smanjivanje potrošnje energije dok spavate (pa nije potrebna ista odabrana temperatura da bi se osjećali ugodno). Ta se funkcija može aktivirati samo pomoću daljinskog upravljača. Funkcija Sleep (Spavanje) nije dostupna u načinu rada FAN (Ventilator) ili Dry (Odvlaživanje).

Pritisnite gumb SLEEP (Spavanje) kad ste spremni za spavanje. Ako je odabrani način rada COOL (HLAĐENJE), uređaj će povećati temperaturu za 1 °C (2 °F) nakon 1 sata te će je povećati za dodatnih 1 °C (2 °F) nakon još 1 sata. Ako je odabrani način rada HEAT (GRIJANJE), uređaj će smanjiti temperaturu za 1 °C (2 °F) nakon 1 sata te će je smanjiti za dodatnih 1 °C (2 °F) nakon još 1 sata. Funkcija spavanja zaustavit će se nakon 8 sati i sustav će nastaviti raditi.

3 Specifikacije i značajke uređaja

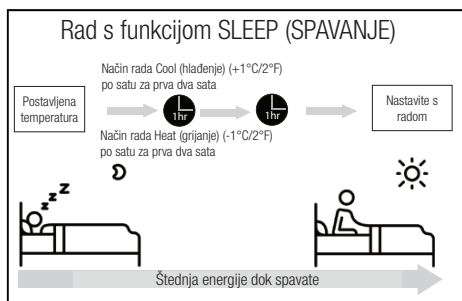

3.6 Postavljanje kuta protoka zraka

3.6.1 Postavljanje okomitog kuta protoka zraka

Dok je jedinica uključena, upotrijebite gumb SWING/DIRECT (ZAMAH/IZRAVNO) na daljinskom upravljaču kako biste postavili smjer (okomiti kut) strujanja zraka. Pojediniosti potražite u Priručniku daljinskog upravljača.



Kada koristite način rada COOL (HLAĐENJE) ili DRY (ODVLAŽIVANJE), nemojte držati lamele u pretjerano okomitom položaju duže vrijeme. To može prouzročiti kondenziranje vode na lamelama, a ona će onda kapati na pod ili namještaj. Kada koristite način rada COOL (HLAĐENJE) ili HEAT (GRIJANJE), postavljanje lamele u pretjerano vodoravan kut može smanjiti učinkovitost uređaja zbog ograničenog strujanja zraka.

3.6.2 Postavljanje vodoravnog kuta strujanja zraka

Vodoravni kut strujanja zraka potrebno je postaviti ručno. Stisnite šipku deflektora (vidi sl. B) i ručno je podesite u željenom smjeru. Kod nekih jedinica, vodoravni kut strujanja zraka moguće je namjestiti pomoću daljinskog upravljača, pročitajte Priručnik za daljinsko upravljanje.

3.7 Ugradite komplet HomeWhiz (bežični modul)

1. Skinite zaštitni poklopac sa kompleta HomeWhiz (bežični modul)
2. Otvorite prednju ploču i umetnite komplet HomeWhiz (bežični modul) u rezervirano sučelje.

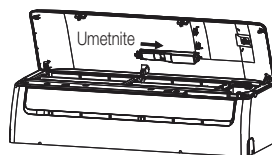
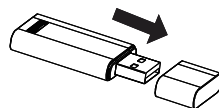

Upozorenje:

Ovo je sučelje kompatibilno samo sa kompletom HomeWhiz (bežični modul) koji osigurava proizvođač.

3 Specifikacije i značajke uređaja

3.8 Ručni rad (bez daljinskog upravljača)



OPREZ! Gumb za ručno upravljanje namijenjen je isključivo za svrhe testiranja i za rad u izvanrednim slučajevima. Nemojte koristiti ovu funkciju osim ako niste izgubili daljinski upravljač i stoga je to neophodno. Za povratak na uobičajeni rad, aktivirajte uređaj pomoću daljinskog upravljača. Uređaj je potrebno isključiti prije ručnog upravljanja.

Da biste uređajem upravljali ručno:

1. Otvorite prednju ploču unutarnje jedinice.
2. Pronađite gumb Manual Control (Ručno Upravljanje) s desne strane uređaja.
3. Pritisnite gumb Manual Control (Ručno Upravljanje) jednom da biste aktivirali način rada Forced Auto (Prisilan Automatski Rad).
4. Pritisnite gumb Manual Control (Ručno Upravljanje) ponovno da biste aktivirali način rada Forced Cooling (Prisilno Hlađenje).
5. Pritisnite gumb Manual Control (Ručno Upravljanje) po treći put da biste isključili uređaj.
6. Zatvorite prednju ploču.

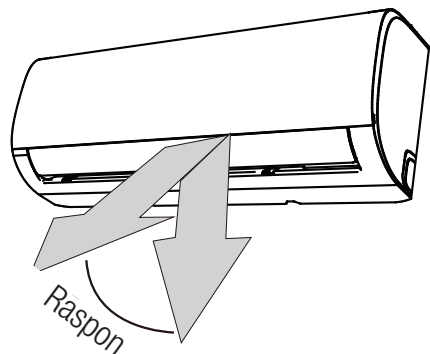

Nemojte pomicati lamele ručno. To će prouzročiti gubitak sinkronizacije kod lamela. Ako se to dogodi, isključite uređaj i izvucite utikač iz utičnice na kratko vrijeme, a zatim ponovno pokrenite uređaj. To će ponovno postaviti lamele za usmjeravanje zraka.



OPREZ! Nemojte stavljati prste unutar niti u blizinu ispušne ili usisne strane uređaja. Unutarnji ventilator koji se brzo okreće može prouzročiti ozljede.

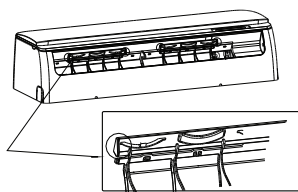

Šipka deflektora (usmjerivača)

Sl. B

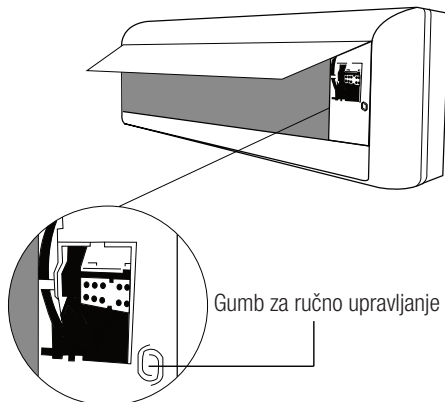

Gumb za ručno upravljanje

4 Ugradnja

4.1 Sažetak postupka ugradnje – unutarnja jedinica

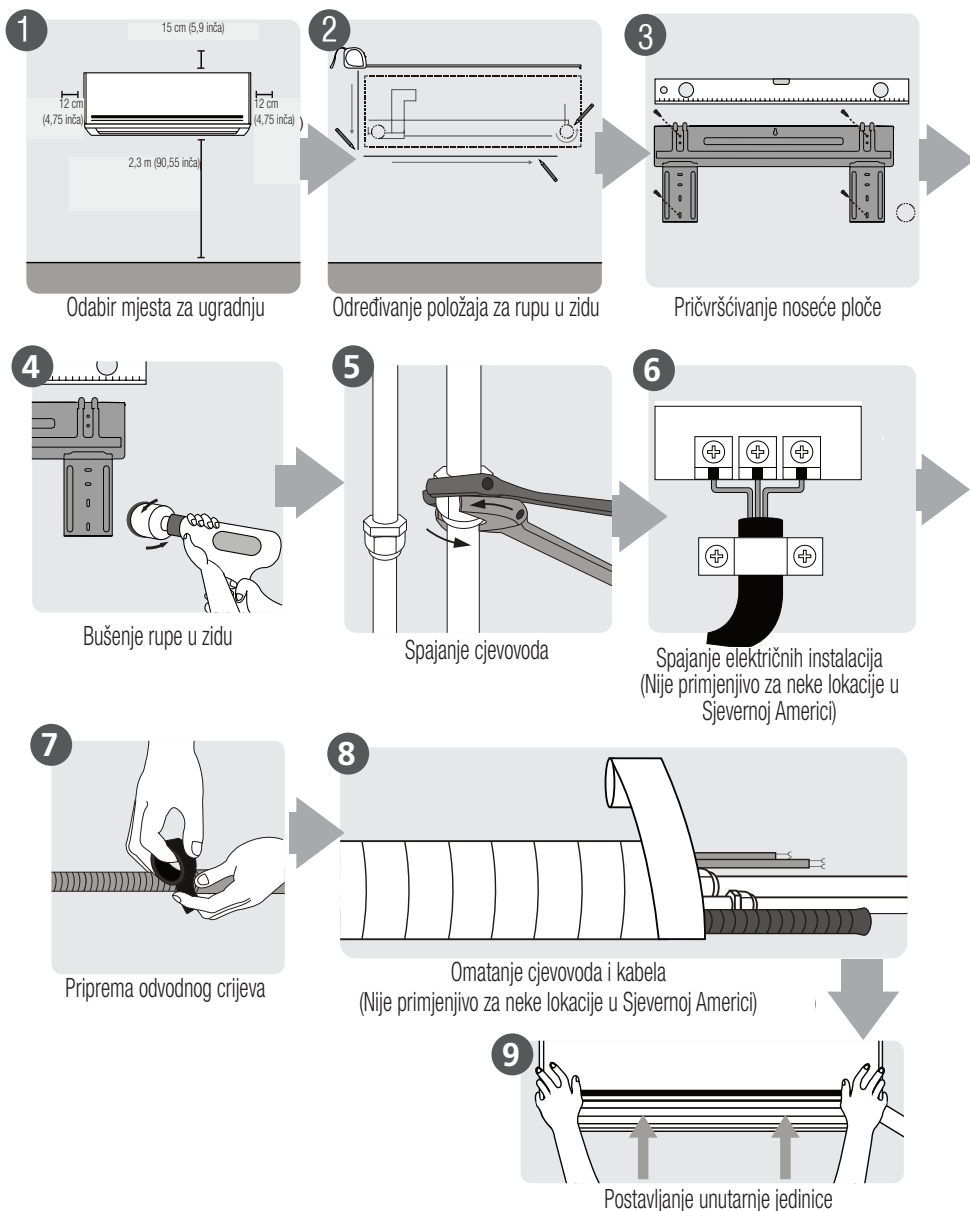

4 Ugradnja

4.2 Upute za ugradnju – unutarnja jedinica

4.2.1 Prije ugradnje

Prije ugradnje unutarnje jedinice pogledajte naljepnicu s ambalaže proizvoda da biste provjerili odgovara li broj modela unutarnje jedinice broju modela vanjske jedinice.

1. korak: Odaberite mjesto ugradnje. Prije ugradnje unutarnje jedinice morate odabrati odgovarajuće mjesto. U nastavku su navedeni standardi koji će vam pomoći da odaberete prikladno mjesto za jedinicu.

Prikladna mjesta za ugradnju ispunjavaju sljedeće standarde:

- Dobra cirkulacija zraka
- Omogućuje jednostavan odvod kondenzata
- Zvukovi koji nastaju prilikom rada uređaja neće ometati druge ljude
- Čvrsto i stabilno — na odabranom mjestu nema vibracija
- Dovoljno čvrsto da podnese masu jedinice
- Mjesto je udaljeno najmanje jedan metar od drugih električnih uređaja (npr. TV, radio, računalo)

NEMOJTE ugrađivati jedinicu na sljedećim mjestima:

- Blizu bilo kakvog izvora topline, pare ili zapaljivog plina
- Blizu zapaljivih predmeta kao što su zastori ili odjeća
- Blizu bilo kakvih prepreka koje bi mogle blokirati cirkulaciju zraka
- Blizu vrata
- Na mjestu gdje bi jedinica bila izložena izravnoj sunčevoj svjetlosti



Ako nema fiksnog cjevovoda za rashladno sredstvo: Prilikom odabira lokacije imajte na umu da je potrebno ostaviti dovoljno prostora za rupu u zidu (vidjeti korak Bušenje rupe u zidu za spojni cjevovod) kroz koju ćete provući signalni kabel i cjevovod za rashladno sredstvo koji povezuju unutarnje i vanjske jedinice. Uobičajeni je položaj za cjevovod s desne strane unutarnje jedinice (kada gledate jedinicu sprijeda). Međutim, cjevovod se može spojiti s lijeve i s desne strane.

Pogledajte sljedeću shemu da biste mogli ostaviti odgovarajući razmak od zidova i stropa:

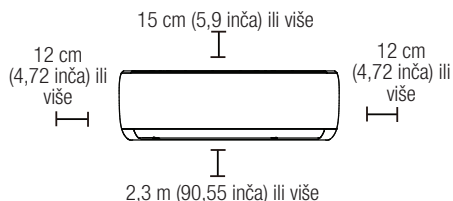

2. korak: Pričvršćivanje noseće ploče na zid
Noseća ploča je element na koji ćete postaviti unutarnju jedinicu.

- Uklonite vijak kojim se noseća ploča pričvršćuje na stražnji dio unutarnje jedinice.

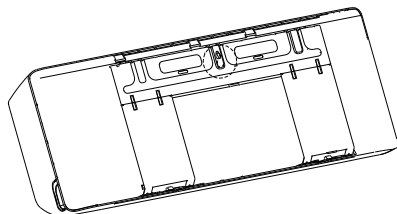

4 Ugradnja

- Pričvrstite noseću ploču na zid pomoću dostavljenih vijaka. Provjerite je li noseća ploča postavljena ravno uz zid.



Ako je zid izrađen od opeke, betona ili sličnog materijala, izbušite rupe promjera 5 mm (0,2 inča) u zidu i umetnite tiple koje su dostavljene uz uređaj. Zatim pričvrstite noseću ploču na zid tako da stavite vijake izravno u tiple i zategnete ih.

3. korak: Bušenje rupe u zidu za spojni cjevovod
1. Odredite mjesto rupe na zidu s obzirom na položaj noseće ploče. Pogledajte dimenzije noseće ploče.
2. S pomoću udarne bušilice od 65 mm (2,5 inča) ili 90 mm (3,54 inča) (ovisno o modelima) izbušite rupu u zidu. Rupu bušite pod blagim kutom prema dolje tako da izlazni kraj rupe bude niži od ulaznog kraja za otprilike 5 do 7 mm (0,2 – 0,275 inča). To će osigurati pravilan odvod vode.
3. Stavite zaštitnu zidnu manžetu u rupu. Ona će zaštititi rubove rupe i pomoći će vam da je zavrtnete nakon što završite postupak ugradnje.



OPREZ! Prilikom bušenja rupe u zidu budite oprezni da ne biste oštetili električne ili vodovodne instalacije, kao ni druge osjetljive dijelove.

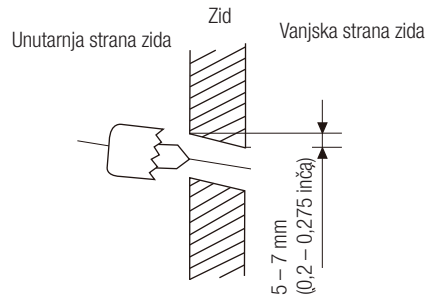

4.2.2 Dimenzije noseće ploče

Različiti modeli imaju različite noseće ploče. Zbog različitih zahtjeva prilagodbe, oblik noseće ploče može se malo razlikovati. No dimenzije ugradnje iste su za unutarnju jedinicu iste veličine. Za primjer pogledajte tip A i tip B:

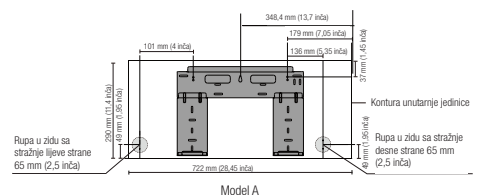
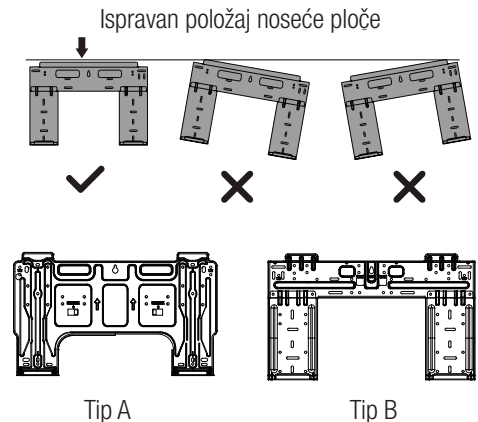

4 Ugradnja

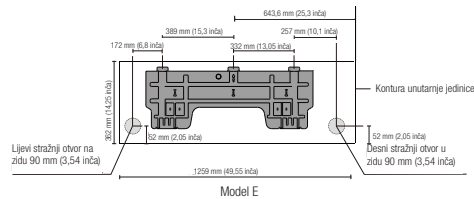
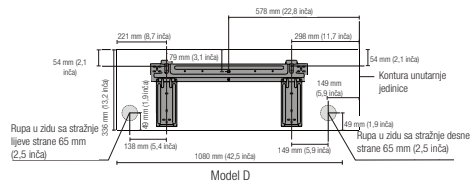
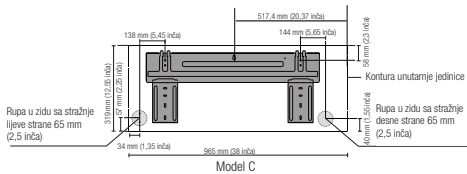
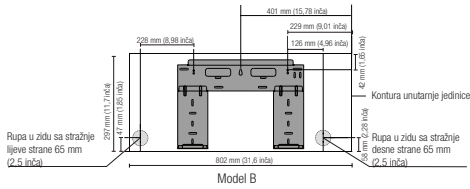

Kad je spojna cijev na strani plina 16 mm (5/8 inča) ili više, otvor u zidu treba biti 90 mm (3,54 inča).

1. Na temelju položaja rupe u zidu u odnosu na noseću ploču odaberite stranu s koje će cjevovod izaći iz jedinice.
2. Ako se rupa u zidu nalazi iza jedinice, nemojte dirati dio ploče koji se može ukloniti. Ako se rupa u zidu nalazi sa strane unutarnje jedinice, uklonite plastični dio ploče s te strane jedinice. Na taj ćete način dobiti otvor kroz koji cjevovod može izaći iz jedinice. Ako se plastični dio ploče ne može ukloniti rukom, upotrijebite šiljasta kliješta.
3. U ploči za izbijanje napravljen je kanal kako bi se ista prikladno izrezala. Veličinu otora određuje promjer cjevovoda.

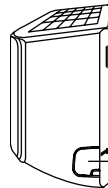

Zidna ploča

4. Ako je postojeći spojni cjevovod već ugrađen u zid, nastavite od koraka Povezivanje odvodnog crijeva. Ako cjevovod nije ugrađen, spojite cjevovod za rashladno sredstvo unutarnje jedinice na spojni cjevovod koji će spajati unutarnju i vanjsku jedinicu. Pogledajte odjeljak Spajanje cjevovoda za rashladno sredstvo iz ovog priručnika za daljnje upute.



Cjevovod rashladnog sredstva može izlaziti iz unutarnje jedinice iz četiri različita kuta: s lijeve strane, s desne strane, s lijeva straga, s desna straga.

4. korak: Priprema cjevovoda za rashladno sredstvo

Cjevovod za rashladno sredstvo nalazi se unutar izolacijske cijevi spojene na stražnji dio jedinice. Cjevovod je potrebno pripremiti prije no što ga provučete kroz rupu u zidu.

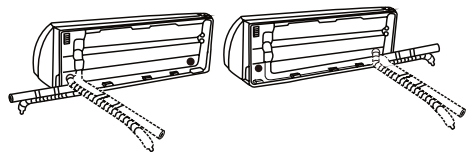

4 Ugradnja



OPREZ! Budite vrlo pažljivi da ne biste udubili ili oštetili cjevovod kada ga budete savijali. Bilo kakve udubine na cjevovodu utjecat će na učinkovitost jedinice.

5. korak: Spajanje odvodnog crijeva

Obično se odvodno crijevo spaja s lijeve strane jedinice (kada gledate jedinicu straga). Međutim, može se spojiti i s desne strane. Da biste osigurali pravilan odvod, spojite odvodno crijevo s iste strane jedinice iz koje izlazi cjevovod za rashladno sredstvo. Spojite produžetak odvodnog crijeva (nabavlja se zasebno) na kraj odvodnog crijeva.

- Čvrsto omotajte spojno mjesto trakom za brtvljenje kako biste bili sigurni da je brtva čvrsta i spriječili curenje.
- Dio odvodnog crijeva koji će ostati unutra izolirajte pjenom da biste spriječili nastanak kondenzacije.
- Maknite filtar za zrak i ulijte malu količinu vode u posudu za odvod kako biste provjerili teče li voda nesmetano iz jedinice.



Vodite računa da odvodno crijevo rasporedite u skladu sa sljedećim slikama.

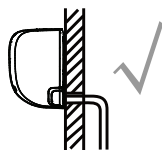

ISPRAVNO

Kako biste osigurali pravilan odvod vode kroz odvodno crijevo, pazite da ne bude savijeno pod oštrim kutom i da nema udubina.

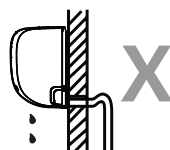

POGREŠNO

Odvodno crijevo savijeno pod oštrim kutom stvorit će vodene sifone.

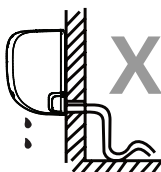

POGREŠNO

Odvodno crijevo savijeno pod oštrim kutom stvorit će vodene sifone.

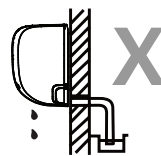

POGREŠNO

Nemojte stavljati krajeve odvodnog crijeva u vodu ili u spremnik za skupljanje vode. To će onemogućiti pravilan odvod vode.

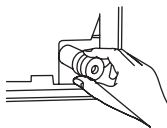

Zatvorite nekorišteni odvodni otvor. Kako biste spriječili curenje, potrebno je zatvoriti nekorišteni odvodni otvor pomoću dostavljenog gumenog čepa.

4.2.3 Prije izvođenja bilo kakvih električnih radova, pročitajte ove propise

1. Sve ožičenje mora biti u skladu s lokalnim i nacionalnim električnim propisima, te isto treba provesti licencirani električar.
2. Svi se električni spojevi moraju izvesti u skladu sa shemom električnih spojeva koja se nalazi na pločama unutarnje i vanjske jedinice.
3. Rad treba odmah prekinuti ako postoji ozbiljan sigurnosni problem s napajanjem. Objasnite svoj razlog klijentu i odbijte ugraditi jedinicu dok se sigurnosni problem ne otkloni.

4 Ugradnja

- Napon napajanja trebao bi biti unutar 90 – 110 % nazivnog napona. Nedovoljno napajanje može prouzročiti kvar, strujni udar ili požar.
- Ako spajate struju na fiksno ožičenje, morate ugraditi prednaponsku zaštitu i glavni strujni prekidač.
- Ako spajate napajanje s fiksnim električnim instalacijama, obavezno je postaviti sklopku (ili prekidač) koja odspaja sve polove i ima razmak kontakta od najmanje 1/8 inča (3 mm) u fiksne električne instalacije. Kvalificirani tehničar mora koristiti odobreni prekidač ili sklopku.
- Jedinicu priključite samo na utičnicu zasebne grane kruga. Nemojte priključivati drugi uređaj na tu utičnicu.
- Klima uređaj mora se pravilno uzemljiti.
- Svaka žica mora biti čvrsto spojena. Labavi spojevi žica mogu prouzročiti zagrijavanje rednih stezaljki što će dovesti do neispravnog funkcioniranja proizvoda i mogućeg požara.
- Nemojte dopustiti da žice dodiruju ili da se oslanjaju na cjevovod za rashladno sredstvo, kompresor ili na bilo koji pokretni dio u jedinici.
- Ako jedinica ima pomoćni električni grijač, mora je se ugraditi na udaljenosti od najmanje 1 metra (40 inča) dalje od bilo kakvih zapaljivih materijala.
- Kako biste izbjegli strujni udar, nikada ne dodirujte električne dijelove brzo nakon isključenja električnog napajanja. Nakon isključenja napajanja, uvijek pričekajte 10 minuta ili više prije diranja električnih komponenti.



UPOZORENJE! Potrebno je isključiti glavno napajanje do sustava prije izvođenja bilo kakvih električarskih radova ili radova na električnim instalacijama.

6. korak: Spajanje signalnih kabela i kabela za napajanje

Signalni kabel omogućuje komunikaciju između unutarnje i vanjske jedinice. Prije pripremanja kabela za spajanje prvo je potrebno odabrati kabel prikladne veličine.

Vrste kabela

- Kabel za napajanje unutarnje jedinice (po potrebi): H05VV-F ili H05V2V2-F
- Kabel za napajanje vanjske jedinice: H07RN-F ili H05RN-F
- Signalni kabel: H07RN-F



U Sjevernoj Americi, odaberite vrstu kabela prema lokalnim električnim propisima.

Minimalno područje poprečnog presjeka strujnih i signalnih kabela (za referencu) (ne primjenjuje se u Sjevernoj Americi)

Nazivna struja uređaja (A)	Nominalna površina poprečnog presjeka (mm ²)
> 3 i ≤ 6	0,75
> 6 i ≤ 10	1
> 10 i ≤ 16	1,5
> 16 i ≤ 25	2,5
> 25 i ≤ 32	4
> 32 i ≤ 40	6

Veličina potrebnog kabela za napajanje, signalnog kabela, osigurača i potrebne sklopke određuje se u skladu s najjačom strujom uređaja. Najjača struja navedena je na pločici koja se nalazi na bočnoj ploči uređaja. Pogledajte podatke s te pločice

4 Ugradnja

da biste odabrali odgovarajući kabel, osigurač ili odgovarajuću sklopku.



U Sjevernoj Americi, odaberite ispravnu veličinu kabela u skladu s minimalnim kapacitetom kruga navedenim na nazivnoj pločici jedinice.

1. Otvorite prednju ploču unutarnje jedinice.
2. Pomoću odvijača otvorite pokrivač odjeljka sa žicama na desnoj strani jedinice. Tako ćete doći do rednih stezaljki.

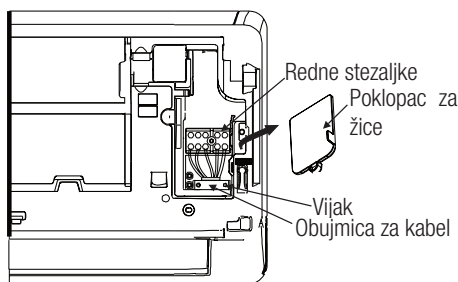

UPOZORENJE! Sve ožičenje mora se provesti strogo u skladu s dijagramom ožičenja smještenom na stražnjoj strani prednje ploče unutarnje jedinice.

3. Odvijte obujnicu kabela ispod rednih stezaljki i stavite je sa strane.
4. Kada gledate jedinicu straga, uklonite plastičnu ploču s donje lijeve strane.
5. Provucite signalnu žicu kroz to, od stražnje strane jedinice do prednje.
6. Okrenuti prema prednjoj strani jedinice, spojite žicu prema dijagramu ožičenja unutarnje jedinice, spojite u-stopicu i čvrsto pričvrstite svaku žicu na odgovarajuću stezaljku.



OPREZ! Nemojte pomiješati žice pod naponom s onima koje nisu pod naponom. To je opasno i može prouzročiti kvar klima uređaja.

7. Nakon što provjerite jesu li svi spojevi sigurni, pričvrstite signalni kabel na uređaj pomoću obujmice za kabel. Čvrsto zategnite obujmicu za kabel.
8. Vratite poklopac za žice na prednju stranu jedinice, a plastičnu ploču na stražnji.



Postupak povezivanja ožičenja može se lagano razlikovati između jedinica i regija.

7. korak: Omotavanje i kablovi
- Prije provođenja cjevovoda, crijeva za odvod i signalnog kabela kroz otvor u zidu, morate ih spojiti u snop kako biste uštedjeli prostor, zaštitili ih i izolirali (ne primjenjuje se u Sjevernoj Americi).
1. Odvodno crijevo, cijevi za rashladno sredstvo i signalni kabel spojite u snop kao što je prikazano u nastavku:

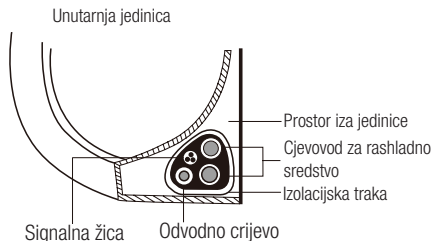

4 Ugradnja



Provjerite nalazi li se odvodno crijevo na dnu snopa. Postavljanje odvodnog crijeva na gornji dio snopa može dovesti do prelijevanja iz posude za odvod, što može dovesti do oštećenja uzrokovanih vodom ili požara.



OPREZI! Kada budete spajali te predmete u snop, nemojte ispreplitati signalni kabel s bilo kakvim drugim električnim instalacijama.

2. Pomoću ljepljive vinilne trake spojite odvodno crijevo s donjim dijelom cijevi za rashladno sredstvo.
3. Pomoću izolacijske trake zajedno omotajte signalnu žicu, cijevi za rashladno sredstvo i odvodno crijevo. Dvaput provjerite da su sve stavke spojene u snop.



OPREZI! Prilikom omatanja cjevovoda, nemojte omotati krajeve cjevovoda. Na kraju postupka ugradnje bit će vam potreban pristup do njih kako biste provjerili curi li što (pogledajte odjeljak Električne provjere i provjere curenja iz ovog priručnika).

8. korak: Postavljanje unutarnje jedinice

Ako ste ugradili novi spojni cjevovod do vanjske jedinice, učinite sljedeće:

1. Ako ste već provukli cjevovod za rashladno sredstvo kroz rupu u zidu, nastavite do 4. koraka.
2. U suprotnom, dobro provjerite jesu li cijevi za rashladno sredstvo zabrtvljene kako bi se spriječilo prodiranje prljavštine i stranih tvari u cijevi.

3. Polako provucite omotani snop cijevi za rashladno crijevo, odvodnog crijeva i signalnog kabela kroz rupu u zidu.

4. Postavite vrh unutarnje jedinice na gornju kuku noseće ploče.

5. Provjerite je li jedinica čvrsto postavljena na noseću ploču blagim pritiskom na lijevu i desnu stranu jedinice. Jedinica se ne bi trebala tresti niti pomicati.

6. Primijenite ravnomjerni pritisak prema dolje na donju polovicu jedinice. Nastavite primjenjivati pritisak prema dolje dok jedinica ne sjedne na kuke koje se nalaze pri dnu noseće ploče.

7. Ponovno provjerite je li jedinica čvrsto postavljena na noseću ploču blagim pritiskom na lijevu i desnu stranu jedinice.

Ako je cjevovod za rashladno sredstvo već ugrađen u zid, učinite sljedeće:

1. Postavite vrh unutarnje jedinice na gornju kuku noseće ploče.

2. Pomoću držača ili klina poduprite jedinicu te na taj način ostavite dovoljno prostora da spojite cjevovod za rashladno sredstvo, signalni kabel i odvodno crijevo.

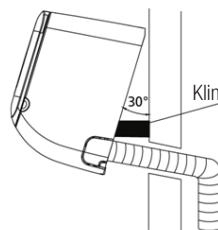

3. Spojite odvodno crijevo i cjevovod za rashladno sredstvo (pogledajte odjeljak Spajanje cjevovoda za rashladno sredstvo iz ovog priručnika za daljnje upute).

4. Ostavite spojnu točku cijevi izloženom da biste mogli obaviti ispitivanje nepropusnosti (pogledajte odjeljak Električne provjere i provjere curenja iz ovog priručnika).

4 Ugradnja

5. Nakon što obavite ispitivanje nepropusnosti, omotajte spojnu točku izolacijskom trakom.
6. Uklonite držač ili klin koji podupire jedinicu.
7. Primijenite ravnomjerni pritisak prema dolje na donju polovicu jedinice. Nastavite primjenjivati pritisak prema dolje dok jedinica ne sjedne na kuke koje se nalaze pri dnu noseće ploče.

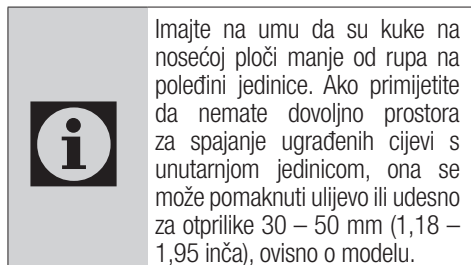

4.3 Ugradnja vanjske jedinice

Ugradite jedinicu poštujući lokalne propise, mogu se neznatno razlikovati u različitim regijama.

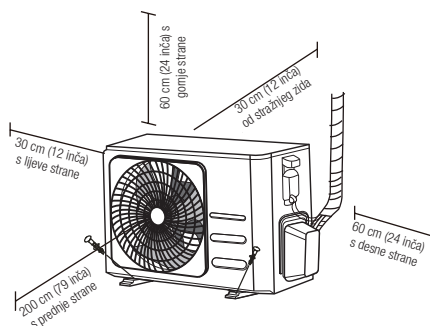

4.3.1 Upute za ugradnju – Vanjska jedinica

1. korak: Odabir mjesta za ugradnju
Prije same ugradnje vanjske jedinice potrebno je odabrati prikladno mjesto za ugradnju. U nastavku su navedeni standardi koji će vam pomoći da odaberete prikladno mjesto za jedinicu.

Prikladna mjesta za ugradnju ispunjavaju sljedeće standarde:

- Udovoljava svim prostornim zahtjevima navedenim iznad u Zahtjevima za prostorom za ugradnju.
 - Dobra cirkulacija i ventilacija zraka
 - Čvrsto i stabilno – odabrano mjesto može nositi masu jedinice i na tom mjestu neće biti vibracija
 - Zvukovi koji nastaju prilikom rada uređaja neće ometati druge
 - Zaštićeno od produljenih razdoblja tijekom kojih je uređaj izložen izravnoj sunčevoj svjetlosti ili kiši
 - Tamo gdje se predviđa snijeg, podignite jedinicu iznad baznog podnožja kako biste spriječili nakupljanje leda i oštećenje zavojnice. Jedinicu ugradite dovoljno visoko kako bi se nalazila iznad prosječno akumulirane površine snijega. Minimalna visina mora biti 18 inča.
- #### NEMOJTE ugrađivati jedinicu na sljedećim mjestima:
- Blizu prepreka koje mogu blokirati otvore za ulaz i izlaz zraka
 - Blizu javnih ulica, prostora s puno ljudi ili mjesta gdje će buka jedinice smetati drugim ljudima
 - Blizu životinja ili biljki na koje vrući izlazni zrak negativno djeluje
 - Blizu bilo kakvog izvora zapaljivog plina
 - Na mjestu s velikom količinom prašine.

4 Ugradnja

- Na mjestu koje je izloženo velikim količinama morskog zraka.



Ako je jedinica izložena snažnom vjetru: Jedinicu ugradite tako da ventilator za izlaz zraka bude pod kutom od 90 ° u odnosu na smjer vjetra. Po potrebi napravite zaklon ispred jedinice da biste je zaštitili od iznimno jakog vjetra. Pogledajte slike u nastavku.

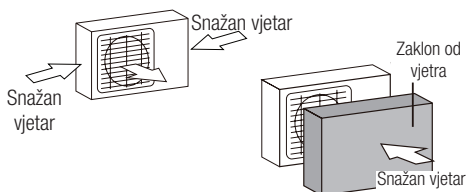

Ako se jedinica često izlaže pljuskovima ili snijegu: Izgradite zaštitu iznad jedinice kako biste je zaštitili od kiše ili snijega. Pripazite da ne biste spriječili protok zraka oko jedinice.

Ako se jedinica često izlaže morskome zraku (priobalje): Koristite vanjsku jedinicu posebno osmišljenu da bi bila otporna na korozivno djelovanje.

2. korak: Ugradite priključak za odvod (samo jedinica toplinske pumpe)

Prije no što fiksirate vanjsku jedinicu na svoje mjesto potrebno je ugraditi priključak za odvod na dno jedinice. Imajte na umu da postoje dvije različite vrste priključaka za odvod, ovisno o vrsti vanjske jedinice.

Ako su priključci za odvod isporučeni s gumenom brtvom (vidi sl. A), učinite sljedeće:

1. Stavite gumenu brtvu na kraj priključka za odvod koji ćete povezati s vanjskom jedinicom.
2. Umetnite priključak za odvod u otvor na donjoj strani jedinice.
3. Okrenite priključak za odvod za 90 ° dok ne sjedne na svoje mjesto te bude okrenut prema prednjem dijelu jedinice.
4. Spojite produžetak odvodnog crijeva (ne isporučuje se s proizvodom) s priključkom za odvod kako biste usmjerili vodu iz uređaja dok je aktivan način rada grijanje.

Ako se uz priključak za odvod ne isporučuje gumena brtva (vidi sl. B), učinite sljedeće:

1. Umetnite priključak za odvod u otvor na donjoj strani jedinice. Priključak za odvod sjest će na svoje mjesto.
2. Spojite produžetak odvodnog crijeva (ne isporučuje se s proizvodom) s priključkom za odvod kako biste usmjerili vodu iz uređaja dok je aktivan način rada grijanje.

4 Ugradnja

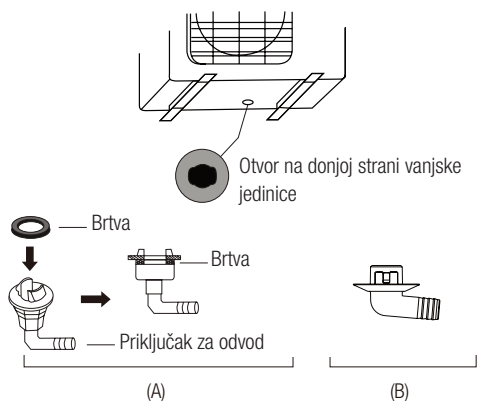

3. korak: Pričvršćivanje vanjske jedinice

Vanjska jedinica može se pričvrstiti na pod ili na zidnu konzolu pomoću vijka (M10). Pripravite podlogu za ugradnju jedinice prema dimenzijama iz nastavka.



U nastavku se nalazi popis različitih veličina vanjskih jedinica i udaljenosti između montažnih nogica tih jedinica. Pripravite podlogu za ugradnju jedinice prema dimenzijama iz nastavka.



OPREZ! U hladnijim klimatskim područjima postavite crijevo za odvod u što okomitiji položaj moguć da biste osigurali brzi odvod vode. Ako se voda presporo odvodi, može se zamrznuti u crijevu i tako poplaviti jedinicu.

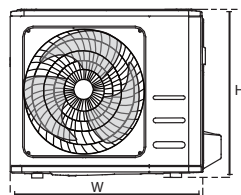
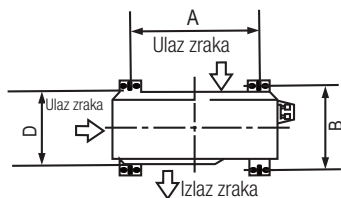

Dimenzija vanjske jedinice (mm)	Dimenzije za montažu	
	Š x V x D	Udaljenost A (mm)
681 x 434 x 285 (26,8" x 17,1" x 11,2")	460 (18,1")	292 (11,5")
700 x 550 x 270 (27,5" x 21,6" x 10,6")	450 (17,7")	260 (10,2")
700 x 550 x 275 (27,5" x 21,6" x 10,8")	450 (17,7")	260 (10,2")
720 x 495 x 270 (28,3" x 19,5" x 10,6")	452 (17,8")	255 (10,0")
728 x 555 x 300 (28,7" x 21,8" x 11,8")	452 (17,8")	302 (11,9")
765 x 555 x 303 (30,1" x 21,8" x 11,9")	452 (17,8")	286 (11,3")
770 x 555 x 300 (30,3" x 21,8" x 11,8")	487 (19,2")	298 (11,7")
805 x 554 x 330 (31,7" x 21,8" x 12,9")	511 (20,1")	317 (12,5")

4 Ugradnja

Dimenzija vanjske jedinice (mm)	Dimenzije za montažu	
	Š x V x D	Udaljenost A (mm)
800 x 554 x 333 (31,5" x 21,8" x 13,1")	514 (20,2")	340 (13,4")
845 x 702 x 363 (33,3" x 27,6" x 14,3")	540 (21,3")	350 (13,8")
890 x 673 x 342 (35,0" x 26,5" x 13,5")	663 (26,1")	354 (13,9")
946 x 810 x 420 (37,2" x 31,9" x 16,5")	673 (26,5")	403 (15,9")
946 x 810 x 410 (37,2" x 31,9" x 16,1")	673 (26,5")	403 (15,9")

Ako namjeravate ugraditi jedinicu na tlo ili na betonsku montažnu platformu, učinite sljedeće:

1. Označite položaj za četiri ekspanziona vijka na temelju grafikona dimenzija.
2. Unaprijed izbušite rupe za sidrene vijke.
3. Stavite maticu na kraj svih sidrenih vijaka.
4. Čekićem zabijte sidrene vijke u prethodno izbušene rupe.
5. Odvijte matice sa sidrenog vijka i stavite vanjsku jedinicu na vijke.
6. Stavite podložnu pločicu na svaki sidreni vijak, a zatim ponovno vratite matice.
7. Svaku maticu zategnite do kraja pomoću ključa.



UPOZORENJE! Prilikom bušenja u beton, preporučeno je koristiti zaštitu za oči cijelo vrijeme.

Ako namjeravate postaviti jedinicu na zidni nosač, učinite sljedeće:



OPREZ! Uvjerite se da je zid napravljen od pune cigle, betona ili sličnog čvrstog materijala. Zid mora biti u stanju nositi masu koja je najmanje četiri puta veća od mase jedinice.

1. Označite položaj otvora na konzoli na temelju dijagrama dimenzija.
 2. Unaprijed izbušite rupe za sidrene vijke.
 3. Stavite podložnu pločicu i maticu na kraj svih sidrenih vijaka.
 4. Uvijte sidrene vijke kroz rupe u zidnom nosaču, postavite zidne nosače na obilježeni položaj i čekićem zabijte sidrene vijke u zid.
 5. Provjerite jesu li zidni nosači nivelirani.
 6. Pažljivo podignite jedinicu na svoj položaj i postavite montažne nogice jedinice na nosače.
 7. Stavite i čvrsto stegnite vijke koji pričvršćuju jedinicu na zidne nosače.
 8. Ako je dopušteno, ugradite jedinicu s gumenim brtvama kako biste smanjili vibracije i buku.
4. korak: Spajanje signalnih kabela i kabela za napajanje

Redne stezaljke vanjske jedinice nalaze se ispod poklopca za žice koji se nalazi na bočnoj strani jedinice.

Detaljna shema električnih instalacija otisnuta je unutrašnjoj strani poklopca za žice.



UPOZORENJE! Potrebno je isključiti glavno napajanje do sustava prije izvođenja bilo kakvih električarskih radova ili radova na električnim instalacijama.

4 Ugradnja

1. Pripremanje kabela za spajanje: Odaberite ispravan kabel u skladu s odjeljkom „Vrste kabela“ na str. 83.



Veličina potrebnog kabela za napajanje, signalnog kabela, osigurača i potrebne sklopke određuje se u skladu s najjačom strujom uređaja. Najjača struja navedena je na pločici koja se nalazi na bočnoj ploči uređaja.



U Sjevernoj Americi, odaberite ispravnu veličinu kabela u skladu s minimalnim kapacitetom kruga navedenim na nazivnoj pločici jedinice.

- Pomoću kliješta za skidanje izolacije skinite gumenu izolaciju s oba kraja kabela do otprilike 40 mm (1,57 inča).
- Skinite izolaciju s oba kraja žica.
- Pomoću kliješta za stiskanje, pričvrstite ušice u tipa na krajeve žica.



Dok stišćete žice, potrebno je jasno razlikovati žice pod naponom („L“) od drugih žica.



UPOZORENJE! Svi radovi ožičenja moraju se izvesti strogo u skladu s dijagramom ožičenja smještenim unutar poklopca za žice vanjske jedinice.

2. Odvijte poklopac za žice i uklonite ga.
3. Odvijte obujmicu kabela ispod rednih stezaljki i stavite je sa strane.
4. Spojite žicu prema dijagramu ožičenja i čvrsto zavrните u-stopicu svake žice u njenu odgovarajuću stezaljku.

5. Nakon što provjerite i ustanovite da je svaki spoj dobro stegnut, omotajte žice okolo da biste spriječili prodiranje kišnice do rednih stezaljki.
6. Pričvrstite kabel na jedinicu pomoću obujmice za kabel. Čvrsto zategnite obujmicu za kabel.
7. Izolirajte nekorištene žice pomoću PVC trake za električnu izolaciju. Rasporedite ih tako da ne dodiruju električne ili metalne dijelove.
8. Vratite poklopac za žice na bočnu stranu jedinice i pričvrstite ga na mjesto vijcima.

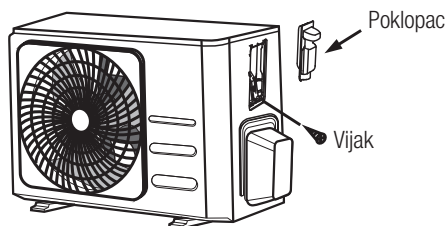

Ako držač kabela izgleda ovako, odaberite odgovarajući prolazni otvor prema promjeru žice.

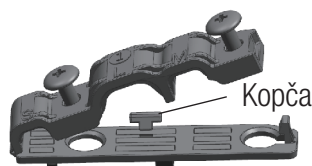

Rupa u tri veličine: Mala, velika, srednja

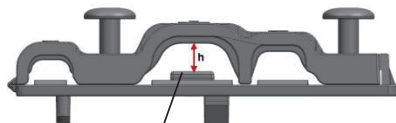

Kad kabel nije dovoljno pričvršćen, upotrijebite kopču kako biste ga poduprli, tako da se može čvrsto zategnuti.

4 Ugradnja

U Sjevernoj Americi

1. Skinite poklopac za žicu s jedinice otpuštanjem 3 vijka.
2. Demontirajte čepove na ploči s kabelima.
3. Privremeno montirajte provodljive cijevi (nisu uključene) na ploču s kabelima.
4. Ispravno spojite vodove strujnog napajanja i niskonaponske vodove na odgovarajuće stezaljke na bloku sa stezaljkama.
5. Uzemljite jedinicu u skladu s lokalnim propisima.
6. Odmjerite svaku žicu tako da bude nekoliko inča dulja od potrebne duljine za ožičenje.
7. Pomoću sigurnosnih matica učvrstite provodljive cijevi.

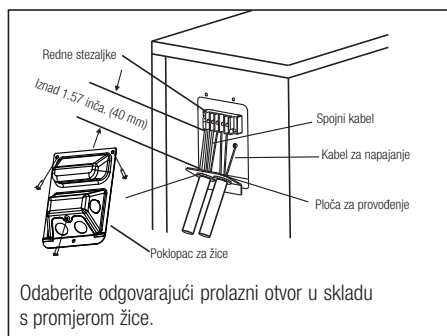

5 Spajanje cjevovoda za rashladno sredstvo

Prilikom spajanja cjevovoda za rashladno sredstvo, nemojte dopustiti da, osim propisanog rashladnog sredstva, u uređaj dospiju druge tvari ili plinovi. Prisutnost drugih plinova ili tvari smanjit će kapacitet uređaja i može prouzročiti nastanak neuobičajeno visokog tlaka u rashladnom krugu. To može dovesti do eksplozije i ozljeda.



Dužina cjevovoda za rashladno sredstvo utjecat će na radnu i energetska učinkovitost jedinice. Nazivna učinkovitost ispituje se na jedinicama s duljinom cijevi od 5 metara (16,5 stopa) (U Sjevernoj Americi standardna duljina cijevi je 7,5 m (25')). Minimalna dužina cijevi od 3 metra potrebna je za smanjivanje vibracija i prekomjerne buke. U posebnom tropskom području, za modele rashladnog sredstva R290, rashladno sredstvo se ne može dodavati i maksimalna duljina cijevi za rashladno sredstvo ne smije biti veća od 10 metara (32,8 stopa).

Pogledajte tablicu sa specifikacijama o najvećoj dopuštenoj dužini i visini pada cjevovoda u nastavku.

Maksimalna dužina i visina pada cjevovoda rashladnog sredstva po modelu jedinice

Model	Kapacitet (BTU/h)	Najveća dužina (m)	Najveća visina pada (m)
Klima uređaj split sistem inverter R410A, R32	< 15.000	25 (82 stope)	10 (33 stope)
	≥ 15.000 i < 24.000	30 (98,5 stopa)	20 (66 stopa)
	≥ 24.000 i < 36.000	50 (164 stope)	25 (82 stope)
Split klima uređaj fiksne brzine R22	< 18.000	10 (33 stope)	5 (16 stopa)
	≥ 18.000 i < 21.000	15 (49 stopa)	8 (26 stopa)
	≥ 21.000 i < 35.000	20 (66 stopa)	10 (33 stope)
Split klima uređaj fiksne brzine R410A, R32	< 18.000	20 (66 stopa)	8 (26 stopa)
	≥ 18.000 i < 36.000	25 (82 stope)	10 (33 stope)

5 Spajanje cjevovoda za rashladno sredstvo

5.1 Upute za spajanje – cjevovod rashladnog sredstva

1. korak: Rezanje cijevi

Prilikom pripremanja cijevi za rashladno sredstvo, dobro pripazite da ih pravilno proširite i izrežete. Tako ćete osigurati učinkoviti rad i smanjiti potrebu za održavanjem u budućnosti.

1. Izmjerite udaljenost između unutarnje i vanjske jedinice.
2. Prerežite cijev pomoću rezača cijevi tako da bude malo duža od izmjerene udaljenosti.
3. Provjerite je li cijev prerezana pod kutom od 90°.

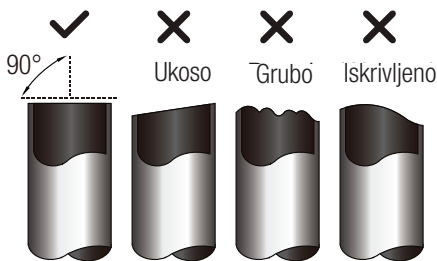

UPOZORENJE! Pazite da ne oštetite, udubite ili deformirate cijev prilikom rezanja. To će značajno smanjiti učinkovitost grijanja uređaja.

2. korak: Uklanjanje srha s ruba odrezane cijevi

Srhovi utječu na hermetičku zatvorenost spoja cjevovoda za rashladno sredstvo. Zato ih je potrebno u potpunosti ukloniti.

1. Cijev držite pod kutom prema dolje da biste spriječili pad skinutih srhova u cijev.
2. Uklonite srhove s dijela cijevi gdje je napravljen rez pomoću razvrtača ili alata za uklanjanje srha.

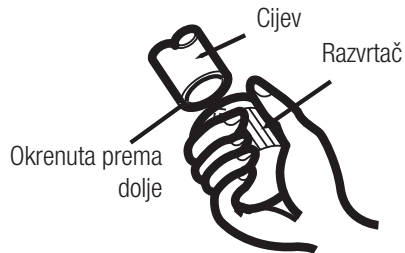

3. korak: Proširivanje krajeva cijevi

Pravilno je proširivanje cijevi ključno za izradu nepropusnog spoja.

1. Nakon što uklonite srhove s odrezane cijevi, zatvorite krajeve PVC trakom da biste spriječili prodiranje stranih materijala u cijev.
2. Omotajte cijev izolirajućim materijalom.
3. Stavite holender matice na oba kraja cijevi. Provjerite jesu li usmjerene u pravom smjeru jer ih nije moguće staviti ili im promijeniti smjer nakon proširivanja.

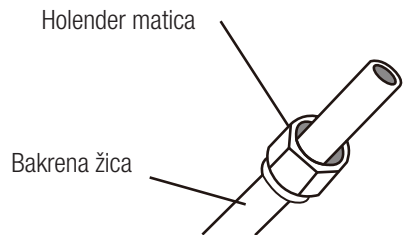

4. Uklonite PVC traku s krajeva cijevi kada budete spremni za proširivanje cijevi.

5. Kalup za izvođenje proširenja stegnite oko kraja cijevi. Kraj cijevi mora prelaziti rub kalupa u skladu s dimenzijama prikazanim u sljedećoj tablici.

5 Spajanje cjevovoda za rashladno sredstvo

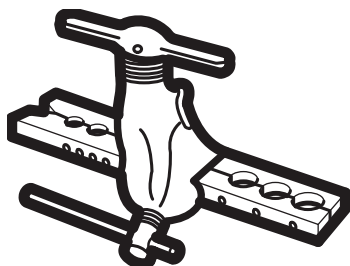

Prelaženje cijevi preko ruba kalupa

Vanjski promjer cijevi (mm)	A (mm)	
	Najmanje	Najviše
Ø 6,35 (Ø 0,25")	0,7 (0,0275")	1,3 (0,05")
Ø 9,52 (Ø 0,375")	1,0 (0,04")	1,6 (0,063")
Ø 12,7 (Ø 0,5")	1,0 (0,04")	1,8 (0,07")
Ø 16 (Ø 0,63")	2,0 (0,078")	2,2 (0,086")
Ø 19 (Ø 0,75")	2,0 (0,078")	2,4 (0,094")

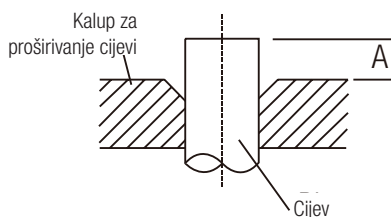

- Postavite alat za proširivanje cijevi na kalup.
- Okrećite ručicu alata za proširivanje cijevi u smjeru kazaljke na satu dok se cijev ne proširi u potpunosti.
- Uklonite alat za proširivanje cijevi i kalup, a zatim pregledajte kraj cijevi da biste provjerili ima li pukotina i je li se cijev jednoliko proširila.
4. korak: Spajanje cijevi

Prilikom spajanja cijevi za rashladno sredstvo pazite da ne primijenite prekomjeran okretni moment ili na neki drugi način deformirate cijevi. Prvo je potrebno spojiti niskotlačnu cijev, a zatim visokotlačnu cijev.



Ako budete savijali spojni cjevovod za rashladno sredstvo, najmanji polumjer zakrivljenosti mora iznositi 10 cm.

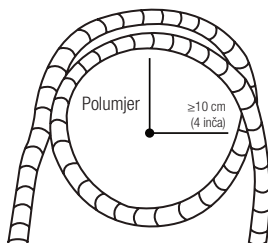

5.2 Upute za spajanje cjevovoda s unutarnjom jedinicom

- Poravnajte središta te dvije cijevi tako da ih možete spojiti.

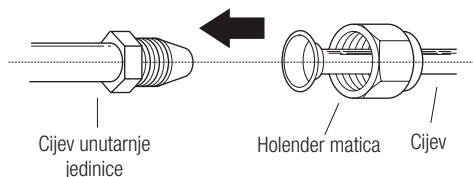

- Rukom pričvrstite holender maticu koliko je to moguće.
- Uхватite maticu na cijevi uređaja ključem.
- Dok čvrsto držite maticu na cijevi uređaja, pričvrstite holender maticu pomoću momentnog ključa prema vrijednostima za okretni moment navedenima u tablici sa zahtjevima za okretni moment iz nastavka. Malo olabavite holender maticu, a onda je ponovno stegnite.

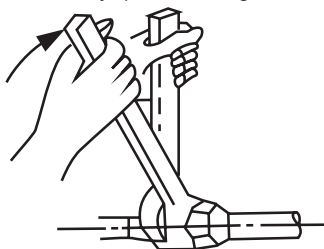

5 Spajanje cjevovoda za rashladno sredstvo

Zahtjevi za okretni moment

Vanjski promjer cijevi (mm)	Zatezni moment (N•m)	Dimenzije holendera (B) (mm)	Oblik holendera
Ø 6,35 (Ø 0,25")	18~20 (180~200 kgf.cm)	8,4~8,7 (0,33~0,34")	
Ø 9,52 (Ø 0,375")	32~39 (320~390 kgf.cm)	13,2~13,5 (0,52~0,53")	
Ø 12,7 (Ø 0,5")	49~59 (490~590 kgf.cm)	16,2~16,5 (0,64~0,65")	
Ø 16 (Ø 0,63")	57~71 (570~710 kgf.cm)	19,2~19,7 (0,76~0,78")	
Ø 19 (Ø 0,75")	67~101 (670~1010 kgf.cm)	23,2~23,7 (0,91~0,93")	



UPOZORENJE!

Primjena prekomjerne sile može oštetiti maticu ili cjevovod za rashladno sredstvo. Ne smijete prekoračiti zahtjeve za okretnim momentom koji su navedeni u tablici iznad.

6. Malo olabavite holender maticu, a onda je ponovno stegnite.

7. Ponovite korake 3 do 6 za preostalu cijev.



OPREZ!

Okretni moment primijenjen za pritezanje holender maticice može odlomiti druge dijelove ventila.

5.3 Upute za spajanje cjevovoda s vanjskom jedinicom

1. Odvijte poklopac zabrtvljenog ventila sa strane vanjske jedinice.
2. Uklonite zaštitne kapice s krajeva ventila.
3. Poravnajte kraj proširene cijevi s ventilom i rukom pričvrstite holender maticu koliko je to moguće.
4. Ključem uhvatite tijelo ventila. Nemojte uhvatiti maticu koja brtvi servisni ventil.

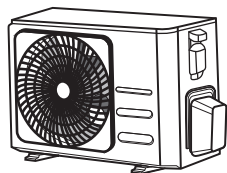
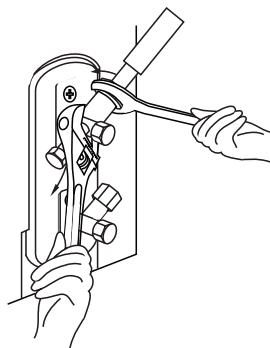

Poklopac za ventil

5. Dok čvrsto držite tijelo ventila, momentnim ključem stegnite holender maticu prema ispravnim vrijednostima za okretni moment.

6 Uklanjanje zraka

6.1 Pripremne radnje i mjere opreza

Zrak i strane tvari u rashladnom krugu mogu prouzročiti neuobičajen porast tlaka što može oštetiti klima uređaj, smanjiti učinkovitost uređaja i dovesti do ozljeda. Vakuurom pumpom i razdjelnim priključkom s manometrom izbacite sadržaj iz rashladnog kruga te na taj način uklonite nekondenzibilni plin i vlagu iz sustava.

To uklanjanje zraka trebalo bi se obaviti prilikom prve ugradnje i kada se jedinica bude premještala.

6.1.1 Prije izvođenja evakuacije

- Provjerite jesu li spojne cijevi između unutarnje i vanjske jedinice pravilno spojene.
- Provjerite jesu li sve električne instalacije pravilno spojene.

6.1.2 Upute za evakuaciju

1. Spojite crijevo za punjenje razdjelnog priključka s manometrom sa servisnim otvorom na niskotlačnom ventilu vanjske jedinice.
2. Spojite drugo crijevo za punjenje od razdjelnog priključka s manometrom do vakuumske pumpe.
3. Otvorite niskotlačnu stranu razdjelnog priključka s manometrom. Ostavite visokotlačnu stranu zatvorenom.
4. Uključite vakuurom pumpu da biste uklonili sadržaj iz sustava.
5. Pustite da vakuurom pumpa radi najmanje 15 minuta ili dok se na dvostranom manometru ne pokaže vrijednost -76 cmHg (-10^5 Pa).

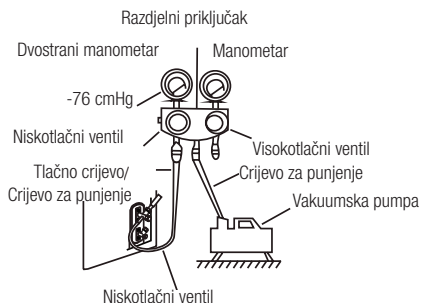

6. Zatvorite niskotlačnu stranu razdjelnog priključka s manometrom i isključite vakuurom pumpu.
7. Pričekajte 5 minuta, a zatim provjerite je li došlo do promjene tlaka u sustavu.
8. Ako je došlo do promjene tlaka u sustavu, pogledajte odjeljak Provjera propuštanja plina za informacije o tome kako provjeriti je li došlo do curenja. Ako nije došlo do promjene tlaka u sustavu, odvijte kapicu sa zabrtvljenog ventila (visokotlačni ventil).
9. Umetnite šesterokutni ključ u zabrtvljeni ventil (visokotlačni ventil) i otvorite ventil na način da okrenete ključ za $1/4$ okreta u smjeru suprotnom od kazaljke na satu. Poslušajte izlazi li plin iz sustava, a zatim zatvorite ventil nakon 5 sekundi.
10. Promatrajte manometar jednu minutu kako biste provjerili hoće li doći do promjene tlaka. Manometar bi trebao pokazivati vrijednost koja je malo viša od vrijednosti atmosferskog tlaka.
11. Uklonite crijevo za punjenje sa servisnog otvora.

6 Evakuacija zraka

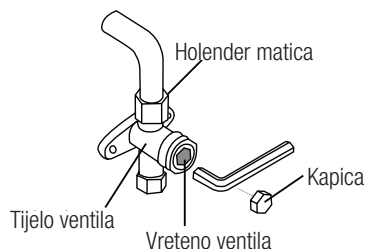

12. Pomoću šesterokutnog ključa u potpunosti otvorite visokotlačni i niskotlačni ventil.
13. Rukom stegnite kapice ventila na sva tri ventila (servisni otvor, visokotlačni, niskotlačni). Po potrebi ih možete dodatno stegnuti pomoću momentnog ključa.



OPREZ! Prilikom otvaranja ventilnog vretena, šesterokutni ključ okrenite do graničnika. Ne pokušavajte silom dalje otvarati ventil.

6.1.3 Napomena o dodavanju rashladnog sredstva

Kod nekih sustava će biti potrebno dodatno punjenje, ovisno o dužini cijevi. Standardna dužina cijevi varira u skladu s lokalnim propisima. Primjerice, u Sjevernoj Americi standardna dužina cijevi je 7,5 m (25 stopi). U drugim područjima standardna dužina cijevi je 5 m (16 stopi). Rashladno sredstvo treba puniti sa servisnog priključka na niskotlačnom ventilu vanjske jedinice. Dodatno rashladno sredstvo koje se treba dopuniti može se izračunati pomoću sljedeće formule:

6 Evakuacija zraka

Dodatno rashladno sredstvo ovisno o dužini cijevi

Dužina spojne cijevi (m)	Način pročišćavanja zrakom	Dodatno rashladno sredstvo	
< Standardna duljina cijevi	Vakuumska pumpa	nije primjenjivo	
> standardna dužina cijevi	Vakuumska pumpa	Strana s tekućinom: $\varnothing 6,35$ ($\varnothing 0,25''$) R32: (Dužina cijevi – standardna dužina) x 12 g/m (Dužina cijevi – standardna dužina) x 0,13 oz/ft R290: (Dužina cijevi – standardna dužina) x 10 g/m (Dužina cijevi – standardna dužina) x 0,10 oz/ft R410A: (Dužina cijevi – standardna dužina) x 15 g/m (Dužina cijevi – standardna dužina) x 0,16 oz/ft R22: (Dužina cijevi – standardna dužina) x 20 g/m (Dužina cijevi – standardna dužina) x 0,21 oz/ft	Strana s tekućinom: $\varnothing 9,52$ ($\varnothing 0,375''$) R32: (Dužina cijevi – standardna dužina) x 24 g/m (Dužina cijevi – standardna dužina) x 0,26 oz/ft (Dužina cijevi – standardna dužina) x 18 g/m (Dužina cijevi – standardna dužina) x 0,19 oz/ft R410A: (Dužina cijevi – standardna dužina) x 30 g/m (Dužina cijevi – standardna dužina) x 0,32 oz/ft R22: (Dužina cijevi – standardna dužina) x 40 g/m (Dužina cijevi – standardna dužina) x 0,42 oz/ft

Za jedinicu koja koristi rashladno sredstvo R290, ukupna količina rashladnog sredstva za punjenje ne smije biti viša od: 387 g (≤ 9000 Btu/h), 447 g (> 9000 Btu/h i ≤ 12000 Btu/h), 547 g (> 12000 Btu/h i ≤ 18000 Btu/h), 632 g (> 18000 Btu/h i ≤ 24000 Btu/h).



OPREZ! NEMOJTE miješati vrste rashladnih sredstava.

7 Električne provjere i provjere curenja plina

7.1 Prije probnog rada

Probni rad započnite isključivo nakon što završite sljedeće korake:

- Provjere vezane uz električnu sigurnost – provjerite je li električni sustav siguran i radi li ispravno
- Provjere curenja plina – provjerite sve spojeve s holender maticama i potvrdite da sustav ne propušta plin
- Provjerite jesu li svi ventili (visokotlačni i niskotlačni) u potpunosti otvoreni

7.2 Provjere vezane uz električnu sigurnost

Nakon ugradnje provjerite jesu li sve električne instalacije ugrađene u skladu s lokalnim i nacionalnim propisima te prema uputama iz priručnika za ugradnju.

Prije probnog rada

Provjera uzemljenja

Izmjerite otpor uzemljenja vizualnom detekcijom i instrumentom za mjerenje otpora uzemljenja. Otpor uzemljenja mora biti manji od 0,1. Napomena: Ovo ne mora biti obavezno za neke lokacije u Sjevernoj Americi.

Tijekom probnog rada

Provjera istjecanja struje

Tijekom probnog rada koristite ispitivač i multimeter da biste obavili sveobuhvatno ispitivanje istjecanja struje.

Ako se otkrije istjecanje električne energije, odmah isključite uređaj i kontaktirajte licenciranog električara da biste pronašli uzrok istjecanja i riješili ga.



Ovo ne mora biti obavezno za neke lokacije u Sjevernoj Americi.



Sve električne instalacije moraju biti u skladu s lokalnim i nacionalnim propisima za električne instalacije i mora ih postaviti licencirani električar.

7.3 Provjere curenja plina

Postoje dvije metode za provjeru curenja plina.

Način sa sapunom i vodom

Nanesite sapunastu vodu ili tekući deterdžent mekanim kistom na sve spojne točke cijevi unutarnje i vanjske jedinice. Nastanak mjehurića znači da plin curi.

Način s upotrebom detektora curenja

Ako koristite detektor curenja, pogledajte priručnik za uporabu uređaja da biste pročitali upute za pravilno korištenje.



Nakon što utvrdite da spojne točke cjevovoda ne propuštaju, vratite poklopac za ventil na vanjsku jedinicu.

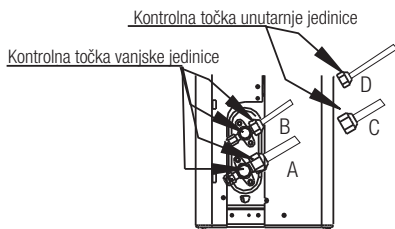

- A: Niskotlačni zaporni ventili
- B: Visokotlačni zaporni ventili
- C&D: Holender matice unutarnje jedinice

8 Probni rad

8.1 Upute za probni rad

Probni rad trebao bi trajati najmanje 30 minuta.

1. Spojite uređaj na napajanje.
2. Pritisnite gumb ON/OFF (UKLJUČENO/ ISKLJUČENO) na daljinskom upravljaču da biste ga uključili.
3. Pritisnite gumb MODE (NAČIN RADA) da biste prošli kroz sljedeće funkcije, jednu po jednu:
 - COOL (HLAĐENJE) – odaberite najnižu moguću temperaturu
 - HEAT (GRIJANJE) – odaberite najvišu moguću temperaturu
4. Pustite da uređaj radi u svakom načinu rada 5 minuta, a zatim obavite sljedeće provjere:

Popis provjera koje treba provesti	PROLAZ/PAD	
Nema istjecanja struje		
Jedinica je pravilno uzemljena		
Sve su električne redne stezaljke pravilno pokrivene		
Unutarnje i vanjske jedinice stabilno su ugrađene		
Spojne točke na cijevima ne propuštaju	Vanjska jedinica (2):	Unutarnja jedinica (2):
Voda se pravilno odvodi kroz odvodno crijevo		
Cjevovod je pravilno izoliran		
Jedinica pravilno izvodi funkciju COOL (HLAĐENJE)		
Jedinica pravilno izvodi funkciju HEAT (GRIJANJE)		
Lamele za usmjeravanje zraka na unutarnjoj jedinici se pravilno kreću		
Unutarnja jedinica reagira na signale daljinskog upravljača		



Tlak u rashladnom krugu povećat će se tijekom rada. Tako možete otkriti da neki spojevi propuštaju, a da to nije bilo primjetno prilikom provođenja prvog ispitivanja. Za vrijeme probnog rada provjerite po drugi put da spojne točke cijevi za rashladno sredstvo ne propuštaju. Pogledajte odjeljak Provjera propuštanja plina za daljnje upute.

5. Nakon uspješno obavljenog probnog rada, te nakon što potvrdite da su sve točke provjere na popisu provjera koje treba provesti PROŠLE, učinite sljedeće:

- Daljinskim upravljačem vratite uređaj na normalnu radnu temperaturu.
- Pomoću izolacijske trake omotajte spojeve cijevi za rashladno sredstvo unutarnje jedinice koje ste ostavili otkrivenima tijekom postupka ugradnje unutarnje jedinice.

Ako je temperatura okoline ispod 17°C (62°F)

Kada je temperatura u prostoriji niža od 17 °C daljinskim upravljačem ne možete uključiti funkciju Cool (Hlađenje). U tom slučaju možete koristiti gumb Manual Control (Ručno Upravljanje) za testiranje funkcije Cool (Hlađenje).

1. Dižite prednju ploču unutarnje jedinice dok ne čujete zvuk klika i dok ploča ne sjedne na svoje mjesto.
2. Gumb MANUAL CONTROL (RUČNO UPRAVLJANJE) nalazi se s desne strane uređaja. Pritisnite ga 2 puta da biste odabrali funkciju COOL (HLAĐENJE).
3. Dalje izvršite ispitivanje probnog rada na uobičajen način.

8 Probni rad

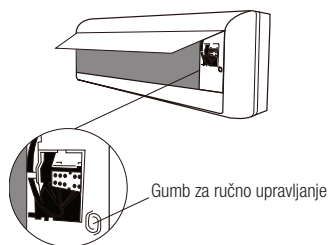

9 Njega i održavanje

9.1 Čišćenje unutarnje jedinice



OPREZ! Prije čišćenja ili održavanja klima uređaja, uvijek ga isključite i izvucite utikač iz utičnice.



Za čišćenje jedinice koristite samo mekanu, suhu krpu. Ako je jedinica jako zaprljana, možete koristiti krpu namočenu u toploj vodi da biste ju očistili.



OPREZ! Nemojte koristiti kemijska sredstva ili krpe natopljene kemijskim sredstvima za čišćenje klima uređaja.



OPREZ! Nemojte koristiti benzene, razrjeđivače, sredstva za poliranje ili druga otapala za čišćenje jedinice. Korištenje tih sredstava može uzrokovati nastanak deformacija ili pukotina na površini.



OPREZ! Nemojte koristiti vodu temperature iznad 40 °C (104 °F) za čišćenje prednje ploče. To može dovesti do nastanka deformacija ili gubitka boje na ploči.

9.2 Čišćenje filtra za zrak

Nakupljanje prljavštine u vašem klima uređaju možete smanjiti učinkovitost uređaja, a također može imati negativan utjecaj na vaše zdravlje. Filtre čistite svaka dva tjedna.

1. Podignite prednju ploču unutarnje jedinice.
2. Uхватite uložak filtra na kraju, podignite ga i povucite prema sebi.
3. Filtar izvucite van.
4. Ako vaš filter ima mali filter za osvježavanje zraka, odvojite ga od većeg filtra. Očistite filter za osvježavanje zraka pomoću ručnog usisivača.
5. Veliki filter za zrak očistite toplom, sapunastom vodom. Koristite blagi deterdžent.
6. Isperite filter svježom vodom i oteresite višak vode.
7. Osušite ga na hladnom, suhom mjestu i nemojte ga izlagati izravnoj sunčevoj svjetlosti.
8. Nakon što se osuši, filter za osvježavanje zraka spojite na veći filter te ih zajedno vratite nazad u unutarnju jedinicu.
9. Zatvorite prednju ploču unutarnje jedinice.

9 Njega i održavanje

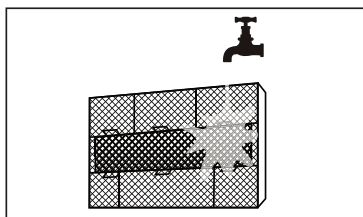
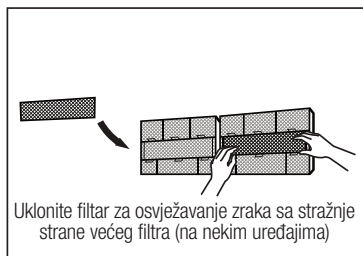
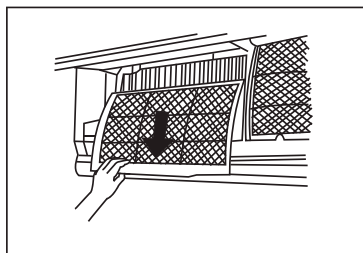
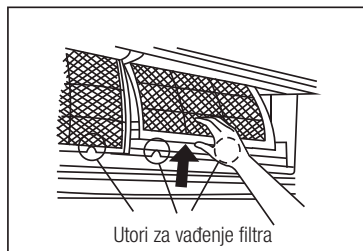

OPREZ! Nemojte dodirivati (plazma) filter za osvježavanje zraka najmanje 10 minuta nakon što isključite jedinicu.

OPREZ!

- Prije mijenjanja filtra ili čišćenja, isključite uređaj i izvucite utikač iz utičnice.
- Prilikom uklanjanja filtra, ne dodirujte metalne dijelove jedinice. Može doći do ozljeda zbog oštrih metalnih rubova.
- Nemojte koristiti vodu za čišćenje unutarnjeg dijela unutarnje jedinice. To može oštetiti izolaciju i prouzročiti strujni udar.
- Ne izlažite filter izravnom sunčevom svjetlu prilikom sušenja. To može deformirati, odnosno smanjiti filter.



9 Njega i održavanje

9.3 Održavanje – duga razdoblja nekorisćenja

Ako klima uređaj ne namjeravate koristiti dulje vrijeme, učinite sljedeće:

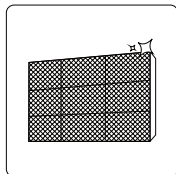

Očistite sve filtre



Uključite funkciju FAN (VENTILATOR) i pustite da uređaj tako radi dok se ne osuši u potpunosti



Isključite uređaj i izvucite utikač iz utičnice

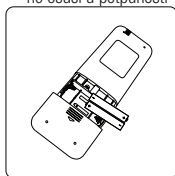

Izvadite baterije iz daljinskog upravljača

9.4 Održavanje – Provjera prije sezone

Nakon dugih razdoblja bez upotrebe ili prije razdoblja u kojima ćete uređaj često koristiti, učinite sljedeće:

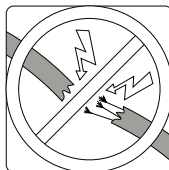

Provjerite ima li oštećenja na žicama

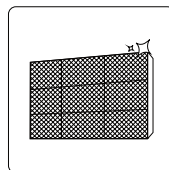

Očistite sve filtre



Provjerite nepropusnost cijevi

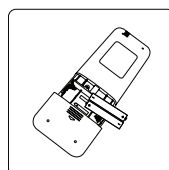

Zamijenite baterije



Provjerite blokira li nešto otvore za ulaz i izlaz zraka

10 Otklanjanje poteškoća



OPREZ! Odmah isključite uređaj u slučaju da dođe do bilo kojih od sljedećih situacija!

- Kabel za napajanje je oštećen ili neuobičajeno topao.
- Osjeća se miris paljenja/izgorjelog materijala.
- Uređaj proizvodi bučne ili neuobičajene zvukove.
- Osigurač pregori ili rastavna sklopka osigurača često iskače.
- Došlo je do prodora vode ili drugih predmeta u unutrašnjost uređaja ili je nešto ispalo iz njega.
- Ne pokušavajte popraviti to sami! Odmah kontaktirajte ovlašteni servis!

10.1 Uobičajeni problemi

Sljedeće poteškoće ne moraju nužno predstavljati kvar, a u većini slučajeva nema potrebe za popravkom.

Poteškoće	Mogući uzroci
Jedinica se ne uključuje pritiskom na gumb ON/OFF (UKLJUČENO/ISKLJUČENO)	Jedinica ima trominutnu zaštitnu značajku koja sprječava preopterećivanje uređaja. Uređaj se ne može ponovno pokrenuti unutar tri minute nakon što se ta značajka aktivirala.
Uređaj se prebacuje s načina rada COOL/HEAT (HLADENJE/GRIJANJE) na način rada FAN (VENTILATOR)	Uređaj može sam promijeniti svoju postavku da bi spriječio nastanak mraza na jedinici. Nakon što se temperatura povisi, uređaj će ponovno početi raditi u prethodno odabranom načinu rada.
	Postavljena temperatura je postignuta pa uređaj isključuje kompresor. Uređaj će nastaviti raditi kada se temperatura počne mijenjati.
Iz unutarnje jedinice izlazi bijela magla	Velika razlika u temperaturi zraka između zraka u prostoriji i klimatiziranog zraka može prouzročiti nastanak bijele magle u područjima s puno vlage.
Iz unutarnje, ali i vanjske jedinice izlazi bijela magla	Kada se jedinica ponovno pokrene u načinu rada HEAT (GRIJANJE) nakon odmrzavanja, može doći do pojave bijele maglice zbog vlage nastale kao posljedice postupka odmrzavanja.
Unutarnja jedinica proizvodi neuobičajene zvukove	Zvuk zviždanja zraka može se čuti tijekom ponovnog postavljanja lamela u svoj položaj.
	Zvuk škripanja može se čuti nakon postavljanja uređaja u način rada HEAT (GRIJANJE) zbog širenja i skupljanja plastičnih dijelova uređaja.
Unutarnja, ali i vanjska jedinica proizvode neuobičajene zvukove	Tih zvuk šištanja tijekom rada uređaja: to je uobičajeno, a zvuk nastaje zbog strujanja rashladnog sredstva kroz unutarnju i vanjsku jedinicu.
	Tih zvuk šištanja prilikom pokretanja, zaustavljanja ili odmrzavanja uređaja: taj je zvuk uobičajen, a nastaje zbog zaustavljanja ili promjene smjera rashladnog sredstva.
	Zvuk škripanja: uobičajeno širenje i skupljanje plastičnih i metalnih dijelova zbog promjena temperature tijekom rada može uzrokovati zvukove škripanja.

10 Otklanjanje poteškoća

Poteškoće	Mogući uzroci
Vanjska jedinica proizvodi neuobičajene zvukove	Jedinica će proizvoditi razne zvukove s obzirom na trenutni način rada.
Iz vanjske ili unutarnje jedinice izlazi prašina	Ako jedinica dulje vremena ne radi može doći do nakupljanja prašine koja će se izbaciti kada se uređaj uključi. Skupljanje prašine može se umanjiti prekrivanjem uređaja tijekom duljeg razdoblja nekorištenja.
Uređaj proizvodi neugodan miris	Jedinica može apsorbirati mirise iz okoliša (npr. miris namještaja, mirise kuhanja, cigareta, itd.) koji kasnije izlaze tijekom rada. Na filtrima jedinice se stvorila plijesan koja bi se trebala otkloniti.
Ventilator vanjske jedinice ne radi	Tijekom rada, brzinom ventilatora se upravlja kako bi se optimizirao rad proizvoda.
Uređaj ne funkcionira ispravno, ponaša se nepredvidivo ili ne reagira	Nepravilno funkcioniranje uređaja može biti uzrokovano smetnjama nastalim zbog odašiljača mobilnih operatora ili pojačivača signala. U tom slučaju, pokušajte sljedeće: <ul style="list-style-type: none">• Izvucite utikač uređaja iz utičnice, a zatim ga ponovno spojite.• Pritisnite gumb ON/OFF (UKLJUČENO/ISKLJUČENO) na daljinskom upravljaču da biste ponovno pokrenuli rad.



Ako problem ne prestaje, kontaktirajte lokalnog prodavača ili najbliži centar za korisnike. Detaljno im opišite kvar uređaja i recite broj vašeg modela.

10 Otklanjanje poteškoća

10.2 Otklanjanje poteškoća

U slučaju poteškoća, provjerite sljedeće stavke prije no što zatražite popravak jedinice.

Poteškoća	Mogući uzroci	Rješenje
Nedovoljno hlađenje	Možda je postavljena temperatura viša od temperature u prostoriji	Smanjite postavljenu temperaturu
	Izmjenjivač topline vanjske ili unutarnje jedinice je prljav	Očistite zaprljani izmjenjivač topline
	Filtar za zrak je prljav	Izvadite filtar i očistite ga u skladu s uputama
	Blokirani su otvori za ulaz ili izlaz zraka na bilo kojoj od jedinica	Isključite jedinicu, uklonite prepreku i ponovno uključite jedinicu
	Vrata i prozori su otvoreni	Držite vrata i prozore zatvorenim dok koristite uređaj
	Sunčeva svjetlost povećava temperaturu u prostoriji	Zatvorite prozore i zastore tijekom razdoblja kada je temperatura visoka ili kada je sunce jako žarko
	Previše izvora topline u prostoriji (ljudi, računala, električni uređaji, itd.)	Smanjite količinu izvora topline
	Mala količina rashladnog sredstva nastala zbog curenja ili dugog vremena upotrebe	Provjerite da ne dolazi do curenja rashladnog sredstva, prema potrebi zabrtvite sustav i dopunite rashladno sredstvo
	Aktivirana je (neobavezna) funkcija SILENCE (TIHI RAD)	Funkcija SILENCE (TIHI RAD) može smanjiti snagu uređaja na način da smanji radnu frekvenciju. Isključite funkciju SILENCE (TIHI RAD).

10 Otklanjanje poteškoća

Poteškoća	Mogući uzroci	Rješenje
Uređaj ne radi	Prekid napajanja	Pričekajte ponovnu uspostavu isporuke električne energije
	Isključeno napajanje	Uključite napajanje
	Pregorjeli osigurač	Zamijenite osigurač
	Prazne baterije daljinskog upravljača	Zamijenite baterije
	Aktivirana je trominutna zaštita uređaja	Pričekajte tri minute i ponovno pokrenite uređaj
	Brojač vremena je aktiviran	Isključite brojač vremena
Uređaj se često pokreće i zaustavlja	Premalo rashladnog sredstva u sustavu	Provjerite da ne dolazi do curenja i dopunite sustav rashladnim sredstvom.
	U sustav je ušao nestlačiv plin ili vlaga.	Ispustite rashladno sredstvo i napunite sustav novim rashladnim sredstvom
	Neispravan kompresor	Zamijenite kompresor
	Previsoki ili preniski napon	Ugradite manostat za regulaciju napona
Nedovoljno grijanje	Vanjska je temperatura iznimno niska	Koristite pomoćni uređaj za grijanje
	Hladan zrak ulazi kroz vrata i prozore	Držite vrata i prozore zatvorenim dok koristite uređaj
	Mala količina rashladnog sredstva nastala zbog curenja ili dugog vremena upotrebe	Provjerite da ne dolazi do curenja rashladnog sredstva, prema potrebi zabrtvite sustav i dopunite rashladno sredstvo
Indikatorske žaruljice neprestano trepere	<p>Uređaj može stati s radom ili nastaviti radi sigurno. Ako indikatorske žaruljice nastave treperiti ili se pojave šifre greške, pričekajte otprilike 10 minuta. Moguće je da će se poteškoća riješiti sama od sebe. Ako to nije slučaj, izvucite utikač iz utičnice i ponovno ga spojite. Uključite uređaj. Ako poteškoća ne prestaje, izvucite utikač iz utičnice i kontaktirajte najbliži centar za korisnike.</p>	
Pojavljuje se kod pogreške, i počinje slovima kao što su sljedeća u prozoru zaslonu unutarnje jedinice: E(x), P(x), F(x) EH(xx), EL(xx), EC(xx), PH(xx), PL(xx), PC(xx)		

10 Otklanjanje poteškoća



Ako problem ne prestaje niti nakon gore opisanih pregleda i dijagnostike, odmah isključite uređaj i kontaktirajte najbliži centar za korisnike.

11 Europske smjernice za odlaganje

Ovaj uređaj sadržava rashladno sredstvo i ostale potencijalno opasne materijale. Prilikom odlaganja ovog uređaja, zakon zahtijeva posebno prikupljanje i tretman, **Nemojte** odlagati proizvod kao kućni otpad ili nerazvrstani komunalni otpad,

Prilikom odlaganja ovog uređaja, imate sljedeće mogućnosti:

- odlaganje uređaja u određenom objektu za prikupljanje komunalnog elektroničkog otpada.
- prilikom kupovine novog uređaja, prodavač će preuzeti stari uređaj bez dodatne naknade.
- proizvođač će preuzeti stari uređaj bez dodatne naknade.
- prodajte uređaj ovlaštenom trgovcu za otpadni metal.

Ovaj simbol označava da se uređaj ne smije odlagati s ostalim kućnim otpadom na kraju radnog vijeka. Korišteni uređaj mora se vratiti na službeno mjesto za recikliranje električnih i elektroničkih uređaja. Da biste pronašli ove sustave sakupljanja otpada, obratite se lokalnim vlastima ili prodavatelju kod kojeg je proizvod kupljen. Svako kućanstvo ima važnu ulogu u sanaciji i recikliranju starih uređaja. Primjereno odlaganje korištenih uređaja pomaže u sprečavanju mogućih negativnih utjecaja na okoliš i ljudsko zdravlje.



Posebna napomena

Odlaganje uređaja u šumi ili drugom prirodnom okruženju ugrožava vaše zdravlje i loše je za okoliš. Opasne tvari mogu iscuriti u podzemnu vodu i ući u prehrambeni lanac.



12 Upute za ugradnju

12.1 Upute za F-plin

Ovaj proizvod sadržava fluorirane stakleničke plinove.

Fluorirani staklenički plinovi sadržani su u hermetički zatvorenoj opremi.

Ugradnju, servis, održavanje, popravke, provjere mogućnosti curenja ili stavljanje opreme izvan pogona i recikliranje proizvoda trebaju obavljati fizičke osobe koje posjeduju relevantne certifikate.

Ako sustav ima ugrađen sustav za otkrivanje curenja, provjere curenja bi se trebale obavljati barem svakih 12 mjeseci kako bi se osiguralo pravilno funkcioniranje sustava.

Ako je na proizvodu potrebno obaviti provjere curenja, trebalo bi navesti koliko često se provjere trebaju obavljati te izraditi i spremiti evidenciju o provjerama curenja.



Napomena: Za hermetički zatvorenu opremu, lokalni klima uređaj, prozorske klima uređaje i odvlaživače, ako je CO₂ ekvivalent fluoriranih stakleničkih plinova manji od 10 tona, ne treba izvesti provjeru curenja.

13 Specifikacije

BEEPI

Naziv modela	Unutarnja jedinica	BEEPI 090	BEEPI 120
	Vanjska jedinica	BEEPI 091	BEEPI 121
Rashladno sredstvo		R32	R32
Ukupna količina rashladnog sredstva (g)		620	620
GWP (potencijal globalnog zatopljenja)		675	675
Ekvivalent CO2 (tone)		0,419	0,419
Anti-električno		Klasa I	Klasa I
Klimatski razred		T1	T1
Vrsta grijanja		Toplinska pumpa	Toplinska pumpa
Priključak za električno napajanje		Vanjska strana zida	Vanjska strana zida
Pdizajin C (kW)		2,5	3,2
Pdizajin H (kW)		2,4 (EU prosječna sezona)	2,4 (EU prosječna sezona)
Vrijednosti SEER/AEER/ponderirani EER (W/W)		9,0 (SEER, EU)	8,5 (SEER, EU)
Vrijednosti SCOP/ACOP/ponderirani EER (W/W)		4,6 (SCOP, EU prosjek)	4,6 (SCOP, EU prosjek)
Energetska razina – hlađenje		A+++ (EU)	A+++ (EU)
Energetska razina – grijanje		A++ (EU Prosječna sezona)	A++ (EU Prosječna sezona)
Godišnja potrošnja energije – hlađenje (kWh)		98	132
Godišnja potrošnja energije – grijanje (kWh)		743	743
Deklarirani kapacitet za izračun vrijednosti SCOP u referentnim uvjetima (kW)		2,1	2,1
Rezervni kapacitet grijanja koji se pretpostavlja za izračun vrijednosti SCOP pri referentnim projektnim uvjetima (kW)		0,3	0,3
Snaga električnog grijača (W)		/	/
Ulazna snaga hlađenja (W)		/	/
Ulazna snaga grijanja (W)		/	/
Napon/frekvencija (V/Hz)		220-240V~ 50Hz, 1Ph	220-240V~ 50Hz, 1Ph
Jakost struje hlađenja (A)		/	/
Jakost struje grijanja (A)		/	/
Razina tlaka buke – Unutarnja jedinica (dBA)		37/33/23/20	39/35/24/21
Razina tlaka buke – Vanjska jedinica (dBA)		54,0	54,5
Volumen protoka zraka (m3/h)		483/362/303	584/477/395
Nazivna ulazna snaga – EN 60335(W)		2200	2200
Nazivna ulazna struja – EN 60335(A)		10,5	10,5
Klasa otpora unutarnje jedinice		IPX0	IPX0

13 Specifikacije

Naziv modela	Unutarnja jedinica	BEEPI 090	BEEPI 120
	Vanjska jedinica	BEEPI 091	BEEPI 121
Klasa otpora vanjske jedinice		IP24	IP24
Promjer visokotlačnih cijevi (mm)		Φ6,35 (1/4")	Φ6,35 (1/4")
Promjer niskotlačnih cijevi (mm)		Φ9,52 (3/8")	Φ9,52 (3/8")
Specifikacija kabela za napajanje (mm ²)		3G2,5	3G2,5
Unutarnji i vanjski spojni kabel (mm ²)		5G1,5	5G1,5
Maks.podizanje (m)		10	10
Maks.duljina cijevi (m)		25	25
Dodatna količina plina (g/m)		12	12
Unutarnja jedinica (WxHxD) mm		832 x 297 x 223	832 x 297 x 223
Vanjska jedinica (WxHxD) mm		765 x 555 x 303	765 x 555 x 303
Neto težina unutarnje jedinice (kg)		9,5	9,5
Neto težina vanjske jedinice (kg)		27,0	27,0

Napomena:

1. Specifikacije su standardne vrijednosti izračunate na temelju nazivnih radnih uvjeta. Razlikovat će se u različitim radnim uvjetima.
 2. Naša tvrtka ima brza tehnička poboljšanja. Za bilo koju promjenu tehničkih podataka poslat ćemo prethodnu obavijest. Pročitajte pločicu s podacima na klima uređaju.
- Pogledajte detaljne obavezne informacije o proizvodu u Uredbi br.206/2012 iz brošure o proizvodu.

13 Specifikacije

BEHPI

Naziv modela	Unutarnja jedinica	BEHPI 090	BEHPI 120	BEHPI 180	BEHPI 240
	Vanjska jedinica	BEHPI 091	BEHPI 121	BEHPI 181	BEHPI 241
Rashladno sredstvo		R32	R32	R32	R32
Ukupna količina rashladnog sredstva (g)		550	550	1100	1450
GWP (potencijal globalnog zatopljenja)		675	675	675	675
Ekvivalent CO2 (tone)		0,371	0,371	0,743	0,979
Anti-električno		Klasa I	Klasa I	Klasa I	Klasa I
Klimatski razred		T1	T1	T1	T1
Vrsta grijanja		Toplinska pumpa	Toplinska pumpa	Toplinska pumpa	Toplinska pumpa
Priključak za električno napajanje		Vanjska strana zida	Vanjska strana zida	Vanjska strana zida	Vanjska strana zida
Pdizajn C (kW)		2,7	3,5	5,2	7,0
Pdizajn H (kW)		2,7 (EU prosječna sezona)	2,9 (EU prosječna sezona)	4,1 (EU prosječna sezona)	4,9 (EU prosječna sezona)
Vrijednosti SEER/AEER/ponderirani EER (W/W)		6,9 (SEER, EU)	7,0 (SEER, EU)	7,0 (SEER, EU)	6,5 (SEER, EU)
Vrijednosti SCOP/ACOP/ponderirani EER (W/W)		4,0 (SCOP, EU prosjek)	4,0 (SCOP, EU prosjek)	4,0 (SCOP, EU prosjek)	4,0 (SCOP, EU prosjek)
Energetska razina – hlađenje		A++ (EU)	A++ (EU)	A++ (EU)	A++ (EU)
Energetska razina – grijanje		A+ (EU Prosječna sezona)	A+ (EU Prosječna sezona)	A+ (EU Prosječna sezona)	A+ (EU Prosječna sezona)
Godišnja potrošnja energije – hlađenje (kWh)		137	175	260	377
Godišnja potrošnja energije – grijanje (kWh)		945	990	1435	1730
Deklarirani kapacitet za izračun vrijednosti SCOP u referentnim projektnim uvjetima (kW)		2,6	2,7	3,4	3,7
Rezervni kapacitet grijanja koji se pretpostavlja za izračun vrijednosti SCOP pri referentnim projektnim uvjetima (kW)		0,1	0,2	0,7	1,2
Snaga električnog grijača (W)		/	/	/	/
Ulazna snaga hlađenja (W)		/	/	/	/
Ulazna snaga grijanja (W)		/	/	/	/
Napon/frekvencija (V/Hz)		220-240V~ 50Hz, 1Ph	220-240V~ 50Hz, 1Ph	220-240V~ 50Hz, 1Ph	220-240V~ 50Hz, 1Ph
Jakost struje hlađenja (A)		/	/	/	/

13 Specifikacije

Naziv modela	Unutarnja jedinica	BEHPI 090	BEHPI 120	BEHPI 180	BEHPI 240
	Vanjska jedinica	BEHPI 091	BEHPI 121	BEHPI 181	BEHPI 241
Jakost struje grijanja (A)		/	/	/	/
Razina tlaka buke – Unutarnja jedinica (dBA)		56	55	57	63
Razina tlaka buke – Vanjska jedinica (dBA)		63	63	65	67
Volumen protoka zraka (m3/h)		416/309/230	584/477/395	730/500/420	1020/830/640
Nazivna ulazna snaga – EN 60335(W)		2150	2150	2500	3700
Nazivna ulazna struja – EN 60335(A)		10	10	13	19
Klasa otpora unutarnje jedinice		IPX0	IPX0	IPX0	IPX0
Klasa otpora vanjske jedinice		IP24	IP24	IP24	IP24
Promjer visokotlačnih cijevi (mm)		6,35 mm (1/4 inča)	6,35 mm (1/4 inča)	6,35 mm (1/4 inča)	9,52 mm (3/8 inča)
Promjer niskotlačnih cijevi (mm)		9,52 mm (3/8 inča)	9,52 mm (3/8 inča)	12,7 mm (1/2 inča)	15,9 mm (5/8 inča)
Specifikacija kabela za napajanje (mm ²)		1,5 x 3	1,5 x 3	1,5 x 3	2,5 x 3
Unutarnji i vanjski spojnik kabel (mm ²)		1,5 x 5	1,5 x 5	1,5 x 5	2,5 x 5
Maks.podizanje (m)		10	10	20	25
Maks duljina cijevi (m)		25	25	30	50
Dodatna količina plina (g/m)		12	12	12	24
Unutarnja jedinica (WxHxD) mm		752 x 290 x 219	832 x 297 x 223	995 x 319 x 251	1119 x 336 x 259
Vanjska jedinica (WxHxD) mm		720 x 495 x 270	720 x 495 x 270	805 x 554 x 330	890 x 673 x 342
Neto težina unutarnje jedinice (kg)		8,5	9,5	12	15
Neto težina vanjske jedinice (kg)		23	23	32	43

Napomena:

1. Specifikacije su standardne vrijednosti izračunate na temelju nazivnih radnih uvjeta. Razlikovat će se u različitim radnim uvjetima.
 2. Naša tvrtka ima brza tehnička poboljšanja. Za bilo koju promjenu tehničkih podataka poslat ćemo prethodnu obavijest. Pročitajte pločicu s podacima na klima uređaju.
- Pogledajte detaljne obavezne informacije o proizvodu u Uredbi br.206/2012 iz brošure o proizvodu.

13 Specifikacije

BEVPI

Naziv modela	Unutarnja jedinica	BEVPI 090	BEVPI 120	BEVPI 180	BEVPI 240
	Vanjska jedinica	BEVPI 091	BEVPI 121	BEVPI 181	BEVPI 241
Rashladno sredstvo		R32	R32	R32	R32
Ukupna količina rashladnog sredstva (g)		550	550	1100	1450
GWP (potencijal globalnog zatopljenja)		675	675	675	675
Ekvivalent CO2 (tone)		0,371	0,371	0,743	0,979
Anti-električno		Klasa I	Klasa I	Klasa I	Klasa I
Klimatski razred		T1	T1	T1	T1
Vrsta grijanja		Toplinska pumpa	Toplinska pumpa	Toplinska pumpa	Toplinska pumpa
Priključak za električno napajanje		Vanjska strana zida	Vanjska strana zida	Vanjska strana zida	Vanjska strana zida
Pdizajn C (kW)		2,7	3,5	5,2	7,0
Pdizajn H (kW)		2,7 (EU prosječna sezona)	2,9 (EU prosječna sezona)	4,1 (EU prosječna sezona)	4,9 (EU prosječna sezona)
Vrijednosti SEER/AEER/ponderirani EER (W/W)		6,9 (SEER, EU)	7,0 (SEER, EU)	7,0 (SEER, EU)	6,5 (SEER, EU)
Vrijednosti SCOP/ACOP/ponderirani EER (W/W)		4,0 (SCOP, EU prosjek)	4,0 (SCOP, EU prosjek)	4,0 (SCOP, EU prosjek)	4,0 (SCOP, EU prosjek)
Energetska razina – hlađenje		A++ (EU)	A++ (EU)	A++ (EU)	A++ (EU)
Energetska razina – grijanje		A+ (EU Prosječna sezona)	A+ (EU Prosječna sezona)	A+ (EU Prosječna sezona)	A+ (EU Prosječna sezona)
Godišnja potrošnja energije – hlađenje (kWh)		137	175	260	377
Godišnja potrošnja energije – grijanje (kWh)		945	990	1435	1730
Deklarirani kapacitet za izračun vrijednosti SCOP u referentnim projektnim uvjetima (kW)		2,6	2,7	3,4	3,7
Rezervni kapacitet grijanja koji se pretpostavlja za izračun vrijednosti SCOP pri referentnim projektnim uvjetima (kW)		0,1	0,2	0,7	1,2
Snaga električnog grijača (W)		/	/	/	/
Ulazna snaga hlađenja (W)		/	/	/	/
Ulazna snaga grijanja (W)		/	/	/	/
Napon/frekvencija (V/Hz)		220-240V~ 50Hz, 1Ph	220-240V~ 50Hz, 1Ph	220-240V~ 50Hz, 1Ph	220-240V~ 50Hz, 1Ph
Jakost struje hlađenja (A)		/	/	/	/

13 Specifikacije

Naziv modela	Unutarnja jedinica	BEVPI 090	BEVPI 120	BEVPI 180	BEVPI 240
	Vanjska jedinica	BEVPI 091	BEVPI 121	BEVPI 181	BEVPI 241
Jakost struje grijanja (A)		/	/	/	/
Razina tlaka buke – Unutarnja jedinica (dBA)		56	55	57	63
Razina tlaka buke – Vanjska jedinica (dBA)		63	63	65	67
Volumen protoka zraka (m3/h)		416/309/230	584/477/395	730/500/420	1020/830/640
Nazivna ulazna snaga – EN 60335(W)		2150	2150	2500	3700
Nazivna ulazna struja – EN 60335(A)		10	10	13	19
Klasa otpora unutarnje jedinice		IPX0	IPX0	IPX0	IPX0
Klasa otpora vanjske jedinice		IP24	IP24	IP24	IP24
Promjer visokotlačnih cijevi (mm)		6,35 mm (1/4 inča)	6,35 mm (1/4 inča)	6,35 mm (1/4 inča)	9,52 mm (3/8 inča)
Promjer niskotlačnih cijevi (mm)		9,52 mm (3/8 inča)	9,52 mm (3/8 inča)	12,7 mm (1/2 inča)	15,9 mm (5/8 inča)
Specifikacija kabela za napajanje (mm ²)		1,5 x 3	1,5 x 3	1,5 x 3	2,5 x 3
Unutarnji i vanjski spojnik kabel (mm ²)		1,5 x 5	1,5 x 5	1,5 x 5	2,5 x 5
Maks.podizanje (m)		10	10	20	25
Maks duljina cijevi (m)		25	25	30	50
Dodatna količina plina (g/m)		12	12	12	24
Unutarnja jedinica (WxHxD) mm		752 x 290 x 219	832 x 297 x 223	995 x 319 x 251	1119 x 336 x 259
Vanjska jedinica (WxHxD) mm		720 x 495 x 270	720 x 495 x 270	805 x 554 x 330	890 x 673 x 342
Neto težina unutarnje jedinice (kg)		8,5	9,5	12	15
Neto težina vanjske jedinice (kg)		23	23	32	43

Napomena:

1. Specifikacije su standardne vrijednosti izračunate na temelju nazivnih radnih uvjeta. Razlikovat će se u različitim radnim uvjetima.
 2. Naša tvrtka ima brza tehnička poboljšanja. Za bilo koju promjenu tehničkih podataka poslat ćemo prethodnu obavijest. Pročitajte pločicu s podacima na klima uređaju.
- Pogledajte detaljne obavezne informacije o proizvodu u Uredbi br.206/2012 iz brošure o proizvodu.

Arçelik A.Ş. Karaağaç Caddesi No:2-6
34445, S tl ce, İstanbul, T rkiye
www.beko.com