

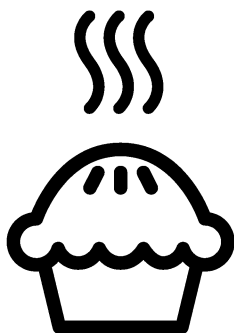

**Built-in Oven**  
User Manual



BID15501XDS

**EN**

285.4463.92/R.AE/15.05.2020/6-1  
7757882937

# Please read this user manual first!

Dear Customer,

Thank you for purchasing this Beko product. We hope that you get the best results from your product which has been manufactured with high quality and state-of-the-art technology. Therefore, please read this entire user manual and all other accompanying documents carefully before using the product and keep it as a reference for future use. If you handover the product to someone else, give the user manual as well. Follow all warnings and information in the user manual.

Remember that this user manual is also applicable for several other models.

Differences between models will be identified in the manual.

## Explanation of symbols

Throughout this user manual the following symbols are used:



Important information or useful hints about usage.



Warning of hazardous situations with regard to life and property.



Warning of electric shock.



Warning of risk of fire.



Warning of hot surfaces.



**Arçelik A.Ş.**  
Karaağaç caddesi No:2-6  
34445 Söğütözü/İstanbul/TURKEY

Made in TURKEY

This product was manufactured using the latest technology in environmentally friendly conditions.

# TABLE OF CONTENTS

## **1 Important instructions and warnings for safety and environment 4**

General safety .....	4
Electrical safety.....	5
Product safety .....	6
Intended use .....	9
Safety for children.....	9
Disposing of the old product .....	10
Package information .....	10

## **2 General information 11**

Overview .....	11
Package contents.....	13
Technical specifications .....	15

## **3 Installation 16**

Before installation .....	16
Installation and connection .....	18
Future Transportation.....	20

## **4 Preparation 21**

Tips for saving energy .....	21
Initial use .....	21
Time setting.....	21
First cleaning of the appliance .....	22
Adjust the water hardness level .....	22
Initial heating .....	23

## **5 How to operate the oven 25**

General information on baking, roasting and grilling.....	25
How to operate the electric oven .....	26
Operating modes.....	26
Control panel introduction .....	30
Cooking Programs Menu.....	30
Automatic Cooking Functions Menu .....	35
Extra Programs Menu .....	38
Settings Menu .....	45
Cooking times table .....	46
How to operate the grill .....	48
Cooking times table for grilling.....	52

## **6 Maintenance and care 53**

General information.....	53
Cleaning the control panel.....	53
Cleaning the oven .....	54
Removing the oven door .....	54
Replacing the oven lamp .....	55

## **7 Troubleshooting 56**

## **1 Important instructions and warnings for safety and environment**

This section contains safety instructions that will help protect from risk of personal injury or property damage. Failure to follow these instructions shall void any warranty.

### **General safety**

- This appliance can be used by children aged from 8 years and above and persons with reduced physical, sensory or mental capabilities or lack of experience and knowledge if they have been given supervision or instruction concerning use of the appliance in a safe way and understand the hazards involved.

Children shall not play with the appliance. Cleaning and user maintenance shall not be made by children without supervision.

- The appliance is not to be used by persons (including children) with reduced physical, sensory or mental capabilities, or lack of experience and knowledge,

unless they have been given supervision or instruction.

Children should be supervised and ensure they do not play with the appliance

- If the product is handed over to someone else for personal use or second-hand use purposes, the user manual, product labels and other relevant documents and parts should be also given.
- Installation and repair procedures must always be performed by Authorised Service Agents. The manufacturer shall not be held responsible for damages arising from procedures carried out by unauthorised persons which may also void the warranty. Before installation, read the instructions carefully.
- Do not operate the product if it is defective or has any visible damage.
- Ensure that the product function knobs are switched off after every use.

## Electrical safety

- If the product has a failure, it should not be operated unless it is repaired by an Authorised Service Agent. There is the risk of electric shock!
- Only connect the product to a grounded outlet/line with the voltage and protection as specified in the “Technical specifications”. Have the grounding installation made by a qualified electrician while using the product with or without a transformer. Our company shall not be liable for any problems arising due to the product not being earthed in accordance with the local regulations.
- Never wash the product by spreading or pouring water onto it! There is the risk of electric shock!
- Never touch the plug with wet hands! Never unplug by pulling on the cable, always pull out by holding the plug.
- The product must be disconnected during installation, maintenance, cleaning and repairing procedures.
- If the power connection cable for the product is damaged, it must be replaced by the manufacturer, its service agent or similarly qualified persons in order to avoid a hazard.
- The appliance must be installed so that it can be completely disconnected from the mains supply. The separation must be provided by a switch built into the fixed electrical installation, according to construction regulations.
- Rear surface of the oven gets hot when it is in use. Make sure that the electrical connection does not contact with the rear surface; otherwise, connections can get damaged.
- Do not trap the mains cable between the oven door and frame and do not route it over hot surfaces. Otherwise, cable insulation may melt and cause fire as a result of short circuit.
- Any work on electrical equipment and systems should only be carried out by authorised and qualified persons.

- In case of any damage, switch off the product and disconnect it from the mains. To do this, turn off the fuse at home.
- Make sure that fuse rating is compatible with the product.

### **Product safety**

- **WARNING:** The appliance and its accessible parts become hot during use. Care should be taken to avoid touching heating elements. Children less than 8 years of age shall be kept away unless continuously supervised.
- Never use the product when your judgment or coordination is impaired by the use of alcohol and/or drugs.
- Be careful when using alcoholic drinks in your dishes. Alcohol evaporates at high temperatures and may cause fire since it can ignite when it comes into contact with hot surfaces.
- Food Poisoning Hazard: Do not let food sit in oven for more than 1 hour before or after cooking. Doing so can result in food poisoning or sickness.
- Do not place any flammable materials close to the product as the sides may become hot during use.
- During use the appliances becomes hot. Care should be taken to avoid touching heating elements inside the oven.
- Keep all ventilation slots clear of obstructions.
- Do not heat closed tins and glass jars in the oven. The pressure that would build-up in the tin/jar may cause it to burst.
- Do not place baking trays, dishes or aluminium foil directly onto the bottom of the oven. The heat accumulation might damage the bottom of the oven.
- Do not use harsh abrasive cleaners or sharp metal scrapers to clean the oven door glass since they can scratch the surface, which may result in shattering of the glass.
- Do not use steam cleaners to clean the appliance as this may cause an electric shock.

- (Varies depending on the product model.)

Placing the wire shelf and tray onto the wire racks properly

It is important to place the wire shelf and/or tray onto the rack properly. Slide the wire shelf or tray between 2 rails and make sure that it is balanced before placing food on it (Please see the following figure).

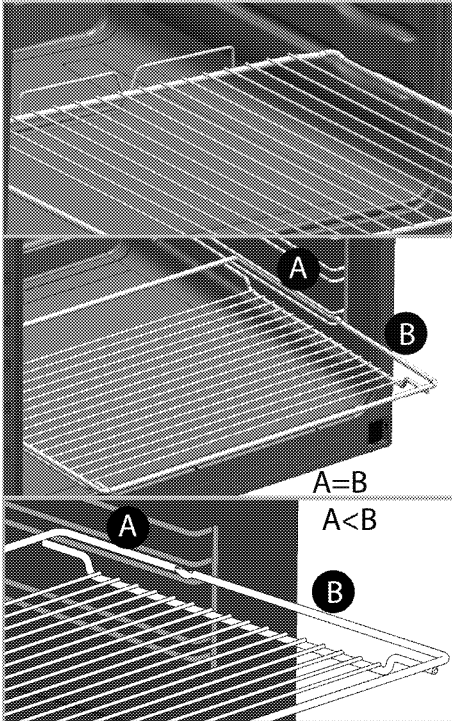

- Do not use the product if the front door glass is removed or cracked.

- Always use heat resistant oven gloves when putting in or removing dishes into/from the hot oven.
- Place the baking paper into the cooking pot or on to the oven accessory (tray, wire grill etc) together with the food and then insert all into the preheated oven. Remove the excess parts of the baking paper overflowing from the accessory or the pot in order to prevent the risk of touching the oven's heating elements. Never use the baking paper in an operating temperature higher than the indicated value for the baking paper. Do not place the baking paper directly on the base of the oven.
- **WARNING:** Ensure that power cord of the appliance is unplugged or circuit breaker is switched off before replacing the lamp to avoid the possibility of electric shock.
- (If your product is equipped with self-cleaning function/feature) Before the cleaning cycle, remove dirt from exterior surfaces and oven interior with a damp

cloth. Remove all accessories inside of oven.

If your product is equipped with a pyro proof accessory (Resilient against self-cleaning at high temperatures), you do not need to remove these accessories from the oven.

*see Package contents, page 13.*

- **(If your product is equipped with self-cleaning function/feature)** Hot surfaces cause burns! Do not touch the product during self cleaning step and keep children away from it. Wait at least 30 minutes before removing the remnants.
- **(If your product is equipped with self-cleaning function/feature)** During pyrolytic cleaning, surfaces may become hotter than with standard use. Keep children away.
- The appliance must not be installed behind a decorative door in order to avoid overheating.

**For the steam system:**

- With steam cooking, steam may come out if you open the door of the product. This may result in risk of burning.

Be careful when opening the door.

- Do not pour water into the oven. Otherwise, hot steam may be observed.
- Humidity remaining inside the oven after steam cooking may lead to corrosion. After cooking, wait for the inside of the oven to dry. Do not preserve wet foods inside the oven for a long time.
- Do not cook anything if there is water in the oven. Inner surfaces of the oven may get damaged.
- With steam cooking, do not use utensils that may become rusty.
- Do not use distilled or filtered water. Use bottled water only. Do not add solutions that are inflammable, contain alcohol or solid particles into the water container.
- Never dry the water container in the oven.
- After each steam cooking, discharge the remaining water in the water container and clean it. Using the water remaining in the water container for the next cooking cycle will lead to problems in terms of hygiene.



- The water container must be dried and stored dry.
- Do not wash the water container in the dishwasher. Wipe it with a clean and damp cloth, and then dry it with a dry cloth.
- For descaling, use the descaling tablets provided by the manufacturer. (You can also use commercially available descalers, which are recommended for steam assisted cooking appliances, in accordance with their instructions for use.)

Prevention against possible fire risk!

- Ensure all electrical connections are secure and tight to prevent risk of arcing.
- Do not use damaged cables or extension cables.
- Ensure liquid or moisture is not accessible to the electrical connection point.

### **Intended use**

- This product is designed for domestic use. Commercial use will void the guarantee.
- **CAUTION:** This appliance is for cooking purposes only. It must not be used for other

purposes, for example room heating.

- This product should not be used for warming the plates under the grill, drying towels, dish cloths etc. by hanging them on the oven door handles. This product should also not be used for room heating purposes.
- The manufacturer shall not be liable for any damage caused by improper use or handling errors.
- The oven can be used for defrosting, baking, roasting and grilling food.

### **Safety for children**

- **WARNING:** Accessible parts may become hot during use. Young children should be kept away.
- The packaging materials will be dangerous for children. Keep the packaging materials away from children. Please dispose of all parts of the packaging according to environmental standards.
- Electrical products are dangerous to children. Keep children away from the product when it is operating

and do not allow them to play with the product.

- Do not place any items above the appliance that children may reach for.
- When the door is open, do not load any heavy object on it and do not allow children to sit on it. It may overturn or door hinges may get damaged.

## **Disposing of the old product**

### **Compliance with the WEEE Directive and Disposing of the Waste Product:**



This product complies with EU WEEE Directive (2012/19/EU). This product bears a classification symbol for waste electrical and electronic equipment (WEEE).

This product has been manufactured with high quality parts and materials which can be reused and are suitable for recycling. Do not dispose of the waste product with normal domestic and other wastes at the end of its service life. Take it to the collection center for the recycling of electrical and electronic equipment. Please consult your local authorities to learn about these collection centers.

### **Compliance with RoHS Directive:**

The product you have purchased complies with EU RoHS Directive (2011/65/EU). It does not contain harmful and prohibited materials specified in the Directive.

### **Package information**

- Packaging materials of the product are manufactured from recyclable materials in accordance with our National Environment Regulations. Do not dispose of the packaging materials together with the domestic or other wastes. Take them to the packaging material collection points designated by the local authorities.

## 2 General information

### Overview

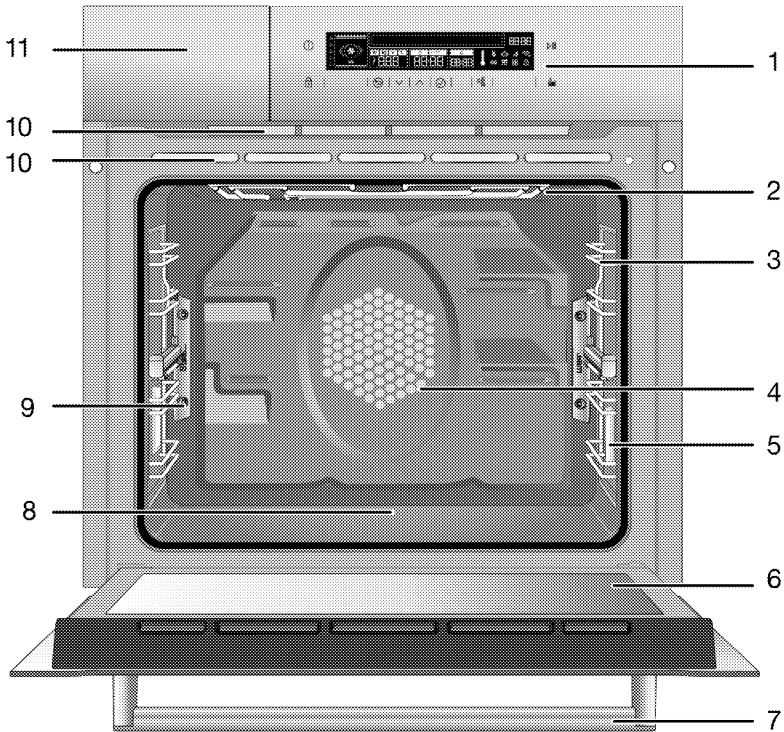

- |                                  |  |
|----------------------------------|--|
| 1 Control panel                  | 8 Bottom heater (bottom steel plate)   |
| 2 Top heating element            | 9 Vapour exit holes  |
| 3 Shelf positions                | 10 Integral air grille   |
| 4 Fan motor (behind steel plate) | 11 Water container cover (In some models, the cover of water container will open frontways.) |
| 5 Lamp                           |  |
| 6 Front door                     |  |
| 7 Handle                         |  |

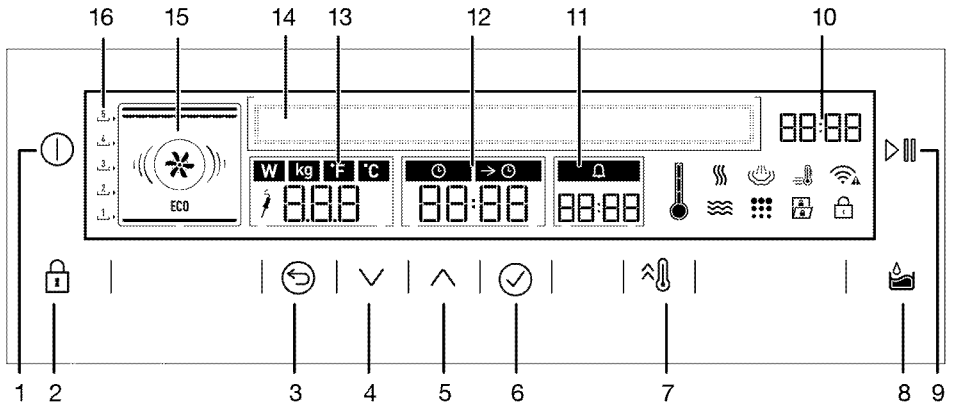

- 1 ON/OFF key
- 2 Key lock key
- 3 Back key
- 4 Down key (Menu Selection)
- 5 Up key (Menu Selection)
- 6 OK key
- 7 Rapid heating key
- 8 Water container cover release key
- 9 Start/stop cooking key
- 10 Current time indicator field
- 11 Alarm time field
- 12 Cooking time/cooking end time field
- 13 Temperature/weight indicator field
- 14 Text display
- 15 Function display
- 16 Shelf positions

## Package contents

**i** Accessories supplied can vary depending on the product model. Not every accessory described in the user manual may exist on your product.

### 1. User manual

### 2. Standard tray

**(Pyro proof - Resilient against self-cleaning at high temperatures)**

Used for pastries, frozen foods and big roasts.

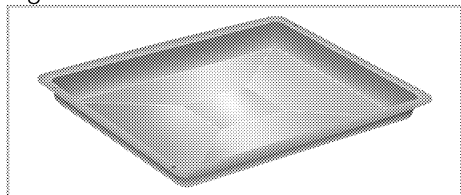

### 3. Deep tray

**(Pyro proof - Resilient against self-cleaning at high temperatures)**

Used for pastries, large roasts, juicy dishes, and for collecting the fat while grilling.

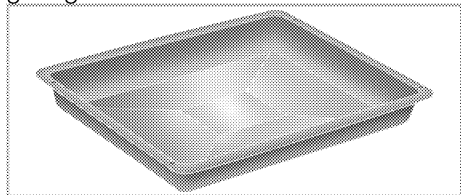

### 4. Pastry tray

**(Pyro proof - Resilient against self-cleaning at high temperatures)**

Used for pastries such as cookies and biscuits.

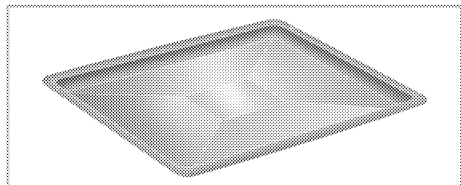

### 5. Wire grill

Used for roasting and for placing the food to be baked, roasted or cooked in casserole dishes to the desired rack.

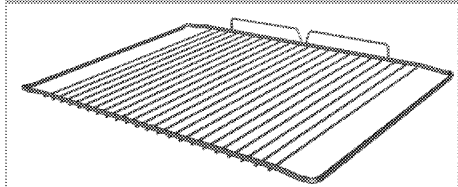
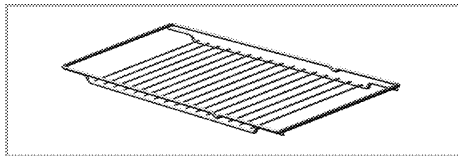

### 6. Placing the wire shelf and tray onto the telescopic racks properly (This feature is optional. It may not exist on your product.)

Telescopic racks allow you to install and remove the trays and wire shelf easily.

When using the tray and wire shelf with telescopic racks, make sure that the pins at the rear section of the telescopic rack stands against the edges of the wire shelf and tray.

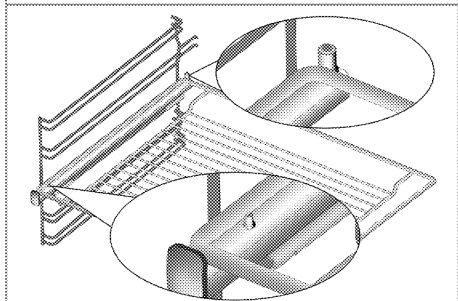
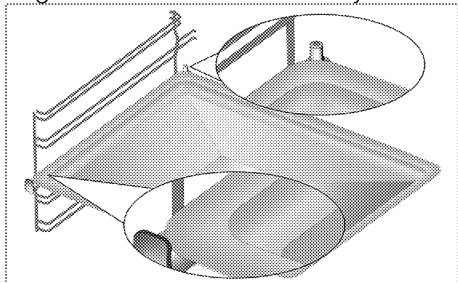

### 7. Perforated large tray for steam cooking

Suitable for steam cooking. Perforated trays are suitable to discharge the condensed water or liquids coming from foods.

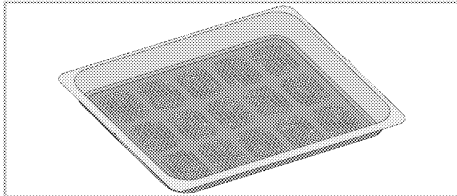

### 8. Water container

Container which holds water to be used in steam cooking.

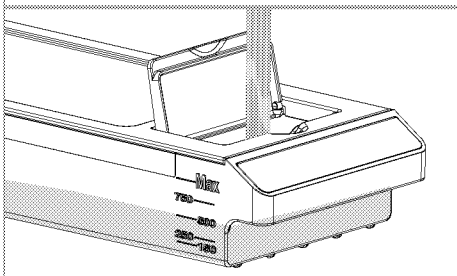
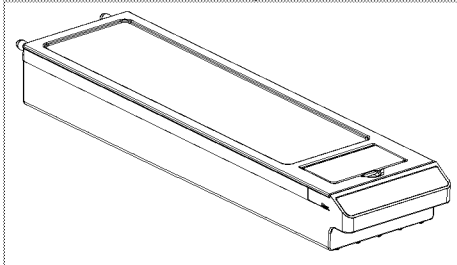

### 9. Descaling tablet

Used in descaling function. Two tablets are provided with the product.

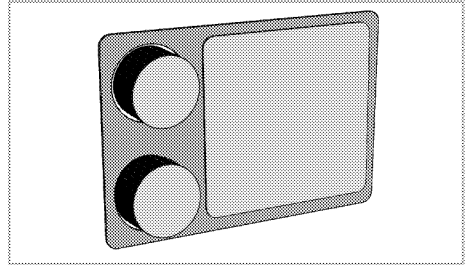

Harmful if swallowed. Causes skin irritation. Causes serious eye irritation. May cause an allergic skin reaction. May cause respiratory irritation. Keep out of reach of children.

Wash hands thoroughly after handling. IF SWALLOWED: Call a POISON CENTER/doctor if you feel unwell. IF IN EYES: Rinse cautiously with water for several minutes. Remove contact lenses, if present and easy to do.

Continue rinsing. If eye irritation persists: Get medical advice/attention. Dispose of contents/container in accordance with local regulations. Tablets contain maleic acid. Store only in a dry and cool place. Residues can be washed with water.

## Technical specifications

Voltage / frequency	220-240 V ~ 50 Hz
Total power consumption	3.4 kW
Cable type / section	min.H05VV-FG 3 x 1,5 mm <sup>2</sup>
External dimensions (height / width / depth)	595 mm/594 mm/567 mm
Installation dimensions (height / width / depth)	**590 or 600 mm/560 mm/min. 550 mm
Main oven	<b>Full steam oven</b>
Inner lamp	15/25 W
Grill power consumption	2.2 kW

# Basics: Information on the energy label of electrical ovens is given in accordance with the EN 60350-1 / IEC 60350-1 standard. Those values are determined under standard load with bottom-top heater or fan assisted heating (if any) functions.

Energy efficiency class is determined in accordance with the following prioritization depending on whether the relevant functions exist on the product or not. 1-Cooking with eco-fan, 2- Turbo slow cooking, 3- Turbo cooking, 4- Fan assisted bottom/top heating, 5-Top and bottom heating.

\*\* See. *Installation*, page 16.

 Technical specifications may be changed without prior notice to improve the quality of the product.

 Figures in this manual are schematic and may not exactly match your product.

 Values stated on the product labels or in the documentation accompanying it are obtained in laboratory conditions in accordance with relevant standards. Depending on operational and environmental conditions of the product, these values may vary.

## 3 Installation

Product must be installed by a qualified person in accordance with the regulations in force. The manufacturer shall not be held responsible for damages arising from procedures carried out by unauthorized persons which may also void the warranty.

 Preparation of location and electrical installation for the product is under customer's responsibility.

 The product must be installed in accordance with all local electrical regulations.

 Prior to installation, visually check if the product has any defects on it. If so, do not have it installed. Damaged products cause risks for your safety.

### Before installation

The appliances must not be installed behind a decorative door in order to avoid overheating.

The appliance is intended for installation in commercially available kitchen cabinets. A safety distance must be left between the appliance and the kitchen walls and furniture. See figure (values in mm).

- Surfaces, synthetic laminates and adhesives used must be heat resistant (100 °C minimum).
- Kitchen cabinets must be set level and fixed.
- If there is a drawer beneath the oven, a shelf must be installed in order to separate from the oven and drawer.
- Carry the appliance with at least two persons.
- Hold the oven from the slots for handling on both sides to move it.
- Before installing the product, remove all materials and documents inside.
- Kitchen furniture must be in compliance with the dimensions given in the figure below. At the rear section of the kitchen furniture, an opening must be cut out with the dimensions given in the figure below to ensure sufficient ventilation.
-  Do not install the appliance next to refrigerators or freezers. The heat emitted by the appliance will lead to an increased energy consumption of cooling appliances.
-  The door and/or handle must not be used for lifting or moving the appliance.



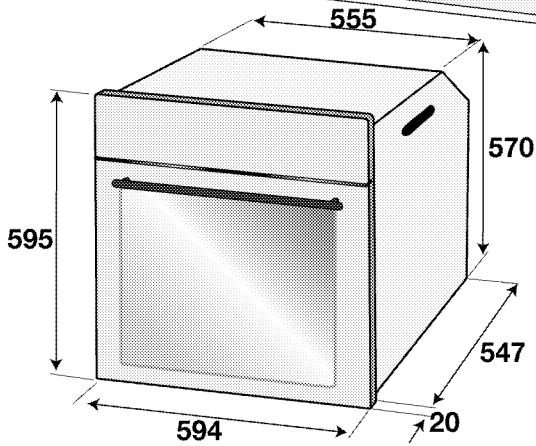
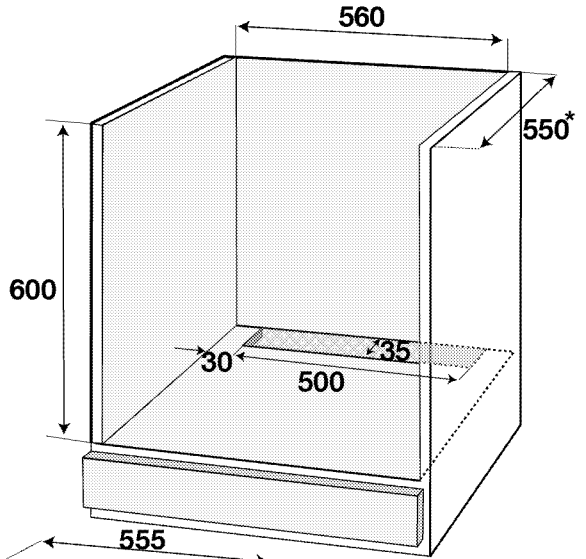
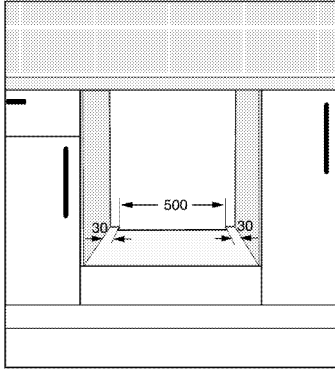
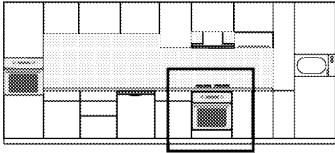

\* min.

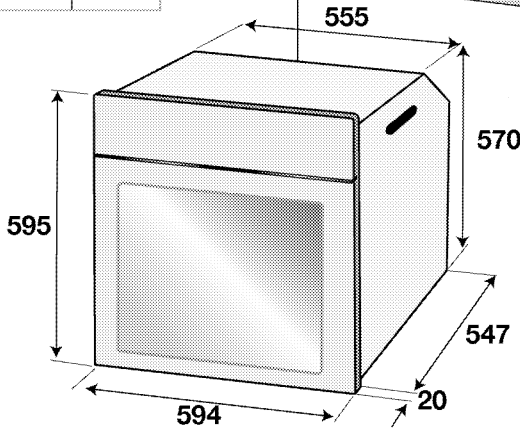
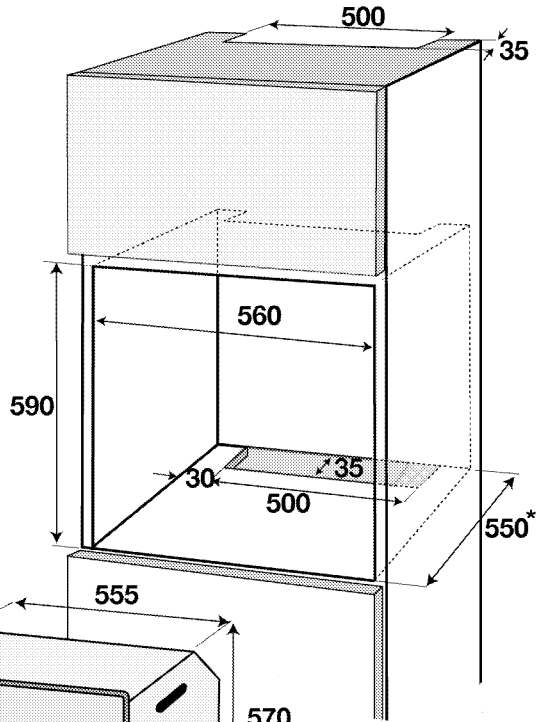
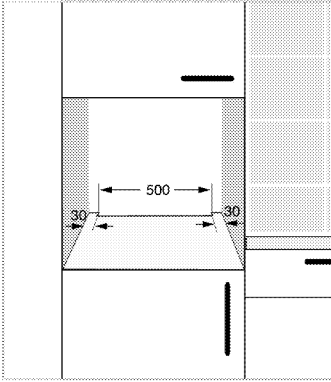
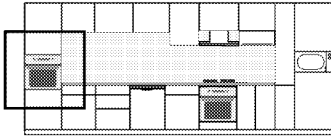

\* min.

## Installation and connection

- The product must be installed in accordance with all local gas and electrical regulations.

### Electrical connection

Connect the product to a grounded outlet/line protected by a miniature circuit breaker of suitable capacity as stated in the "Technical specifications" table. Have the grounding installation

made by a qualified electrician while using the product with or without a transformer. Our company shall not be liable for any damages that will arise due to using the product without a grounding installation in accordance with the local regulations.

**!** The product must be connected to the mains supply only by an authorised and qualified person. The product's warranty period starts only after correct installation.

Manufacturer shall not be held responsible for damages arising from procedures carried out by unauthorised persons.

**!** The power cable must not be clamped, bent or trapped or come into contact with hot parts of the product.

A damaged power cable must be replaced by a qualified electrician. Otherwise, there is risk of electric shock, short circuit or fire!

- Connection must comply with national regulations.
- The mains supply data must correspond to the data specified on the type label of the product. Open the front door to see the type label.
- Power cable of your product must comply with the values in "Technical specifications" table.

**!** Before starting any work on the electrical installation, disconnect the product from the mains supply.

There is the risk of electric shock!

**i** Power cable plug must be within easy reach after installation (do not route it above the hob).

**i** While performing the wiring, you must apply with the national/local electrical regulations and must use the appropriate socket outlet/line and plug for oven. In case of the product's power limits are out of current carrying capability of plug and socket outlet/line, the product must be connected through fixed electrical installation directly without using plug and socket outlet/line.

Plug the power cable into the socket.

### Installing the product

1. Slide the oven into the cabinet, align and secure it while making sure that the power cable is not broken and/or trapped.

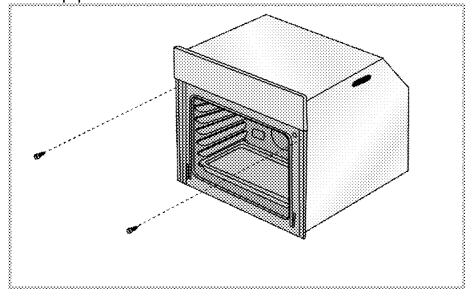

Secure the oven with 2 screws as illustrated.

After the installation, make sure that the screws are sufficiently tightened and the oven does not move. Oven may tip over during use if it is not installed as per the instructions and if the screws are not sufficiently tightened.

## For products with cooling fan (This may not exist on your product.)

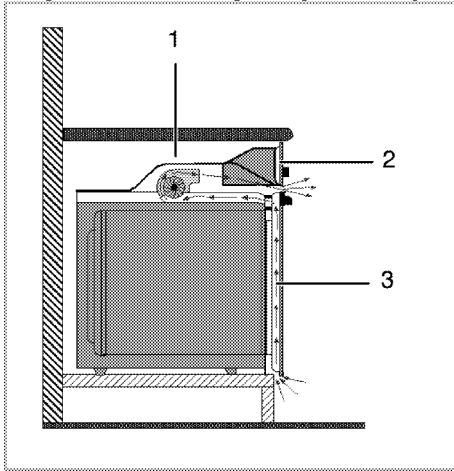

- 1 Cooling fan
- 2 Control panel
- 3 Door

The built-in cooling fan cools both the built-in cabinet and the front of the product.

- i** Cooling fan continues to operate for about 20-30 minutes after the oven is switched off.

If you have cooked by programming the timer of the oven, cooling fan will also be switched off at the end of the cooking time together with all functions.

## Final check

1. Operate the product.
2. Check the functions.

## Future Transportation

- Keep the product's original carton and transport the product in it. Follow the instructions on the carton. If you do not have the original carton, pack the product in bubble wrap or thick cardboard and tape it securely.
- To prevent the wire grill and tray inside the oven from damaging the oven door, place a strip of cardboard onto the inside of the oven door that lines up with the position of the trays. Tape the oven door to the side walls.
- Do not use the door or handle to lift or move the product.

- i** Do not place any objects onto the product and move it in upright position.

- i** Check the general appearance of your product for any damages that might have occurred during transportation.

## 4 Preparation

### Tips for saving energy

The following information will help you to use your appliance in an ecological way, and to save energy:

- Use dark coloured or enamel coated cookware in the oven since the heat transmission will be better.
- While cooking your dishes, perform a preheating operation if it is advised in the user manual or cooking instructions.
- Do not open the door of the oven frequently during cooking.
- If door is not opened, inner temperature is optimized to save

energy on ECO FAN HEATING mode and may differ from the display.



- Try to cook more than one dish in the oven at the same time whenever possible. You can cook by placing two cooking vessels onto the wire shelf.
- Cook more than one dish one after another. The oven will already be hot.
- You can save energy by switching off your oven a few minutes before the end of the cooking time. Do not open the oven door.
- Defrost frozen dishes before cooking them.

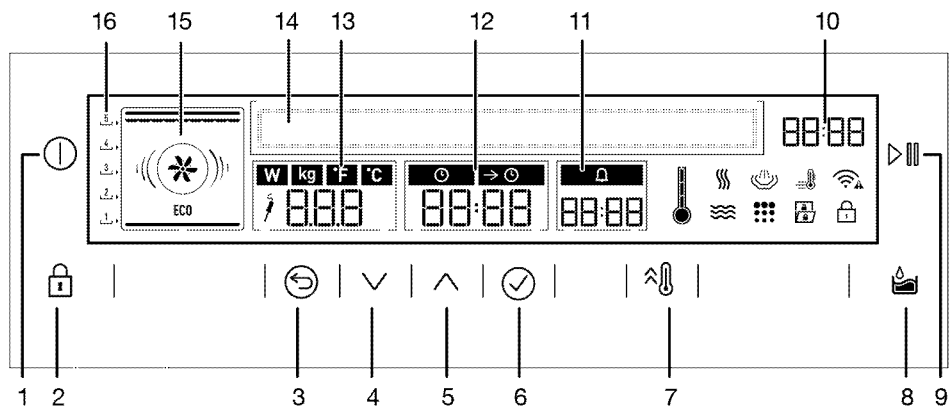



### Initial use Time setting



- |                                     |  |
|-------------------------------------|--|
| 1 ON/OFF key                        | 12 Cooking time/cooking end time field |
| 2 Key lock key                      | 13 Temperature/weight indicator field  |
| 3 Back key                          | 14 Text display                        |
| 4 Down key (Menu Selection)         | 15 Function display                    |
| 5 Up key (Menu Selection)           | 16 Shelf positions                     |
| 6 OK key                            |  |
| 7 Rapid heating key                 |  |
| 8 Water container cover release key |  |
| 9 Start/stop cooking key            |  |
| 10 Current time indicator field     |  |
| 11 Alarm time field                 |  |

### Language setting







1. When the oven is switched on, "Cooking Programs" will be shown on the text display.
2. Touch  until "Settings" is displayed on the text display.
3. Touch .

4. Touch  until "Language" is displayed on the text display.
5. Touch . The language that was initially set for the oven will be displayed.
6. Touch  to select the desired language.
7. Touch  to confirm the setting.

### Set the time

When the oven is powered for the first time, "00:00" will be set automatically.

To change the time setting:

1. When the oven is switched on, "Cooking Programs" will be shown on the text display.
2. Touch  until "Settings" is displayed on the text display.
3. Touch .
4. Touch  until "Clock" is displayed on the text display.
5. Touch .
6. Touch  to set the current time.
7. Touch  to confirm the setting.

### First cleaning of the appliance

 The surface might get damaged by some detergents or cleaning materials.









Do not use aggressive detergents, cleaning powders/creams or any sharp objects during cleaning.

Do not use harsh abrasive cleaners or sharp metal scrapers to clean the oven door glass since they can scratch the surface, which may result in shattering of the glass.

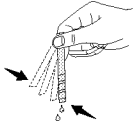
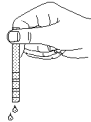
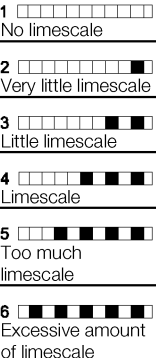

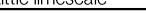

1. Remove all packaging materials.
2. Wipe the surfaces of the appliance with a damp cloth or sponge and dry with a cloth.

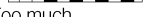
### Adjust the water hardness level

You must adjust the water hardness level for your oven during the initial use. The range for the hardness level of the water to be used is indicated in the table below. This is necessary to remove the limescale on the surfaces of the steam generation system at the right time. Preparation process of the test strip is described below.

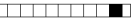







A	B	C	D	E	F
					 <p>1  No limescale</p> <p>2  Very little limescale</p> <p>3  Little limescale</p> <p>4  Limescale</p> <p>5  Too much limescale</p> <p>6  Excessive amount of limescale</p>
Unpack the test strip.	Let the water tap flow for 1 minute.	Soak the test strip in water for 1 minute.	Take it out of the water and shake it.	Wait for 1 minute.	Adjust the water hardness level of your product based on the result obtained from the test strip.

## Water hardness adjustment table

Hardness level	British water hardness level °dE	German water hardness level °dH	French water hardness level °dF	Level of hardness	Water hardness level to be set for the oven
1 	0-5	0-4	0-8	Soft water	1
2 	6-9	5-7	9-13	Partially soft water	
3 	10-15	8-12	14-22	Partially medium-hard water	2
4 	16-19	13-15	23-27	Medium-hard water	
5 	20-24	16-19	28-34	Partially hard water	3
6 	25-62	20-50	35-90	Hard water	

- Do not hold the test strip under running water; perform the measurement in a glass.
- Waiting for longer than 1 minute will lead to incorrect results.
- If the result is hard water, you can also use bottled water. You can repeat the measurement for bottled water if you wish so.
- Select the input value suitable for the number of areas that change colour on the test strip from the table above, and enter the information on the relevant menu screen.
- After the measurement, keep the test strip away from children and dispose it. Empty the water inside the measurement glass.

### Water hardness level

1. When the oven is powered for the first time, "**Cooking Programs**" message will be displayed on the text display.
2. Touch  /  until "**Settings**" is displayed on the text display.
3. Touch .
4. Touch  /  until "**Water hardness**" is displayed on the text display.
5. Touch . The previously set water hardness level will be displayed.
6. Touch  /  to select the level that is suitable for the hardness level of the water you use after the measurement.

7. Touch  to confirm the setting.

### Initial heating

Heat up the product for about 30 minutes and then switch it off. Thus, any production residues or layers will be burnt off and removed.



Hot surfaces cause burns!

Product may be hot when it is in use. Never touch the hot burners, inner sections of the oven, heaters and etc. Keep children away. Always use heat resistant oven gloves when putting in or removing dishes into/from the hot oven.

### Electric oven

1. Take all baking trays and the wire grill out of the oven.
2. Close the oven door.
3. Select Static position.
4. Select the highest grill power; See *How to operate the electric oven, page 26*.
5. Operate the oven for about 30 minutes.
6. Turn off your oven; See *How to operate the electric oven, page 26*

### Grill oven

1. Take all baking trays and the wire grill out of the oven.
2. Close the oven door.
3. Select the highest grill power; see .

4. Operate the grill about 15 minutes.

5. Turn off your grill; see

**i** Smoke and smell may emit for a couple of hours during the initial operation. This is quite normal. Ensure that the room is well ventilated to remove the smoke and smell. Avoid directly inhaling the smoke and the smell that emits.



## 5 How to operate the oven

### General information on baking, roasting and grilling



Hot surfaces cause burns! Product may be hot when it is in use. Never touch the hot burners, inner sections of the oven, heaters and etc. Keep children away. Always use heat resistant oven gloves when putting in or removing dishes into/from the hot oven.



Be careful when opening the oven door as steam may escape. Exiting steam can scald your hands, face and/or eyes.

### Tips for baking

- Use non-sticky coated appropriate metal plates or aluminum vessels or heat-resistant silicone moulds. The vessels must also be resistant to extreme steam.
- Make best use of the space on the rack.
- Place the baking mould in the middle of the shelf.
- Select the correct rack position before turning the oven or grill on. Do not change the rack position when the oven is hot.
- Keep the oven door closed.

### Tips for roasting

- Treating whole chicken, turkey and large piece of meat with dressings such as lemon juice and black pepper before cooking will increase the cooking performance.
- It takes about 15 to 30 minutes longer to roast meat with bones when compared to roasting the same size of meat without bones.

- Each centimeter of meat thickness requires approximately 4 to 5 minutes of cooking time.
- Let meat rest in the oven for about 10 minutes after the cooking time is over. The juice is better distributed all over the roast and does not run out when the meat is cut.
- Fish should be placed on the middle or lower rack in a heat-resistant plate.

### Tips for grilling

When meat, fish and poultry are grilled, they quickly get brown, have a nice crust and do not get dry. Flat pieces, meat skewers and sausages are particularly suited for grilling as are vegetables with high water content such as tomatoes and onions.

- Distribute the pieces to be grilled on the wire shelf or in the baking tray with wire shelf in such a way that the space covered does not exceed the size of the heater.
- Slide the wire shelf or baking tray with grill into the desired level in the oven. If you are grilling on the wire shelf, slide the baking tray to the lower rack to collect fats. The baking tray to be slid must be of a size that covers the whole grilling area. This tray might not be provided with the product. Add some water in the baking tray for easy cleaning.



Foods that are not suitable for grilling carry the risk of fire. Only grill food which is suitable for intensive grilling heat. Do not place the food too far in the back of the grill. This is the hottest area and fatty food may catch fire.

## How to operate the electric oven

### Cooking functions table

Function table indicates the functions that can be used in the oven and their respective maximum and minimum temperatures. Recommended temperature is displayed when the function is selected.

- i** Functions vary depending on the product model.
- i** Due to safety reasons, maximum time that can be set for "Cooking time" is limited with 6 hours at all positions apart from "Keep Warm" and "Low Temp. Cooking" functions.
- i** When setting a function, the frame light of the relevant setting becomes on.
- i** Program will be cancelled in case of power failure. You must reprogram the oven.
- i** Current time cannot be set while the oven is operating in any function, or if semi-automatic or full automatic programming is made on the oven.
- i** Even if the oven is switched off, oven lamp lights up when the oven door is opened.
- i** At temperatures 280°C and higher, the oven operates for max. 2 hours.

Function	Temperature range (°C)
Steam + Fan Heating	40-280
Eco fan heating	160-220
Fan Heating	40-280
3D Cooking	40-280
Steam + Grill + Fan	40-280
Grill	40-280
Low grill	40-280
Grill with Fan	40-280
Steam + Pizza	50-250
Pizza	50-310
Bottom heating	40-220
Low temperature cooking	50-150
Warm keeping	40-100

\* Functions vary depending on the product model.

### Switching off the electric oven

Touch On/Off key to switch off the oven.

### Rack positions (For models with wire shelf)

It is important to place the wire shelf onto the side rack correctly. Wire shelf must be inserted between the side racks as illustrated in the figure.

Do not let the wire shelf stand against the rear wall of the oven. Slide your wire shelf to the front section of the rack and settle it with the help of the door in order to obtain a good grill performance. (Varies depending on the product model.)

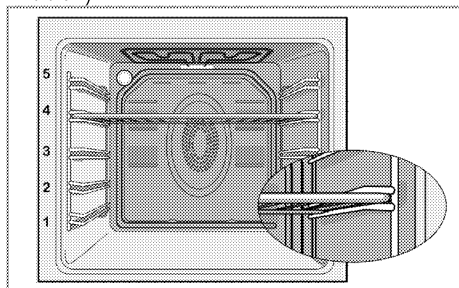

### Operating modes

The order of operating modes shown here may be different from the arrangement on your product. You can see the names of the cooking functions and the recommended rack positions on the oven's time display.

Function	Temperature range (°C)
Steam cooking	40-100
Steam + Fan Assisted cooking	40-280
Conventional Cooking	40-310
Fan Assisted cooking	40-280

### Steam cooking

Cooking is performed using steam. It is suitable to cook foods such as vegetables, red meat, fish and poultry using steam. Since the steam covers the surface of the food, its nutritional components are prevented from being lost during cooking.

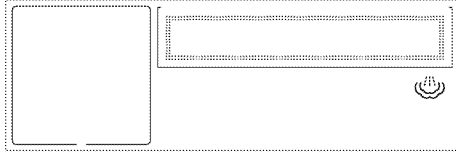

### Fan Assisted cooking

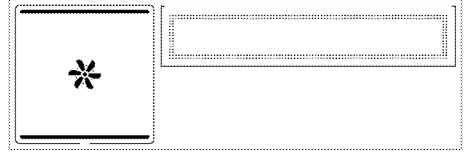

### Steam + Fan Heating

Hot air heated by the rear heater is evenly distributed throughout the oven rapidly by means of the fan. Plus, this function has steam support, too. It is suitable for cooking your meals in different rack levels and preheating is not required in most cases. Suitable for cooking with multi trays.

**i** When the oven door is opened, the fan motor will not run in order to keep the hot air inside.

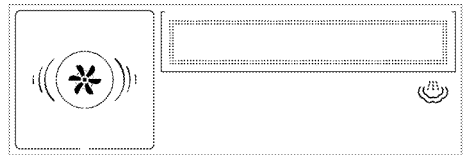

### Steam + Fan Assisted cooking

Hot air heated by the bottom and top heaters is evenly distributed throughout the oven rapidly by means of the fan. Plus, this function has steam support, too. Cook with one tray.



### Conventional Cooking

Food is heated simultaneously from the top and bottom. It is suitable for cakes, pastries, or cakes and casseroles in baking moulds. Cook with one tray.

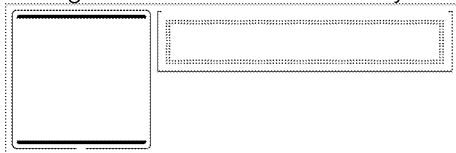

### Fan Assisted cooking

Hot air heated by the bottom and top heaters is evenly distributed throughout the oven rapidly by means of the fan. Cook with one tray.

### Eco Fan Heating

To save power, you can use this function instead of the cooking operations that you would perform by using Fan Heating at 160-220°C temperature range. However, the cooking time will increase a little bit. Cooking times related to this function are indicated in table 'Eco Fan Heating'.

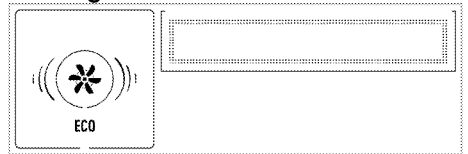

## Fan Heating

Hot air heated by the rear heater is evenly distributed throughout the oven rapidly by means of the fan. It is suitable for cooking your meals in different rack levels and preheating is not required in most cases. Suitable for cooking with multi trays.

**i** When the oven door is opened, the fan motor will not run in order to keep the hot air inside.

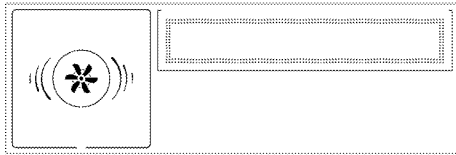

## Grill

Hot air heated by the full grill is distributed very fast in the oven by means of the fan. It is suitable for grilling a large amount of meat.

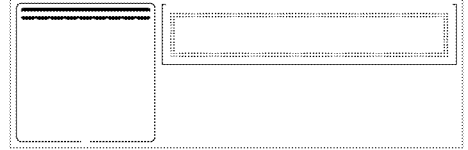

- Put big or medium-sized portions in correct rack position under the grill heater for grilling.
- Turn the food after half of the grilling time.

## 3D Cooking

Top heating, bottom heating and fan assisted heating are in operation. Food is cooked evenly and quickly all around. Cook with one tray.

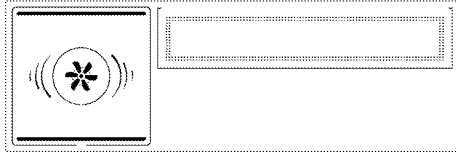

## Low grill

Small grill at the ceiling of the oven is in operation. Suitable for grilling and gratin dishes.

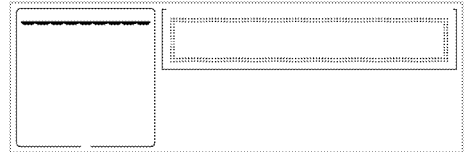

- Put small or medium-sized portions in correct rack position under the grill heater for grilling.
- Turn the food after half of the grilling time.

## Steam + Grill + Fan

Large grill at the ceiling of the oven is in operation. It is suitable for grilling a large amount of meat. Plus, this function has steam support, too.



- Put big or medium-sized portions in correct rack position under the grill heater for grilling.
- Turn the food after half of the grilling time.

## Grill with Fan

Hot air heated by the full grill is distributed very fast in the oven by means of the fan. It is suitable for grilling large amount of meat.



### Grill with Fan

- Put big or medium-sized portions in correct rack position under the grill heater for grilling.
- Turn the food after half of the grilling time.

### Steam + Pizza

Bottom heating and fan assisted heating (in the rear wall) are in operation. Plus, this function has steam support, too. It is suitable to cook foods like pizza and pastry.



### Pizza

Bottom heating and fan assisted heating (in the rear wall) are in operation. Suitable for baking pizza.

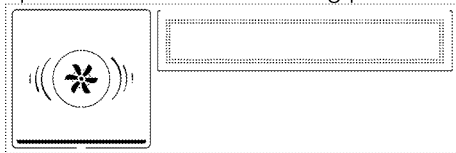

### Bottom heating

Only bottom heater is in operation. It is suitable for pizza and for subsequent browning of food from the bottom.



### Low temperature cooking

Food is heated simultaneously from the top and bottom. It is suitable for slow-cooking of roasted/seared pieces of meat (veal, lamb, poultry etc.) in an open container at low temperature. This function ensures that the meat is juicy and soft on the inside. Please use hygienically suitable types of meat. On the hob, grill etc., pre-roast/sear all surfaces of the meat in a hot pan. You can cook the pre-roasted/seared meat with the “low temperature cooking” function for a long time. Cook with one tray only.



### Warm keeping

Used for keeping food at a temperature ready for serving for a long period of time.

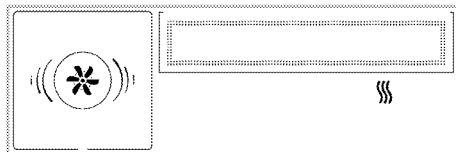

### STEAM SUPPORT

The following functions are equipped with steam support.

- Steam + Conventional Cooking
- Steam + Fan Heating
- Steam + Grill
- Steam + Pizza

Each function is equipped with three different levels of steam: low, medium and high. These functions emit steam for the cooking load at regular intervals. It is recommended to use the low steam level to cook pastries such as cake, buns, etc.







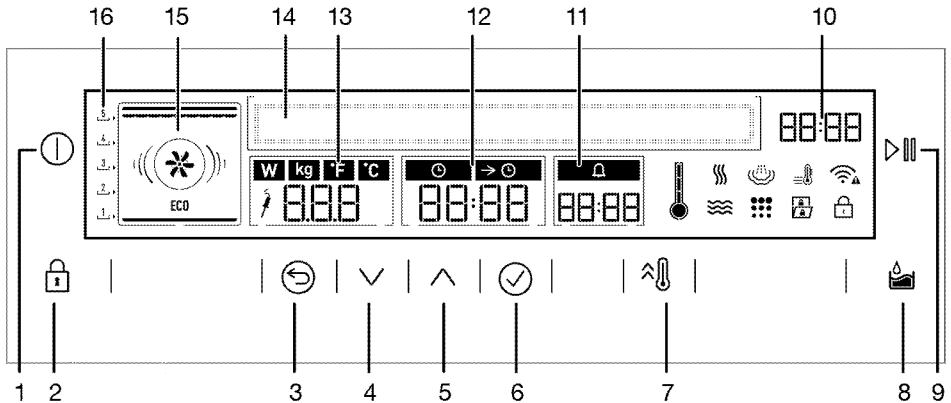

It is recommended to use the medium steam level to cook pastries such as bread. Steam ensures that the surface of pastries are brighter, the crust is more crispy and the size is bigger.



High steam level is recommended for meats (large pieces of meat, whole chicken, etc.). Steam reduces moisture loss when cooking meat, allowing the meat to be more moist and juicy.

### Control panel introduction







- 1 ON/OFF key
- 2 Key lock key
- 3 Back key
- 4 Down key (Menu Selection)
- 5 Up key (Menu Selection)
- 6 OK key
- 7 Rapid heating key
- 8 Water container cover release key
- 9 Start/stop cooking key
- 10 Current time indicator field
- 11 Alarm time field
- 12 Cooking time/cooking end time field
- 13 Temperature/weight indicator field
- 14 Text display
- 15 Function display
- 16 Shelf positions



-  : Alarm symbol
  -  : Inner temperature symbol
  -  : Keep warm symbol
  -  : Key lock symbol
  -  : Open door symbol
  -  : Meat Probe symbol\*
  -  : Self cleaning (pyrolysis) symbol\*
  -  : Steam cooking symbol
- \*(Varies depending on the product model.)





-  : Booster symbol
-  : Cooking Time symbol
-  : End of Cooking Time symbol





### Cooking Programs Menu





#### Using the oven functions to cook without steam





1. Touch  to switch on the oven.
2. Main menu will be displayed when the oven is switched on.
3. Touch  to access the cooking programs menu.
4.  /  to select the desired oven function without steam. Touch  to activate the function.

5. If you would like to change the temperature, touch  /  when in the temperature/weight frame and set the desired temperature. The temperature value will be confirmed as soon as it is changed.

 The active field from Temperature/weight, Cooking time and Alarm time fields is surrounded by a frame. Touch  to move the frame to the indication fields on the right, or touch  to move it to the fields on the left. If you touch  again when the frame is on the Temperature/weight display field on the left, the screen will return to the previous menu.

6. **To set the cooking time**, touch  to move the frame to the Cooking time/cooking end time field.  will be displayed. Touch  /  to set the desired cooking time.

7. **To set the cooking end time to a later time**, touch  after setting the cooking time.   will be displayed. Touch  /  to set the desired cooking end time.



8. **To set an alarm time without affecting the reminder**, touch  to move the frame to the Alarm time frame.  will be displayed. Touch  /  to set the desired alarm time. The alarm time is for reminding purposes, it does not affect the cooking time or functioning of the oven. For example, this is useful when you want to turn food in the oven at a certain point of time.

 Maximum alarm time can be 23 hours and 59 minutes.

9. If the cooking function, temperature, cooking time, cooking end time and the alarm time are suitable, touch 

to start cooking. Cooking will start, and the display will show the set operating function and **"Cooking"** message respectively.

 Setting the cooking time, cooking and time and alarm time is not necessary for the oven to operate. It can be set optionally.











 If the oven door is opened during cooking,  symbol appears on the display.





» **If a cooking time has not been set;** the oven is operating manually. If your food is cooked, touch  to stop the oven. Otherwise, the oven will continue to operate.





» **If only a cooking time has been set;** the oven will stop at the end of the cooking time. The display will show the oven function and "Cooking is complete" message respectively. The oven will start to emit an audio warning. Touch any key to silence the audio warning.

» **If a cooking time and a cooking end time have been set;** the oven's clock will subtract the cooking time from the cooking end time you have set to calculate the cooking start time. When the cooking start time has come, the selected oven function will be activated and the oven will be heated to the set temperature. It maintains this temperature until the end of cooking time. The oven will stop at the end of the cooking time. The display will show the oven function and "Cooking is complete" message respectively. The oven will start to emit an audio warning. Touch any key to silence the audio warning.



## Using the oven functions to perform steam cooking and steam assisted cooking



1. Touch  to switch on the oven.
2. Main menu will be displayed when the oven is switched on.
3. Touch  to access the cooking programs menu.
4. Touch  to select steam cooking or the desired steam assisted function. Touch  to activate the function.
5. Touch . Use  /  to adjust the steam level. Touch  again to confirm the setting.
6. If you would like to change the temperature, touch  /  when in the temperature/weight frame and set the desired temperature. The temperature value will be confirmed as soon as it is changed.





 The active field from Temperature/weight, Cooking time and Alarm time fields is surrounded by a frame. Touch  to move the frame to the indication fields on the right, or touch  to move it to the fields on the left. If you touch  again when the frame is on the Temperature/weight display field on the left, the screen will return to the previous menu.

7. **To set the cooking time**, touch  to move the frame to the Cooking time/cooking end time field.  will be displayed. Touch  /  to set the desired cooking time.

This function does not allow you to start cooking before setting a cooking time. The cooking time is automatically set to 30 minutes on the display.

8. **To set the cooking end time to a later time**, touch  after setting the cooking time.  will be displayed.

Touch  /  to set the desired cooking end time.

9. **To set an alarm time without affecting the reminder**, touch  to move the frame to the Alarm time frame.  will be displayed. Touch  /  to set the desired alarm time. The alarm time is for reminding purposes, it does not affect the cooking time or functioning of the oven. For example, this is useful when you want to turn food in the oven at a certain point of time.

 Maximum alarm time can be 23 hours and 59 minutes.

10. If the cooking function, temperature, cooking time, cooking end time and the alarm time are suitable, touch  to start cooking.

### 11. Steam function operating steps:

If you have not performed steam cooking for a long time, "Add clean water" message will be displayed.

12. Touch . The cover of the water container will open sideways and the water container will come out.

 In some models, the cover of water container will open frontways.



13. Take out the water container, empty the water in it (if any) and add clean water up to the "max." level at most.

 Risk for health! Do not use any other liquids apart from potable water in the steam system.

 Do not use distilled or filtered water. Use bottled water only. Do not add solutions that are inflammable, contain alcohol or solid particles into the water container.



**i** Thanks to the lid on the container, you can fill it without taking it out.

14. Place the container and touch  to close its cover. Touch  to start cooking.

» If the water level is suitable, cooking process will start.

**i** If the oven door is opened during cooking,  symbol appears on the display.

**i** If the water in the container is depleted during cooking, **"Please add water"** message will be displayed and the oven will emit an audio warning. Cooking will stop. Once you have re-filled the container with water and placed it into its housing again, the cooking cycle will continue where it left off.

» » **If only a cooking time has been set;** the oven will stop at the end of the cooking time. The display will show the oven function and **"Cooking completed"** message respectively. The oven will start to emit an audio warning. Touch any key to silence the audio warning.

» » **If a cooking time and a cooking end time have been set;** the oven's clock will subtract the cooking time from the cooking end time you have set to calculate the cooking start time. When the cooking start time has come, the selected oven function will be activated and the oven will be heated to the set temperature. It maintains this temperature until the end of cooking time. The oven will stop at the end of the cooking time. The display will show the oven function and **"Cooking completed"** message respectively. The oven will start to emit an audio warning.

Touch any key to silence the audio warning.

15. At the end of the cooking cycle, discharge the remaining water in the container for reasons of hygiene.

**i** The water in the water generation system of the oven will be sent to the water container in about 15 minutes once the cooking is completed. Discharge this water remaining in the water container for reasons of hygiene.

16. Please activate the drying function for the water accumulated in the oven. See "Extras Menu".

**i** When the automatic drying function is active, it will automatically turn on at the end of each steam cooking cycle.

17. **To continue cooking: In 5 minutes after the cooking cycle has ended,** you can touch  to operate the oven with steam/steam assisted functions again.



» The oven will continue operating with the same cooking function and temperature setting.

18. If you want to operate the oven again **in 5 minutes after the cooking cycle has been completed,** the message **"Oven is getting ready"** will be displayed since the oven will have started to send the water in the steam generation system back to the water container. Once this message has disappeared, you can touch  to start cooking. Since the water in the water generation system has been sent to the water container, **"Add clean water"** message will be displayed.

19. Touch . The cover of the water container will open sideways and the water container will come out.

**i** In some models, the cover of the water container will open frontways.

20. Take out the water container, empty the water in it (if any) and add clean water up to the "max." level at most.

21. Place the container and touch  to close its cover. Touch  to start cooking.

» If the water level is suitable, cooking process will start.

**i** If you open the oven door while a steam function is running, the fan motor will run at high speed to create an air curtain.

**i** During the last 3 minutes of steam cooking, the fan motor will run at high speed to reduce steam density in the oven.

22. At the end of the cooking cycle, discharge the remaining water in the container for reasons of hygiene.

**i** The water in the water generation system of the oven will be sent to the water container in about 15 minutes once the cooking is completed. Discharge this water remaining in the water container for reasons of hygiene.



23. Please activate the drying function for the water accumulated in the oven. See "Extras Menu".

**i** When the automatic drying function is active, it will appear on the oven display at the end of each steam cooking process. You can touch  to start it.

**i** Before starting the drying function, take out the food and accessories such as trays, wire grills, etc. from the oven.



### Setting the Booster (Rapid heating)

Use the Booster (rapid pre-heating) function to make the oven reach the desired temperature faster. Select the desired cooking function and then:

1. Touch  once.  symbol will appear on display.

2. After setting the cooking time and temperature, touch  to start cooking.

»  Symbol disappears as soon as the oven reaches the desired temperature and oven resumes operating in the function it was in before the Booster function.



3. Touch  once to cancel the booster function. Booster will be deactivated and  will disappear.

### Activating the key lock

You can prevent the oven from being intervened with by activating the key lock function.

**i** Key lock can be used either when the oven is operating or not. Oven can be switched off by touching the  even when the key lock is activated while the oven is operating.

1. Touch  until "🔒" appears on the display.











» After activating the keylock, "Keylock active" warning and  symbol will appear on the display when you press any key (except  /  keys).

**i** Oven buttons are not functional when the key lock function is active. Key lock will not be cancelled in case of power failure.





## Deactivating the key lock













1. Touch  until "🔒" disappears on the display.  
» Key lock will be deactivated.







## Automatic Cooking Functions Menu

1. Touch  to switch on the oven.
2. Main menu will be displayed when the oven is switched on. Touch  /  until "Automatic Cooking Menu" is displayed.
3. Touch  to access the automatic cooking menu.
4. Touch  /  to select the main menu of the food you are going to cook. (Refer to the automatic cooking menu table). Touch  to confirm.
5. Touch  /  to select the food you wish to cook.
6. To change the weight of the food, touch  /  when the Temperature/weight field is within the frame and set the weight. The weight value will be confirmed as soon as it is changed. The cooking time will change automatically based on the weight of the food.

 You can only change the weight for meals for which a weight is indicated.

 The active field from Temperature/weight, Cooking time and Alarm time fields is surrounded by a frame. Touch  to move the frame to the indication fields on the right, or touch  to move it to the fields on the left. If you touch  again when the frame is on the Temperature/weight display field on the left, the screen will return to the previous menu.

7. To set the cooking time, touch  to move the frame to the Cooking time field.  will be displayed. Touch  /  to set the desired cooking time. The number of changes to the cooking time based on the weight of the food is limited.
8. If the cooking function, temperature, weight and cooking time are suitable, touch  key to start cooking.
9. **If the selected food contains steam function, follow the instructions for steam function below:**  
If you have not performed steam cooking for a long time, "Add clean water" message will be displayed.
10. Touch . The cover of the water container will open sideways and the water container will come out.  
 In some models, the cover of water container will open frontways.
11. Take out the water container, empty the water in it (if any) and add clean water up to the "max." level at most.  
 Risk for health! Do not use any other liquids apart from potable water in the steam system.  
 Do not use distilled or filtered water. Use bottled water only. Do not add solutions that are inflammable, contain alcohol or solid particles into the water container.  
 Thanks to the lid on the container, you can fill it without taking it out.
12. Place the container and touch  to close its cover. Touch  to start cooking.  
» If the water level is suitable, cooking process will start.

- i** If the oven door is opened during cooking,  symbol appears on the display.
- i** If the water in the container is depleted during cooking, **"Please add water"** message will be displayed and the oven will emit an audio warning. Cooking will stop. Once you have re-filled the container with water and placed it into its housing again, the cooking cycle will continue where it left off.
- » » **If a cooking time has been set;** the oven will stop at the end of the cooking time. The display will show the oven function and **"Cooking completed"** message respectively. The oven will start to emit an audio warning. Touch any key to silence the audio warning.
13. At the end of the cooking cycle, discharge the remaining water in the container for reasons of hygiene.
- i** The water in the water generation system of the oven will be sent to the water container in about 15 minutes once the cooking is completed. Discharge this water remaining in the water container for reasons of hygiene.
14. Please activate the drying function for the water accumulated in the oven. See "Extras Menu".
- i** When the automatic drying function is active, it will automatically turn on at the end of each steam cooking cycle.
- 15. To continue cooking:**  
**In 5 minutes after the cooking cycle has ended,** you can touch  to operate the oven with steam/steam assisted functions again.
- » The oven will continue operating with the same cooking function and temperature setting.
16. If you want to operate the oven again **in 5 minutes after the cooking cycle has been completed,** the message **"Oven is getting ready"** will be displayed since the oven will have started to send the water in the steam generation system back to the water container. Once this message has disappeared, you can touch  to start cooking. Since the water in the water generation system has been sent to the water container, **"Add clean water"** message will be displayed.
17. Touch . The cover of the water container will open sideways and the water container will come out.
- i** In some models, the cover of water container will open frontways.
18. Take out the water container, empty the water in it (if any) and add clean water up to the "max." level at most.
19. Place the container and touch  to close its cover. Touch  to start cooking.
- » If the water level is suitable, cooking process will start.
- i** If you open the oven door while a steam function is running, the fan motor will run at high speed to create an air curtain.
- i** During the last 3 minutes of steam cooking, the fan motor will run at high speed to reduce steam density in the oven.
20. At the end of the cooking cycle, discharge the remaining water in the container for reasons of hygiene.

**i** The water in the water generation system of the oven will be sent to the water container in about 15 minutes once the cooking is completed. Discharge this water remaining in the water container for reasons of hygiene.

21. Please activate the drying function for the water accumulated in the oven. See "Extras Menu".

**i** When the automatic drying function is active, it will appear on the oven display at the end of each steam cooking process. You can touch  to start it.

**i** Before starting the drying function, take out the food and accessories such as trays, wire grills, etc. from the oven.

### Automatic cooking functions:

May vary depending on the models

Vegetables	Cakes & Breads & Tarts	Poultry	Fish	Meat	Special
Fresh Piece of Potato (*)	Fluffy Pogaca (*)	Roast Chicken < 1600gr(*)	Trout	Roast Beef Steam(*)	Macaroni Cheese
Broccoli Florets (*)	Loaf bread (yeasted) (*)	Roast Chicken > 1600gr(*)	Bass	Meatloaf	Classic Lasagna
Fresh Beans (*)	Sandwich Bread (*)	Roast Turkey Thighs(*)	Fish Parcels	Roast Beef	Fresh fruit tart
Stuffed Peppers	Walnut Cookies	Roast Chicken < 1600gr	-	Rolled Lamb	Apple Pie
Jacket potatoes	Cake	Roast Chicken > 1600gr	Trout with Veg.	Lamb Roast	Apple puffs
Moussaka	Cinnamon Rolls	Chicken Piece	Fish fillet	-	Meringue
Layer potatoes	-	Chicken fillets	Fish kebabs	Tandoori Lamb	Éclair
-	Fruit cake	Chicken Grilled	Fish stew	Steak	-
Veg. au gratin	Savoury past.	Roast turkey	Salmon Fillet	Spicy meatballs	Crème Caramel
Frozen Vegetables	Tea rolls	Roast Turkey Thighs	Fish Pie	Beef Sirloin	Choc. pudding
	Baguette	Turkey Fillet	-		Crème Brûlée







Vegetables	Cakes & Breads & Tarts	Poultry	Fish	Meat	Special
	Sandwich Bread	Duck			Honeyed apple
	Load Bread (yeasted)	Goose			Chocolate cake
	Sav. croissants	Rabbit			Semolina Buns
	Croissant plaits	Pheasant hunter			Semolina Cake
	Cheese pasties	Pheasant			Dried Apple
	Bagel				Dried Quince
	Pizza				Dried Pear
	Chocolate loaf				-
	Semolina Buns				Quiche Veg.
					-

\* These dishes contain steam function.

### Extra Programs Menu

#### Descaling (This feature is optional. It may not exist on your product.)

It is recommended to use the descaling program for the lime accumulated in the steam generation system. Your oven will warn you to perform descaling based on the water hardness level you set. Two descaling tablets are provided with the product. (You can also use commercially available descalers, which are recommended for steam assisted cooking appliances, in accordance with their instructions for use.)

1. Touch  to switch on the oven.
2. Main menu will be displayed when the oven is switched on. Touch  /  until "Extra Programs" is displayed.
3. Touch .
4. Touch  /  until "Descaling" is displayed on the text display.

5. Touch . Touch  to start the process.

6. "Put 250ml water and tablet to the tank" will be displayed.

7. Touch . The cover of the water tank will open sideways and the water tank will come out.

 In some models, the cover of water container will open frontways.

8. Add 250 ml clean water and the tablet to the tank. Place the tank and touch

 to close its cover.

9. Touch  again to start the process.

10. During the descaling process, the tablet will dissolve to remove the limescale accumulated in the steam generator of the oven. The oven will perform this process automatically and at the end of the process, "Empty the tank and put 250ml water" message will be displayed.

11. Touch . The cover of the water tank will open sideways and the water tank will come out.

12. Empty the tank and add 250 ml clean water. Place the tank and touch  to close its cover. The process will resume.

13. At the end of the descaling process, "Operation is done" message will be displayed.

 The first phase of the descaling lasts nearly 90 minutes, and the second phase lasts about 20 minutes.







» Open the door of the oven to let the steam out and discharge the remaining water in the water tank.

### **Drying (This feature is optional. It may not exist on your product.)**

It allows for drying inside the oven by evaporating the remaining water in the oven after steam cooking. It is recommended to use this function after every steam cooking for reasons of hygiene.

 Before starting the drying process, remove the food and trays in the oven.

 Before using the drying function, use a dry cloth to wipe the water (if any) accumulated on the oven's base.

1. Touch  to switch on the oven.
2. Main menu will be displayed when the oven is switched on. Touch  /  until "Extra Programs Menu" is displayed.
3. Touch .
4. Touch  /  until "Drying" is displayed on the text display.
5. Touch .

6. Touch  to start drying.

7. After 10 minutes, which is the drying time set automatically, "Open oven door" message will appear on the display.



» Open the door of the oven to let the steam out.

### **Reheat (This feature is optional. It may not exist on your product.)**

It is suitable for reheating cooked meals. The steam support prevents the food from drying.



- Use heat resistant vessels.
- Use perforated tray for steam cooking.
- Do not cover the food when reheating.

1. Touch  to switch on the oven.

2. Main menu will be displayed when the oven is switched on. Touch  /  until "Extra Programs" is displayed.

3. Touch .

4. Touch  /  until "Reheat" is displayed on the text display.

5. Touch . Touch  to start the process. To start the function, follow "Steam function operating steps" described in "Using the oven functions to perform steam cooking and steam assisted cooking".









In this function, recommended temperature and time are displayed. You can change the temperature and time, and set an end time.

### **Dough Proving (This feature is optional. It may not exist on your product.)**

Suitable for proving leavened dough such as bread, pogaca or pizza dough. The steam support prevents the surface of the dough from drying.

- Use heat resistant vessels.
- Do not cover the food when proving.
- Do not open the oven door during the proving process; this may result in moist loss or flat dough.

- Before using the dough proving function, make sure that the baking area is cold enough (at room temperature).
- The proving time may vary according to the size and weight of the dough.
- It is recommended to use heat-resistant large vessels on the wire grill for proving.

1. Touch  to switch on the oven.
2. Main menu will be displayed when the oven is switched on. Touch  /  until "Extra Programs" is displayed.
3. Touch .
4. Touch  /  until "Dough Proving" is displayed on the text display.
5. Touch . Touch  to start the process. To start the function, follow "Steam function operating steps" described in "Using the oven functions to perform steam cooking and steam assisted cooking".

In this function, recommended temperature and time are displayed. You can change the temperature and time, and set an end time.



**Defrost (This feature is optional. It may not exist on your product.)**

Suitable for defrosting frozen food such as fruits, vegetables and pastries. When defrosting, use perforated tray for steam cooking. Place an oven tray under the lower rack (Rack 1) of the perforated steam cooking tray to collect the water coming from the food being defrosted.



 It is recommended to defrost meat, poultry, fish, etc. in the refrigerator for food safety reasons.



 Put frozen foods in the oven after removing their package (if any).

1. Touch  to switch on the oven.

2. Main menu will be displayed when the oven is switched on. Touch  /  until "Extra Programs" is displayed.

3. Touch .

4. Touch  /  until "Defrost" is displayed on the text display.









5. Touch . Touch  to start the process. To start the function, follow "Steam function operating steps" described in "Using the oven functions to perform steam cooking and steam assisted cooking".

In this function, recommended temperature and time are displayed. You can change the temperature and time, and set an end time.

**Blanch (This feature is optional. It may not exist on your product.)**

Suitable for blanching fruits and vegetables before freezing or bottling. When blanching, use perforated tray for steam cooking. Place an oven tray under the lower rack (Rack 1) of the perforated steam cooking tray to collect the water coming from the food being blanched.

 To preserve the colour of the blanched food, put the food in iced water after blanching to cool it, and then drain the water.

1. Touch  to switch on the oven.
2. Main menu will be displayed when the oven is switched on. Touch  /  until "Extra Programs" is displayed.
3. Touch .
4. Touch  /  until "Blanch" is displayed on the text display.
5. Touch . Touch  to start the process. To start the function, follow "Steam function operating steps" described in "Using the oven functions to perform steam cooking and steam assisted cooking".



In this function, recommended time is displayed. You can change the time and set an end time.

**Hygiene (This feature is optional. It may not exist on your product.)**









Suitable for sterilising glass jars and their lids that will be used for bottling.

Use the oven's wire grill when sterilising containers/lids. Place an oven tray under the lower rack (Rack 1) of the grill to collect the water generated due to the steam. Containers/lids must be open. Place the containers/lids upside down so that their top parts contact the wire grill.

**i** Use heat and steam resistant glass containers.

**i** When sterilising more than one container/lid, make sure that they do not contact each other.

**i** Sterilise containers with similar sizes.

1. Touch  to switch on the oven.
2. Main menu will be displayed when the oven is switched on. Touch  /  until "Extra Programs" is displayed.
3. Touch .
4. Touch  /  until "Hygiene" is displayed on the text display.
5. Touch . Touch  to start the process. To start the function, follow "Steam function operating steps" described in "Using the oven functions to perform steam cooking and steam assisted cooking".

In this function, recommended time is displayed. You can change the time and set an end time.

**Bottling (This feature is optional. It may not exist on your product.)**

Suitable for reheating blanched foods (e.g. fruits and vegetables) after putting them into sterilised glass containers.









Add liquid (water, sugared water, salty water, etc.) on the blanched food and then cover it. This way, fill the container to leave a maximum space of 3 cm from top and cover it with the sterilised lid.

When bottling containers, use perforated tray for steam cooking. Place an oven tray under the lower rack (Rack 1) of the perforated steam cooking tray to collect the water generated due to the steam. After cooling the bottled glass containers, take them out from the baking area. After taking the glass containers from the baking area, let them cool down at room temperature.

- When bottling more than one containers, make sure that they do not contact each other.
- Bottle containers with similar sizes.
- Bottling time may vary depending on the amount of food and the number of glass containers.

**i** Use heat and steam resistant glass containers.

**i** Glass containers might crack during the bottling process. Make sure that the containers or lids are not deformed.

1. Touch  to switch on the oven.
2. Main menu will be displayed when the oven is switched on. Touch  /  until "Extra Programs" is displayed.
3. Touch .
4. Touch  /  until "Bottling" is displayed on the text display.
5. Touch . Touch  to start the process. To start the function, follow "Steam function operating steps" described in "Using the oven functions to perform steam cooking and steam assisted cooking".

In this function, recommended temperature and time are displayed. You









can change the temperature and time, and set an end time.

**Chocolate melting (This feature is optional. It may not exist on your product.)**

Suitable for melting pieces of chocolate. Put ready-to-eat packaged chocolate on the perforated tray for steam cooking to melt it.

As for unpacked chocolate pieces, put them in a heat-resistant glass container, put the lid on and place them on the perforated tray for steam cooking.

 Melting time may vary depending on the amount of food.

1. Touch  to switch on the oven.
2. Main menu will be displayed when the oven is switched on. Touch  /  until "Extra Programs" is displayed.
3. Touch .
4. Touch  /  until "Chocolate melting" is displayed on the text display.
5. Touch . Touch  to start the process. To start the function, follow "Steam function operating steps" described in "Using the oven functions to perform steam cooking and steam assisted cooking".









In this function, recommended time is displayed. You can change the time and set an end time.

**Home-made yoghurt (This feature is optional. It may not exist on your product.)**

Suitable for making yoghurt with pasteurised milk. Add 100 gr (3-4 tablespoons) yoghurt to 1000 ml of pasteurised milk at room temperature and mix well. Add this mixture to a heat-resistant glass container and put the lid on. Use the wire grill of the oven when making yoghurt.

- For a sweet and less thicker yoghurt keep the duration shorter and for a sour and thicker yoghurt keep the duration longer.
- When the process is over, it is recommended that the yoghurt is consumed after being kept in the fridge (+4°C) for 12 hours.
- Sterilised long-life milks are not suitable for making yoghurt, and they should not be used.
- The yoghurt used for fermenting should be fresh.

 Milks that are raw and without heat treatment can also be used for making yoghurt but they should be boiled in order to eliminate the pathogens/harmful microorganisms. The boiled milk should be cooled to room temperature before making yoghurt.

1. Touch  to switch on the oven.
2. Main menu will be displayed when the oven is switched on. Touch  /  until "Extra Programs" is displayed.
3. Touch .
4. Touch  /  until "Home-made yoghurt" is displayed on the text display.
5. Touch . Touch  to start the process. To start the function, follow "Steam function operating steps" described in "Using the oven functions to perform steam cooking and steam assisted cooking".

In this function, recommended time is displayed. You can change the time and set an end time.









## **Egg- Hard-boiled, mid-boiled, soft-boiled (This feature is optional. It may not exist on your product.)**

Suitable for boiling eggs at different levels as you wish. You can boil a large number of eggs.

When boiling eggs, use perforated tray for steam cooking. Place an oven tray under the lower rack (Rack 1) of the perforated steam cooking tray to collect the water coming from the food being blanched.

 (Before cooking the eggs, you must prick the eggs at a few points with a sharp tool, e.g. a needle. Otherwise, eggs might explode during the cooking process.

 The egg boiling time may vary depending on the size and number of the eggs.









1. Touch  to switch on the oven.
2. Main menu will be displayed when the oven is switched on. Touch  /  until "Extra Programs" is displayed.
3. Touch .
4. Touch  /  until "Hard-Boiled Egg", "Mid-Boiled Egg" or "Soft-Boiled Egg" is displayed on the text display.
5. Touch . Touch  to start the process. To start the function, follow "Steam function operating steps" described in "Using the oven functions to perform steam cooking and steam assisted cooking".

In this function, recommended time is displayed. You can change the time and set an end time.

### **Steam Clean (This feature is optional. It may not exist on your product.)**

It ensures easy cleaning because the dirt (having waited not for too long) is

softened with water drops condensing inside the oven after giving steam for a certain time.

1. Touch  to switch on the oven.
2. Main menu will be displayed when the oven is switched on. Touch  /  until "Extra Programs" is displayed.
3. Touch .
4. Touch   until "Steam Clean" is displayed on the text display.
5. Touch . Touch  to start the process. To start the function, follow "Steam function operating steps" described in "Using the oven functions to perform steam cooking and steam assisted cooking".

In this function, recommended time is displayed. You can change the time and set an end time.

6. At the end of the time, "Wipe the surfaces" message will be displayed. Open the door and wipe the inner surfaces of the oven with a dry sponge or cloth.

### **Cleaning (pyrolytic self-cleaning) (This feature is optional. It may not exist on your product.)**



Hot surfaces cause burns! Do not touch the product during self cleaning step and keep children away from it. Keep at least 30 minutes before removing the remnants.

The oven is equipped with a pyrolytic self-cleaning feature. The oven is heated to 430-480°C approximately and the existing dirt is burned to ashes. A strong smoke development may arise. Ensure well ventilation. The oven must be cleaned with high heat after each 10 uses.

1. Remove all accessories from the oven. For models with wire rack, remember



to remove the wire rack. Do not forget to take out the water container from the oven.

If your product is equipped with a pyro proof accessory (Resilient against self-cleaning at high temperatures), you do not need to remove these accessories from the oven.



2. Before starting the cleaning process, clean the exterior surfaces of the oven and the food remnants inside of it with a soapy cloth.

 Do not clean the door gasket. Fiberglass gasket is highly sensitive and can get damaged easily. If the door gasket is damaged, call the authorised service provider.

3. Touch  to switch on the oven.

4. Main menu will be displayed when the oven is switched on. Touch  /  until "**Extra Programs Menu**" is displayed.

5. Touch .

6. Touch  /  until "**Cleaning**" is displayed on the text display.

7. Touch .

8. Touch  to start cleaning. The self-cleaning time appears in the display. The duration cannot be changed. You can set the end time for the self-cleaning function.

9. Oven door cannot be opened and lock symbol  appears on the time display during self cleaning. Until the end of the cleaning process and the lock symbol disappears do not force the handle to unlock the door lock.

10. After the end of the cleaning process, remove white deposits with vinegar water.

### **Eco cleaning (pyrolytic self-cleaning - eco-pyrolysis) (This**

### **feature is optional. It may not exist on your product.)**



Hot surfaces cause burns! Do not touch the product during self-cleaning step and keep children away from it. Keep at least 30 minutes before removing the remnants.

If your oven is not heavily soiled we recommend the Eco cleaning function. If your oven is heavily soiled then the economical cleaning function will not be enough. In this case, perform cleaning in the "cleaning" mode.

1. Remove all accessories from the oven. For models with wire rack, remember to remove the wire rack. Do not forget to take out the water container from the oven.



If your product is equipped with a pyro proof accessory (Resilient against self-cleaning at high temperatures), you do not need to remove these accessories from the oven.

2. Before starting the cleaning process, clean the exterior surfaces of the oven and the food remnants inside of it with a soapy cloth.





Do not clean the door gasket. Fiberglass gasket is highly sensitive and can get damaged easily. If the door gasket is damaged, call the authorised service provider.



3. Touch  to switch on the oven.

4. Main menu will be displayed when the oven is switched on. Touch  /  until "**Extra Programs Menu**" is displayed.

5. Touch .









6. Touch  /  until "**Eco Cleaning**" is displayed on the text display.

7. Touch .

8. Touch  to start cleaning. The self-cleaning time appears in the display. The duration cannot be changed. You can set the end time for the self-cleaning function.
9. Oven door cannot be opened and lock symbol  appears on the time display during self cleaning. Until the end of the cleaning process and the lock symbol disappears do not force the handle to unlock the door lock.
10. After the end of the cleaning process, remove white deposits with vinegar water.









## Settings Menu

### Language setting

1. When the oven is powered for the first time, "Cooking Programs" message will be displayed on the text display.
2. Touch  /  until "Settings" is displayed on the text display.
3. Touch .
4. Touch  /  until "Language" is displayed on the text display.
5. Touch . The language that was initially set for the oven will be displayed.
6. Touch  /  to select the desired language.
7. Touch  to confirm the setting.









### Set the time

When the oven is powered for the first time, "00:00" will be set automatically. To change the time setting:









1. When the oven is switched on, "Cooking Programs" will be shown on the text display.
2. Touch  /  until "Settings" is displayed on the text display.
3. Touch .
4. Touch  /  until "Clock" is displayed on the text display.
5. Touch .
6. Touch  /  to set the current time.

7. Touch  to confirm the setting.









### Brightness setting

1. When the oven is powered for the first time, "Cooking Programs" message will be displayed on the text display.
2. Touch  /  until "Settings" is displayed on the text display.
3. Touch .
4. Touch  /  until "Brightness" is displayed on the text display.
5. Touch . The previously set brightness level will be displayed.
6. Touch  /  keys to select the desired level.
7. Touch  to confirm the setting.









### Volume setting

1. When the oven is powered for the first time, "Cooking Programs" message will be displayed on the text display.
2. Touch  /  until "Settings" is displayed on the text display.
3. Touch .
4. Touch  /  until "Volume" is displayed on the text display.
5. Touch . The previously set volume will be displayed.
6. Touch  /  keys to select the desired level.
7. Touch  to confirm the setting.



### Temperature unit setting



1. When the oven is powered for the first time, "Cooking Programs" message will be displayed on the text display.
2. Touch  /  until "Settings" is displayed on the text display.
3. Touch .
4. Touch  /  until "Temperature unit" is displayed on the text display.
5. Touch . The previously set temperature unit "C" will be displayed.
6.  Touch  keys to select "F".
7. Touch  to confirm the setting.

## Water hardness level setting



1. When the oven is powered for the first time, "Cooking Programs" message will be displayed on the text display.
2. Touch  /  until "Settings" is displayed on the text display.
3. Touch .
4. Touch  /  until "Water hardness" is displayed on the text display.
5. Touch . The previously set water hardness level will be displayed.
6. Touch  /  to select the level that is suitable for the hardness level of the water you use.
7. Touch  to confirm the setting.

## Auto drying setting

















1. When the oven is powered for the first time, "Cooking Programs" message will be displayed on the text display.
2. Touch  /  until "Settings" is displayed on the text display.
3. Touch .















4. Touch  until "Auto Drying" is displayed on the text display.
5. Touch . "On" will be displayed and the auto drying function will be activated.

## Cooking times table

-  The timings in this chart are meant as a guide. Timings may vary due to temperature of food, thickness, type and your own preference of cooking.
-  1st rack of the oven is the **bottom** rack.
-  The oven consumes nearly 1 liter of water in the water container during an average of 1 hour of cooking. Cooking processes exceeding 1 hour may require additional water. For cooking processes longer than 1 hour, please do not forget to follow the warnings given by your oven.

## Using the oven functions to cook

Dish	Cooking level number	Cooking function	Rack position	Temperature (°C)	Cooking time (approx. in min.)
Cakes in tray	One level		3	175	25 ... 35
Cakes in mould	One level		2	180	40 ... 50
Cakes in cooking paper	One level		3	175	20 ... 30
	2 levels		1 - 3	165	35 ... 45
	3 levels		1 - 3 - 5	165	40 ... 50
Sponge cake*	One level		3	175	10 ... 20
	2 levels		2 - 4	175	20 ... 30
Cookies	One level		3	175	25 ... 30
	2 levels		1 - 5	170 ... 190	30 ... 40
	3 levels		1 - 3 - 5	175	35 ... 45
Dough pastry	One level		2	200	30 ... 40
	2 levels		1 - 5	200	40 ... 50
Rich pastry	One level		2	200	25 ... 35
	2 levels		1 - 5	200	35 ... 45
	3 levels		1 - 3 - 5	190	45 ... 55
Leaven	One level		2	200	35 ... 45
	2 levels		1 - 3	190	35 ... 45

Dish	Cooking level number	Cooking function	Rack position	Temperature (°C)	Cooking time (approx. in min.)
Lasagna	One level		2	200	30 ... 40
Pizza	One level		2	200 ... 220	15 ... 20
	One level		3	200	10 ... 15
Pizza**	One level		1 - 2	310	4 ... 7
	One level		3	310	4 ... 7
Beef steak (whole) / Roast	One level		3	25 min. 250/max then 180 ... 190	100 ... 120
Leg of Lamb (casserole)	One level		3	25 min. 250/max then 190	70 ... 90
	One level		3	25 min. 250/max then 190	60 ... 80
Roasted chicken	One level		2	15 min. 250/max then 180 ... 190	60 ... 70
	One level		2	15 min. 250/max then 180 ... 190	70 ... 80
Turkey (5.5 kg)	One level		1	25 min. 250/max then 180 ... 190	150 ... 210
	One level		1	25 min. 250/max then 180 ... 190	150 ... 210
Fish	One level		3	200	20 ... 30
	One level		3	200	20 ... 30

When cooking on the 1st and 3rd racks at the same time, place the deeper tray on the lower rack and the other one on the upper rack.

When cooking on the 1st and 5th racks at the same time, place the deeper tray on the upper rack and the other one on the lower rack.

When cooking with 3 trays at the same time, place the deeper tray on the upper rack and the other one on the lower rack.

It is suggested to perform preheating for all foods.

\* It is suggested 26 cm diameter cake mould for sponge cake.

\*\* (310 °C) When a pizza stone – peel is used

## Steam cooking

Dish	Food weight (g)	Tray	Rack position	Cooking function	Temperature (°C)	Cooking time (approx. in min.)
Frozen peas	2600	Perforated tray + Oven tray	3	Steam cooking	100	30 ... 40
Frozen peas	1800 for one tray	Perforated tray + Oven tray	3 ... 5	Steam cooking	100	35 ... 45
Rib steak	1000	Perforated tray + Oven tray	3	Steam cooking	100	65 ... 75
Potato pieces	1000	Perforated tray + Oven tray	3	Steam cooking	100	30 ... 40
Chicken breast	1000	Perforated tray + Oven tray	3	Steam cooking	100	25 ... 35
Broccoli	1400	Perforated tray + Oven tray	3	Steam cooking	100	20 ... 30
Beef tenderloin	1000	Perforated tray + Oven tray	3	Steam cooking	100	50 ... 60
Fish	1000	Perforated tray + Oven tray	3	Steam cooking	100	20 ... 30
Courgette pieces	1000	Perforated tray + Oven tray	3	Steam cooking	100	25 ... 35
Cauliflower	1000	Perforated tray + Oven tray	3	Steam cooking	100	30 ... 40

Dish	Food weight (g)	Tray	Rack position	Cooking function	Temperature (°C)	Cooking time (approx. in min.)
Brussels sprouts	500	Perforated tray + Oven tray	3	Steam cooking	100	10 ... 20
Green beans	1000	Perforated tray + Oven tray	3	Steam cooking	100	25 ... 35
Carrot pieces	1000	Perforated tray + Oven tray	3	Steam cooking	100	20 ... 30
Rice	Water: 475 Rice: 180	Borosilicate glass cookware + Oven tray	3	Steam cooking	100	25 ... 35

1 - Do not preheat.  
2 - When cooking, place the oven tray to the 1st rack and the perforated tray to the 3rd rack.

## Eco Fan Heating

**i** do not change the cooking temperature after cooking starts in Eco Fan Heating mode.

**i** do not open the door in Eco Fan Heating mode. If you do not open the door, the inner temperature will be optimised to save energy and this temperature may be different from the one shown on the display.

Dish	Cooking level number		Rack position	Temperature (°C)	Cooking time (approx. in min.)
Cakes in cooking paper	One level		3	175	40 ... 50
Cookies	One level		3	180	25 ... 35
Dough pastry	One level		3	200	45 ... 55
Rich pastry	One level		3	200	35 ... 45

## How to operate the grill

**!** Close oven door during grilling. Hot surfaces may cause burns!



### Grilling without steam





1. Touch to switch on the oven.
2. Main menu will be displayed when the oven is switched on.
3. Touch to access the cooking programs menu.
4. Touch / to select the desired grill function without steam. Touch to activate the function.
5. If you would like to change the temperature, touch / when in the temperature/weight frame and set the desired temperature. The temperature value will be confirmed as soon as it is changed.

**i** The active field from Temperature/weight, Cooking time and Alarm time fields is surrounded by a frame. Touch to move the frame to the indication fields on the right, or touch to move it to the fields on the left. If you touch again when the frame is on the Temperature/weight display field on the left, the screen will return to the previous menu.

6. To set the cooking time, touch to move the frame to the Cooking time/cooking end time field. will be displayed. Touch / to set the desired cooking time.
7. To set the cooking end time to a later time, touch after setting the





cooking time.  will be displayed. Touch  /  to set the desired cooking end time.

8. **To set an alarm time without affecting the reminder**, touch  to move the frame to the Alarm time frame.  will be displayed. Touch  /  to set the desired alarm time. The alarm time is for reminding purposes, it does not affect the cooking time or functioning of the oven. For example, this is useful when you want to turn food in the oven at a certain point of time.

 Maximum alarm time can be 23 hours and 59 minutes.

9. If the cooking function, temperature, cooking time, cooking end time and the alarm time are suitable, touch  to start cooking. Cooking will start, and the display will show the set operating function and "Cooking" message respectively.

 Setting the cooking time, cooking and time and alarm time is not necessary for the oven to operate. It can be set optionally.











 If the oven door is opened during cooking,  symbol appears on the display.



» **If a cooking time has not been set;** the oven is operating manually. If your food is cooked, touch  to stop the oven. Otherwise, the oven will continue to operate.





» **If only a cooking time has been set;** the oven will stop at the end of the cooking time. The display will show the oven function and "Cooking is complete" message respectively. The oven will start to emit an audio warning. Touch any key to silence the audio warning.

» **If a cooking time and a cooking end time have been set;** the oven's clock will subtract the cooking time from the cooking end time you have set to calculate the cooking start time. When the cooking start time has come, the selected oven function will be activated and the oven will be heated to the set temperature. It maintains this temperature until the end of cooking time. The oven will stop at the end of the cooking time. The display will show the oven function and "Cooking is complete" message respectively. The oven will start to emit an audio warning. Touch any key to silence the audio warning.





### Steam assisted grilling





1. Touch  to switch on the oven.
2. Main menu will be displayed when the oven is switched on.
3. Touch  to access the cooking programs menu.
4. Touch  /  to select the desired steam assisted grilling function. Touch  to activate the function.
5. Touch . Use  /  to adjust the steam level. Touch  again to confirm the setting.
6. If you would like to change the temperature, touch  /  when in the temperature/weight frame and set the desired temperature. The temperature value will be confirmed as soon as it is changed.

**i** The active field from Temperature/weight, Cooking time and Alarm time fields is surrounded by a frame. Touch  to move the frame to the indication fields on the right, or touch  to move it to the fields on the left. If you touch  again when the frame is on the Temperature/weight display field on the left, the screen will return to the previous menu.

7. **To set the cooking time**, touch  to move the frame to the Cooking time/cooking end time field.  will be displayed. Touch  /  to set the desired cooking time.

This function does not allow you to start cooking before setting a cooking time. The cooking time is automatically set to 30 minutes on the display.

8. **To set the cooking end time to a later time**, touch  after setting the cooking time.  will be displayed. Touch  /  to set the desired cooking end time.

9. **To set an alarm time without affecting the reminder**, touch  to move the frame to the Alarm time frame.  will be displayed. Touch  /  to set the desired alarm time. The alarm time is for reminding purposes, it does not affect the cooking time or functioning of the oven. For example, this is useful when you want to turn food in the oven at a certain point of time.

**i** Maximum alarm time can be 23 hours and 59 minutes.

10. If the cooking function, temperature, cooking time, cooking end time and the alarm time are suitable, touch  to start cooking.

## 11. Steam function operating steps:

If you have not performed steam cooking for a long time, "Add clean water" message will be displayed.

12. Touch . The cover of the water container will open sideways and the water container will come out.



**i** In some models, the cover of water container will open frontways.

13. Take out the water container, empty the water in it (if any) and add clean water up to the "max." level at most.

**i** Risk for health! Do not use any other liquids apart from potable water in the steam system.

**i** Do not use distilled or filtered water. Use bottled water only. Do not add solutions that are inflammable, contain alcohol or solid particles into the water container.

**i** Thanks to the lid on the container, you can fill it without taking it out.

14. Place the container and touch  to close its cover. Touch  to start cooking.

» If the water level is suitable, cooking process will start.

**i** If the oven door is opened during cooking,  symbol appears on the display.

**i** If the water in the container is depleted during cooking, **"Please add water"** message will be displayed and the oven will emit an audio warning. Cooking will stop. Once you have re-filled the container with water and placed it into its housing again, the cooking cycle will continue where it left off.

» » **If only a cooking time has been set;** the oven will stop at the end of the cooking time. The display will show the oven function and **"Cooking completed"** message respectively. The oven will start to emit an audio warning. Touch any key to silence the audio warning.

» » **If a cooking time and a cooking end time have been set;** the oven's clock will subtract the cooking time from the cooking end time you have set to calculate the cooking start time. When the cooking start time has come, the selected oven function will be activated and the oven will be heated to the set temperature. It maintains this temperature until the end of cooking time. The oven will stop at the end of the cooking time. The display will show the oven function and **"Cooking completed"** message respectively. The oven will start to emit an audio warning. Touch any key to silence the audio warning.

15. At the end of the cooking cycle, discharge the remaining water in the container for reasons of hygiene.

**i** The water in the water generation system of the oven will be sent to the water container in about 15 minutes once the cooking is completed. Discharge this water remaining in the water container for reasons of hygiene.

16. Please activate the drying function for the water accumulated in the oven. See "Extras Menu".

**i** When the automatic drying function is active, it will automatically turn on at the end of each steam cooking cycle.

17. **To continue cooking:**  
**In 5 minutes after the cooking cycle has ended,** you can touch  to operate the oven with steam/steam assisted functions again.



» The oven will continue operating with the same cooking function and temperature setting.

18. If you want to operate the oven again **in 5 minutes after the cooking cycle has been completed,** the message **"Oven is getting ready"** will be displayed since the oven will have started to send the water in the steam generation system back to the water container. Once this message has disappeared, you can touch  to start cooking. Since the water in the water generation system has been sent to the water container, **"Add clean water"** message will be displayed.

19. Touch . The cover of the water container will open sideways and the water container will come out.

**i** In some models, the cover of water container will open frontways.

20. Take out the water container, empty the water in it (if any) and add clean water up to the "max." level at most.

21. Place the container and touch  to close its cover. Touch  to start cooking.

» If the water level is suitable, cooking process will start.

**i** If you open the oven door while a steam function is running, the fan motor will run at high speed to create an air curtain.

**i** During the last 3 minutes of steam cooking, the fan motor will run at high speed to reduce steam density in the oven.

22. At the end of the cooking cycle, discharge the remaining water in the container for reasons of hygiene.

**i** The water in the water generation system of the oven will be sent to the water container in about 15 minutes once the cooking is completed. Discharge this water remaining in the water container for reasons of hygiene.

23. Please activate the drying function for the water accumulated in the oven. See "Extras Menu".

**i** When the automatic drying function is active, it will appear on the oven display at the end of each steam cooking process. You can touch  to start it.

**i** Before starting the drying function, take out the food and accessories such as trays, wire grills, etc. from the oven.



Foods that are not suitable for grilling carry the risk of fire. Only grill food which is suitable for intensive grilling heat.

Do not place the food too far in the back of the grill.

This is the hottest area and fatty food may catch fire.

### Cooking times table for grilling

#### Grilling with electric grill

Food	Accessory to use	Rack position	Recommended temperature (°C)**	Cooking time (approx. in min.)
Fish	Wire grill	4...5	250	20...25 min. #
Sliced chicken	Wire grill	4...5	250	25...35 min.
Lamb chops	Wire grill	4...5	250	20...25 min.
Roast beef	Wire grill	4...5	250	25...30 min. #
Veal chops	Wire grill	4...5	250	25...30 min. #
Toast bread*	Wire grill	4	250	1...3 min.

# depending on thickness

\*Preheat for 5 minutes

\*\*If the grill temperature of your product cannot be adjusted, the grill will work at the recommended temperature.

Meals in this cooking table are prepared according to EN 60350-1 to make it easier for control institutes to test the product

Food	Accessory to use	Rack position	Temperature (°C)	Cooking time (approx. in min.)
Toast bread	Wire grill	4	250	1...3 min.
Meatballs (beef) - 12 pieces	Wire grill	4	250	25...35 min.

Turn the food after 2/3 of the total grilling time.

It is suggested to perform 5 minutes preheating for all foods broiling.

## 6 Maintenance and care

### General information

Service life of the product will extend and the possibility of problems will decrease if the product is cleaned at regular intervals.



Disconnect the product from mains supply before starting maintenance and cleaning works. There is the risk of electric shock!



Allow the product to cool down before you clean it. Hot surfaces may cause burns!

- Clean the product thoroughly after each use. In this way it will be possible to remove cooking residues more easily, thus avoiding these from burning the next time the appliance is used.
- No special cleaning agents are required for cleaning the product. Use warm water with washing liquid, a soft cloth or sponge to clean the product and wipe it with a dry cloth.
- Always ensure any excess liquid is thoroughly wiped off after cleaning and any spillage is immediately wiped dry.
- Do not use cleaning agents that contain acid or chloride to clean the stainless or inox surfaces and the handle. Use a soft cloth with a liquid detergent (not abrasive) to wipe those parts clean, paying attention to sweep in one direction.



The surface might get damaged by some detergents or cleaning materials.



Do not use aggressive detergents, cleaning powders/creams or any sharp objects during cleaning. Do not use harsh abrasive cleaners or sharp metal scrapers to clean the oven door glass since they can scratch the surface, which may result in shattering of the glass.



Do not use steam cleaners to clean the appliance as this may cause an electric shock.

### Cleaning the water container

The water container is found behind the cover on the left side of the control panel. To remove and clean:

1. Touch . The cover of the water container will open sideways and the water container will come out.
2. Take out the water container and clean it under running water.
3. After cleaning, place the container and touch  to close its cover.



Do not use chemical materials when cleaning the water container. Use only water.



Never wash the container in dishwasher.

### Cleaning the control panel

Clean the control panel and knobs with a damp cloth and wipe them dry.

- i** If your product is equipped with buttons/knobs do not remove the control buttons/knobs to clean the control panel.  
Control panel may get damaged!

## Cleaning the oven

**To clean the side wall (Varies depending on the product model.)**  
(This feature is optional. It may not exist on your product.)

1. Remove the front section of the side rack by pulling it in the opposite direction of the side wall.
2. Remove the side rack completely by pulling it towards you.

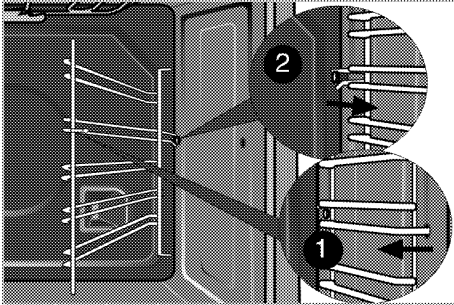

**To clean the side wall (Varies depending on the product model.)**  
(This feature is optional. It may not exist on your product.)

1. Remove the screw on the front section of the side rack as shown in the figure below
2. Remove the side rack completely by pulling it towards you.

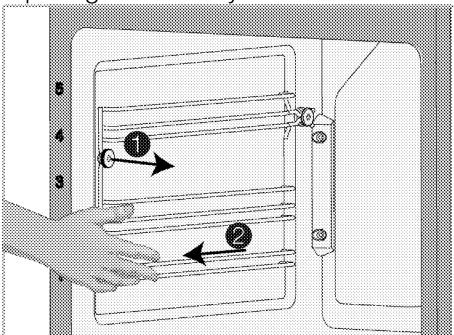

## Catalytic walls

(This feature is optional. It may not exist on your product.)

The inner side walls (A) and/or the rear wall (B) of your product may be coated with catalytic enamel. Catalytic walls have a light matte colour and a porous surface. Catalytic walls of the oven should not be cleaned. Thanks to their perforated structure, catalytic surfaces absorb grease and once the surface is filled with grease, they start to shine. In this case, it is recommended to replace the parts.

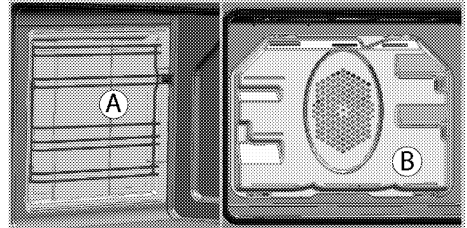

## Clean oven door

To clean the oven door, use warm water with washing liquid, a soft cloth or sponge to clean the product and wipe it with a dry cloth.

- i** Don't use any harsh abrasive cleaners or sharp metal scrapers for cleaning the oven door. They could scratch the surface and destroy the glass.

## Removing the oven door

1. Open the front door (1).
2. Open the clips at the hinge housing (2) on the right and left hand sides of the front door by pushing on the hook as illustrated in the figure. The lock should look like (4) when it is open.

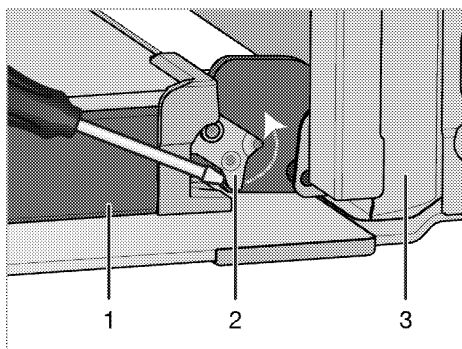

- 1 Door
- 2 Hinge lock(closed position)
- 3 Oven
- 4 Hinge lock(open position)

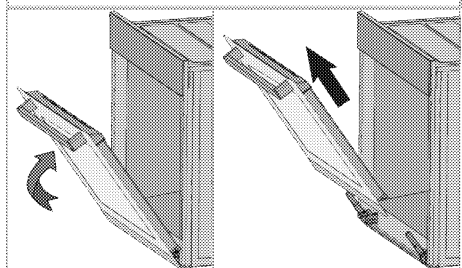
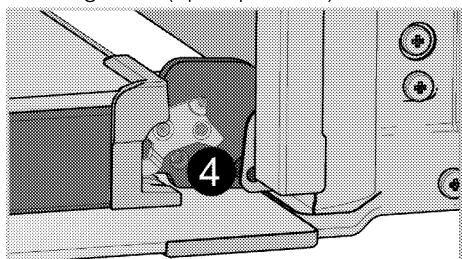

3. Move the front door to half-way.
4. Remove the front door by pulling it upwards to release it from the right and left hinges.

**i** Steps carried out during removing process should be performed in reverse order to install the door. Do not forget to close the clips at the hinge housing when reinstalling the door.

### **Soft Open & Soft Close feature**

Some models may include a Soft Close & Soft Open feature. Soft Close feature allows the user to close an oven door smoothly by bringing it to about 15 cm from the closed position and gently pushing it. The automatic damper system helps close the door softly. A similar feature is observed while the oven door is fully opened; About 9 cm from the fully open position the damper system kicks in and allows gentle opening.

### **Replacing the oven lamp**

For product safety, the oven lamp must not be removed by the user. In case of any lamp failure, notify the authorized service and have it replaced.

## 7 Troubleshooting

### **Oven emits steam when it is in use.**

- It is normal that steam escapes during operation. >>> *This is not a fault.*

### **Product emits metal noises while heating and cooling.**

- When the metal parts are heated, they may expand and cause noise. >>> *This is not a fault.*

### **When steam cooking is completed, the water pump noise comes from the product.**

- The water pump can make a noise when the oven takes back the water in the tank. >>> *This is not a fault.*

### **Product does not operate.**

- The mains fuse is defective or has tripped. >>> *Check fuses in the fuse box. If necessary, replace or reset them.*
- Product is not plugged into the (grounded) socket. >>> *Check the plug connection.*

### **Oven light does not work.**

- Oven lamp is defective. >>> *Replace oven lamp.*
- Power is cut. >>> *Check if there is power. Check the fuses in the fuse box. If necessary, replace or reset the fuses.*

### **Oven does not heat.**

- Might not be set to a certain cooking function and/or temperature. >>> *Set the oven to a certain cooking function and/or temperature.*
- Power is cut. >>> *Check if there is power. Check the fuses in the fuse box. If necessary, replace or reset the fuses.*

**i** Consult the Authorised Service Agent or technician with licence or the dealer where you have purchased the product if you can not remedy the trouble although you have implemented the instructions in this section. Never attempt to repair a defective product yourself.



Envelope III





