



Mašina za pranje rublja

Priručnik za korisnika

Washing Machine

User's Manual



WUE6511XWW

SB/EN



1 Opšta bezbednosna uputstva

Ovaj odeljak obuhvata bezbednosna uputstva koja vam mogu pomoći da sprečite povrede i rizike od oštećenja materijala. Sve vrste garancija neće važiti ako se ova uputstva ne poštuju.

1.1 Lična i bezbednost svojine

- ▶ Nikad ne stavljajte proizvod na pod pokriven tepihom. Električni delovi će se pregrejati pošto vazduh ne može da cirkuliše sa donje strane uređaja. To može da prouzrokuje probleme sa vašim proizvodom.
- ▶ Izvadite strujni utikač kada proizvod nije u upotrebi.
- ▶ Sve radove na instalaciji i popravci uvek prepustite ovlašćenom serviseru. Proizvođač neće biti odgovoran za oštećenja do kojih može da dođe kada takve radove obavljaju neovlašćena lica.
- ▶ Creva za dovod i ispuštanje vode uvek moraju da budu dobro učvršćena i neoštećena. Inače može da dođe do isticanja vode.
- ▶ Dok još uvek ima vode unutar proizvoda, nikada nemojte da otvarate vrata za ubacivanje ili da vadite filter. U suprotnom će postojati opasnost od poplave i povreda zbog vruće vode.
- ▶ Nikada nemojte na silu da otvarate zaključana vrata za punjenje veša. Vrata se mogu otvoriti nekoliko minuta nakon završetka ciklusa pranja. U slučaju da se vrata za punjenje veša silom otvaraju može doći do oštećivanja vrata i mehanizma zaključavanja.
- ▶ Koristite samo deterdžente, omekšivače i dodatke koji se upotrebljavaju za mašinsko pranje.
- ▶ Pratite uputstva na etiketi odeće i pakovanju deterdženta.

1.2 Bezbednost dece

- ▶ Ovaj proizvod mogu da koriste deca starosti 8 godina i više kao i osobe sa nepotpuno razvijenim telesnim, senzornim i mentalnim sposobnostima, kao i osobe koje nemaju dovoljno potrebnog iskustva i znanja sve dok su pod nadzorom ili su prošli obuku u vezi sa bezbednom upotrebom proizvoda i rizicima. Deca ne treba da se igraju sa ovim uređajem. Čišćenje i održavanje nikad ne smeju obavljati deca, osim pod nečijim nadzorom. Deca mlađa od 3 godine ne treba da se približavaju osim ako nisu pod neprekidnim nadzorom.

- ▶ Materijali pakovanja mogu biti opasni po decu. Ambalažne materijale čuvajte na sigurnom mestu, van domašaja dece.
- ▶ Električni proizvodi su opasni po decu. Držite decu dalje od proizvoda dok se koristi. Ne dajte im da se igraju ovim proizvodom. Koristite funkciju zaključavanja zbog dece da biste sprečili da deca manipulišu ovim proizvodom.
- ▶ Nemojte zaboraviti da zatvorite vrata za punjenje veša kada napuštate prostoriju u kojoj se nalazi ovaj proizvod.
- ▶ Držite sve deterdžente i aditive na sigurnom mestu, dalje od domašaja dece i zatvarajte poklopac posude sa deterdžentom ili zapečatite pakovanje deterdženta.

1.3 Električna bezbednost

- ▶ U slučaju da je proizvod u kvaru, ne sme da se uključuje dok ga ne popravi ovlašćeni serviser. Rizik od strujnog udara!
- ▶ Ovaj proizvod je projektovan tako da nastavi da radi u slučaju ponovnog uspostavljanja napajanja posle nestanka struje. Ako želite da otkazete program, pogledajte deo „Otkazivanje programa“.
- ▶ Priključite proizvod na uzemljenu utičnicu zaštićenu osiguračem od 16 A. Neka Vam instalaciju uzemljenja uradi kvalifikovani električar. Naša firma neće biti odgovorna za bilo kakva oštećenja do kojih može da dođe kad se proizvod koristi bez uzemljenja u skladu sa lokalnim propisima.
- ▶ Nemojte da perete proizvod prskanjem ili prosipanjem vode na njega! Rizik od strujnog udara!
- ▶ Nikada nemojte da dodirujete kablove za napajanje vlažnim rukama! Nemojte da držite kabl za napajanje da biste ga izvukli iz utičnice, uvek ga izvlačite iz utičnice držeći utičnicu jednom rukom i povlačeći utikač drugom rukom.
- ▶ Proizvod treba da se isključi iz struje za vreme instalacije, održavanja, čišćenja i popravke.
- ▶ Ukoliko se kabl za napajanje ošteti, mora da ga zameni proizvođač, serviser ili slično kvalifikovano lica (po mogućstvu električar) ili osoba koju je odredio uvoznik da bi se izbegli mogući rizici.

1.4 Bezbednost u vezi sa vrelim površinama

| | |
|---|--|
|  | <p>Staklo na vratima mašine je vruće kada se veš pere na visokim temperaturama. S obzirom na ovu činjenicu, tokom pranja decu držite podalje od vrata za ubacivanje veša na proizvodu da biste sprečili da ih dodirnu.</p> |
|---|--|

2 Važna uputstva za zaštitu životne sredine

2.1 Usaglašenost sa WEEE direktivom



Ovaj proizvod je usaglašen sa WEEE direktivom Evropske Unije (2012/19/EU). Ovaj proizvod nosi znak klasifikacije za električni i elektronski otpad (WEEE).

Ovaj proizvod je proizveden korišćenjem visokokvalitetnih delova i materijala koji se mogu ponovo iskoristiti ili su pogodni za reciklažu. Nemojte odlagati proizvod u otpad sa običnim kućnim otpadom i drugim otpadima na kraju veka trajanja. Odložite ga u centar za sakupljanje i reciklažu električnog i elektronskog otpada. Konsultujte se sa svojim lokalnim vlastima da biste saznali o ovim centrima za sakupljanje otpada.

Usaglašenost sa RoHS direktivom:

Proizvod koji ste kupili u saglasnosti je sa RoHS direktivom Evropske unije (2011/65/EU). On ne sadrži štetne i zabranjene materijale navedene u direktivi.

2.2 Informacije o pakovanju

Ambalažni materijali ovog proizvoda su proizvedeni od materijala koji se recikliraju u skladu sa nacionalnim propisima o zaštiti životne sredine. Ambalažne materijale ne odlažite zajedno sa kućnim ili drugim otpadima. Odnosite ih na mesta za prikupljanje ambalažnog materijala određena od strane lokalne vlasti.

3 Namena

- Ovaj proizvod je dizajniran za upotrebu u domaćinstvu. Nije namenjen za komercijalnu upotrebu i ne treba ga koristiti van svoje namene.
- Ovaj proizvod sme da se koristiti samo za pranje i ispiranje veša prema njihovim etiketama.
- Proizvođač ne prihvata odgovornost koja proističe iz nepravilne upotrebe ili prenosa.
- Radni vek vašeg uređaja je 10 godina. Tokom ovog perioda će biti dostupni originalni rezervni delovi koji će omogućiti pravilan rad uređaja.

4 Tehničke specifikacije

| | |
|---|--------------|
| Visina (cm) | 84 |
| Širina (cm) | 60 |
| Dubina (cm) | 44 |
| Neto težina (±4 kg) | 55 |
| Jednostruki dovod vode / Dvostruki dovod vode | • / - |
| • Dostupno | |
| Napon napajanja (V/Hz) | 230 V / 50Hz |
| Ukupna struja (A) | 10 |
| Ukupna snaga (W) | 1550 |
| Šifra glavnog modela | 9213 |

Ispunjavanje propisa Komisije (EU) br. 1061/2010

| | |
|---|-------------------------|
| Naziv dobavljača ili zaštitni znak | Beko |
| Naziv modela | WUE 6511 XWW |
| Nominalni kapacitet (kg) | 6 |
| Klasa energetske efikasnosti / skala od A+++ (najviša efikasnost) do D (najniža efikasnost) | A+++ |
| Godišnja potrošnja energije (kWh) ⁽¹⁾ | 152 |
| Potrošnja energije na standardnom programu na 60 °C pri potpunom punjenju (kWh) | 0,918 |
| Potrošnja energije na standardnom programu na 60 °C pri delimičnom punjenju (kWh) | 0,490 |
| Potrošnja energije na standardnom programu na 40 °C pri delimičnom punjenju (kWh) | 0,485 |
| Potrošnja energije u „isključenom režimu“ (W) | 0,250 |
| Potrošnja energije u „režimu ostavljanja“ (W) | 0,750 |
| Godišnja potrošnja vode (l) ⁽²⁾ | 8799 |
| Klasa efikasnosti sušenja centrifugom / skala od A (najviša efikasnost) do G (najniža efikasnost) | C |
| Maksimalna brzina obrtaja (opm) | 1000 |
| Sadržaj preostale vlage (%) | 62 |
| Standardni program za pamuk ⁽³⁾ | Pamuk eko 60 °C i 40° C |
| Vreme standardnog programa na 60 °C pri potpunom punjenju (min) | 255 |
| Vreme standardnog programa na 60 °C pri delimičnom punjenju (min) | 205 |
| Vreme standardnog programa na 40 °C pri delimičnom punjenju (min) | 205 |
| Trajanje režima ostavljanja (min) | N/A |
| Nivo akustične buke koja se prenosi vazduhom prilikom pranja/obrtanja (dB) | 63/75 |
| Ugrađeno | Non |

⁽¹⁾ Potrošnja energije je zasnovana na 220 ciklusa standardnog pranja u programima za pamuk na 60 °C i 40 °C pri potpunom i delimičnom punjenju, i potrošnji u režimima za uštedu energije. Stvarna potrošnja energije će zavisi od načina upotrebe uređaja.

⁽²⁾ Potrošnja vode je zasnovana na 220 ciklusa standardnog pranja u programima za pamuk na 60 °C i 40 °C pri potpunom ili delimičnom punjenju. Stvarna potrošnja vode će zavisi od načina upotrebe uređaja.

⁽³⁾ „Standardni program za pamuk na 60 °C“ i „standardni program za pamuk na 40 °C“ su standardni programi za pranje na koje se podaci na etiketi i deklaraciji odnose i ovi programi su pogodni za pranje normalno zaprjanog pamučnog veša i to su najefikasniji programi kada je reč o kombinovanoj potrošnji energije i vode.

4.1 Instalacija

- Zatražite pomoć u vezi sa instalacijom proizvoda od najbližeg ovlašćenog servisa.
- Priprema lokacije i priključaka za struju, vodovod i kanalizaciju na mestu instalacije proizvoda su odgovornost kupca.
- Pazite da se creva za dovod i odvod vode, kao i električni kabl, ne savijaju, uklješte ili prignječe prilikom postavljanja proizvoda na mesto posle instalacije i procedura čišćenja.
- Postarajte se da instalacija i električno priključivanje proizvoda bude obavljeno od strane ovlašćenog servisa. Proizvođač neće biti odgovoran za oštećenja do kojih može da dođe kada takve radove obavljaju neovlašćena lica.
- Pre instalacije vizuelno proverite da li na njemu postoje oštećenja. Ako postoje, nemojte ga instalirati. Oštećeni proizvodi predstavljaju opasnost za vašu bezbednost.

4.1.1 Odgovarajuće mesto za instalaciju

- Postavite proizvod na čvrst i ravan pod. Nemojte da ga stavljate na deo tepih ili druge slične površine.
- Kada se mašina za veš i sušenje postave jedna iznad druge, njihova ukupna težina - kada su napunjene vešom - dostiže 180 kilograma. Proizvod postavite na čvrst i ravan pod koji ima dovoljnu nosivost!
- Ne stavljajte proizvod na strujni kabl.
- Nemojte da stavljate proizvod u okruženja gde temperatura pada ispod 0 °C.
- Preporučuje se da se na stranama mašine ostavi zazor da bi se smanjile vibracije i buka
- Kod poda na više nivoa, nemojte da stavljate proizvod blizu ivice ili na platformu.
- Nemojte da postavljate izvore toplote, kao što su ploče za kuvanje, pegle, rerne itd. na mašinu za pranje i nemojte da ih koristite na proizvodu.

4.1.2 Uklanjanje pojačanja pakovanja



Nagnite mašinu unazad da biste uklonili pojačanja pakovanja. Uklonite pojačanje pakovanja povlačenjem trake. Nemojte sami da obavljate ovu radnju.

4.1.3 Uklanjanje transportnih brava

- 1 Olabavite sve zavrtnjaje odgovarajućim ključem dok se slobodno ne okreću.
- 2 Sklonite sigurnosne zavrtnjaje za trasport tako što ćete ih polako okrenuti.
- 3 Ubacite plastične poklopce iz kese sa korisničkim uputstvom u otvore na zadnjoj strani.

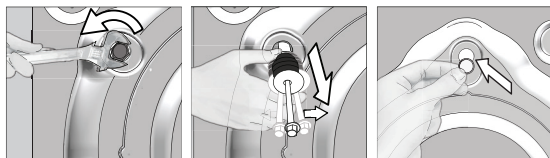

PAŽNJA: Uklonite transportne bezbednosne vijke pre uključivanja mašine za pranje veša! U suprotnom se proizvod može oštetiti.



Držite transportne bezbednosne vijke na sigurnom mestu da biste ih mogli ponovo koristiti kad se mašina bude jednom ponovo prenosila.

Postavite transportne bezbednosne vijke u obrnutom redosledu u odnosu na proceduru rastavljanja.

Nikad ne pomerajte proizvod bez montiranih bezbednosnih vijaka!

4.1.4 Povezivanje dovoda vode



Pritisak dovoda vode potreban da bi mašina radila mora da bude od 1 do 10 bara (0,1 – 1 MPa). Morate da imate 10 – 80 litara vode koja teče iz potpuno otvorene slavine u jednom minutu da bi mašina radila kako treba. Dodajte ventili za smanjivanje pritiska ako je pritisak vode prejak.



PAŽNJA: Modeli sa jednostrukim dovodom vode ne smeju da se spajaju na slavinu sa toplom vodom. U tom slučaju će se oštetiti veš ili će proizvod uključiti zaštitu i neće raditi.

PAŽNJA: Ne koristite stara ili korišćena creva za dovod vode na novom proizvodu. To može da prouzrokuje fleke na vašem vešu.

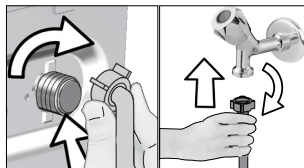

- 1 Zategnite matice creva rukom. Nikad ne koristite alat za pritezanje ovih navrtki.
- 2 Kada se priključivanje creva završi, proverite da li ima curenja na mestima povezivanja tako što ćete slavine otvoriti u potpunosti. Ako curi, zatvorite slavinu i uklonite navrtku. Proverite zaptivač i ponovo pažljivo pritegnite navrtku. Da biste sprečili curenja vode i oštećenje, slavine držite zatvorene kada ne koristite proizvod.

4.1.5 Povezivanje odvodnog creva sa odvodnim otvorom

- Prkličite kraj creva direktno na kanalizacionu cev, odvod lavbora ili kade.



PAŽNJA: Vaša kuća može da bude poplavljena ako crevo izađe iz kućišta za vreme izbacivanja vode. Osim toga, postoji opasnost od opekotina zbog visokih temperature pranja! Da biste sprečili takve situacije i postarali se da mašina obavlja procese prihvatanja i odvoda vode bez problema, pričvrstite crevo za odvod čvrsto.

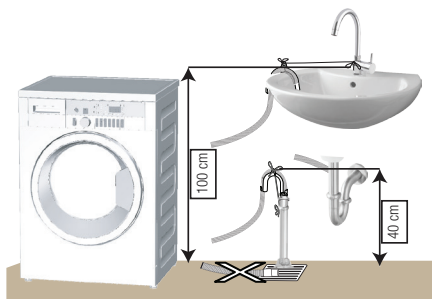

- Prkličite crevo za odvod minimalne dužine 40 cm a maksimalne dužine 100 cm.
- U slučaju da je crevo za odvod dignuto posle stajanja na podu ili blizu poda (manje od 40 cm iznad zemlje), ispuštanje vode postaje teže i veš može da izađe mokrak. Zato treba da se držite visina opisanih na slici.

- Da biste sprečili vraćanje prljave vode u mašinu i obezbedili jednostavno odvođenje, nemojte da potapate kraj creva u prijavu vodu i nemojte da ga ubacujete u odvodni otvor više od 15 cm. Ako je previše dugačko, skratite ga.
- Kraj creva ne sme da se savija i ne sme da se gazi, a crevo se ne sme ukleštiti između odvoda i mašine.
- Ako je dužina creva prekratka, produžite ga originalnim dodatnim crevom. Dužina creva ne sme da bude veća od 3,2 m. Da biste izbegli probleme sa curenjem vode, veza između produžnog creva i odvodnog creva na proizvodu mora da bude pričvršćena dobro odgovarajućom stegom tako da ne dođe do spadanja i curenja.

4.1.6 Podešavanje nožica



PAŽNJA: Da bi osigurali tiši rad proizvoda bez vibracija, on mora da stoji ravno i u ravnoteži na svojim nožicama. Uravnotežite mašinu podešavanjem nožica. U suprotnom se može desiti da se proizvod pomera sa svog mesta i izazove probleme sa vibracijama i lomovima.

PAŽNJA: Ne koristite nikakve alate za popuštanje blokirajućih navrtki. U suprotnom se mogu oštetiti.

- 1 Rukom otpustite blokirajuće navrtke na nožicama.
- 2 Podesite nožice dok proizvod bude mogao da stoji stabilno i balansirano.
- 3 Sve blokirajuće navrtke pritegnite ručno.

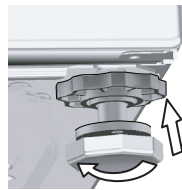
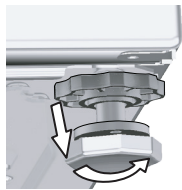

4.1.7 Povezivanje struje

Proizvod priključite na uzemljenu utičnicu koja je zaštićena osiguračem od 16 A. Naša firma neće biti odgovorna za bilo kakva oštećenja do kojih može da dođe kad se proizvod koristi bez uzemljenja u skladu sa lokalnim propisima.

- Povezivanje mora da bude obavljeno prema nacionalnim standardima.
- Ožičenje kola električne utičnice mora da bude dovoljno tako da zadovolji zahteve uređaja. Korišćenje osigurača za slučaj neispravnog uzemljenja je preporučeno.
- Utikač kabla za napajanje mora da bude pristupačan nakon instalacije.
- Ako je trenutna vrednost osigurača u Vašoj kući manja od 16 ampera, neka vam električar ugradi osigurač od 16 ampera.
- Napon naveden u "Tehničkim specifikacijama" mora da bude jednak naponu vaše električne mreže.
- Ne priključivati preko produžnih kablova ili razvodnika.



PAŽNJA: Oštećeni strujni kabl mora zameniti ovlašćeni električar.

4.1.8 Prva upotreba



Pre početka korišćenja proizvoda, proverite da li su sve pripreme u skladu sa odeljkom „Važna uputstva vezana za bezbednost i životnu sredinu“ i uputstvima iz odeljka „Instalacija“.

Da biste pripremili proizvod za pranje veša, prvo uključite program za čišćenje doboša. Ako ovaj program nije dostupan na vašoj mašini, koristite metod koji je opisan u odeljku 4.4.2.



Koristite sredstvo za uklanjanje kamenca koje je podesno za mašine za pranje veša.

U proizvodu je možda ostalo malo vode iz procesa kontrole kvaliteta u proizvodnji. To ne šteti proizvodu.

4.2 Priprema

4.2.1. Sortiranje veša

- * Sortirajte veš prema vrsti tkanine, boji, prema tome koliko je prljav i prema dozvoljenoj temperaturi vode.
- * Uvek se držite uputstava koja su navedena na etiketama odeće.

4.2.2 Priprema veša za pranje

- Veš sa metalnim dodacima kao što su brushalteri, kopolče kaiša i metalna dugmad mogu da oštete mašinu. Uklonite metalne dodatke ili operite takav veš tako što ćete ga staviti u vreću za veš ili jastučnicu.
- Izvadite sve stvari iz džepova, kao što su novčići, olovke i spajalice, izvrtne džepove naopačke i iščetkajte ih. Takvi objekti mogu da oštete proizvod ili da izazovu problem sa bukom.
- Odeću male veličine, kao što su dečije sokne i najlon čarape, stavite u vreću za veš ili jastučnicu.
- Zavesu stavljajte tako da ih ne pritiskate. Uklonite dodatke sa zavesa.
- Zatvorite rajsferšluse, zašijte dugmad koja visi i ušijte pocepano.
- Perite proizvode označene sa "pere se u mašini" ili "pere se na ruke" samo na odgovarajućem programu.
- Ne perite beli i obojeni veš zajedno. Novi tamni pamučni veš može da ispusti puno boje. Perite ih posebno.
- Uporne fleke se moraju pravilno obraditi pre pranja. Ako niste sigurni, raspitajte se u radnji za hemijsko čišćenje.
- Koristite samo sredstva za boje koja odgovaraju mašinskom pranju. Uvek se držite uputstava na pakovanju.
- Pantalone i osetljivo rublje perite izvrtno naopačke.
- Komade odeće od angore držite u frižideru nekoliko sati pre pranja. To će smanjiti ćebanje.
- Veš koji je bio izložen materijama kao što su brašno, prašina, mleko u prahu itd. mora dobro da se istrese pre stavljanja u mašinu. Takve prašine i praškovi na vešu mogu da se natalože u unutrašnjosti mašine tokom vremena i izazovu oštećenje.

4.2.3 Za uštedu energije

Sledeće informacije će vam pomoći da ovaj proizvod koristite na ekološki i energetski efikasan način.

- Proizvod koristiti za najveći kapacitet koji dozvoljava izabrani program, ali ne preopterećujte mašinu; pogledajte "Tabelu programa i korišćenja". Pogledajte "Tabelu programa i korišćenja"
- Uvek se držite uputstava sa pakovanja deterdženta.
- Malo prljav veš perite na niskim temperaturama.
- Koristite brže programe za male količine ili malo prljav veš.
- Ne koristite pretpranje i visoke temperature za veš koji nije mnogo prljav ili isflekan.
- Ako planirate da sušite veš u mašini za sušenje veša, izaberite najveću brzinu centrifuge koja je preporučena za proces pranja.
- Nemojte da koristite više deterdženta nego što je preporučeno na njegovom pakovanju.

4.2.4 Stavljanje veša

1. Otvorite poklopac za veš.
2. Stavite delove odeće u mašinu bez nabijanja.
3. Gurnite i zatvorite poklopac dok ne začujete zvuk zaključavanja. Pazite da vrata ništa ne zahvate. Vrata za punjenje su zaključana dok je program u toku. Vrata se mogu otvoriti samo posle završetka programa.

4.2.5 Odgovarajući kapacitet punjenja

Maksimalni kapacitet punjenja zavisi o vrsti veša, o tome koliko je prljav i koji program želite da koristite. Mašina automatski podešava količinu vode na osnovu težine stavljenog veša.



UPOZORENJE: Držite se informacija iz „Tabele programa i potrošnje“. Ako je preopterećena, rezultati pranja mašine biće slabiji. Štaviše, mogu se javiti problemi sa bukom i vibriranjem.

4.2.6 Korišćenje deterdženta i omekšivača



Kada se koristi deterdžent, omekšivač, štirak, boja za tkaninu, izbeljivač ili sredstvo za uklanjanje boje, pažljivo pročitajte uputstvo proizvođača na pakovanju i držite se navedenih vrednosti za doziranje. Koristite čašicu za merenje ako postoji.

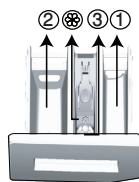

Fioka za deterdžent se sastoji od 3 odeljka:

- (1) za pretpranje
- (2) za glavno pranje
- (3) za omekšivač
- (⊗) osim toga, postoji sifonski deo u odeljku za omekšivač.

Deterdžent, omekšivači i druga sredstva za pranje

- Dodajte deterdžent i omekšivač pre pokretanja programa pranja.
- Dok je ciklus pranja u toku, nemojte da ostavljate fioku za deterdžent otvorenu!
- Kada koristite program bez pretpranja, ne stavljajte deterdžent u odeljak za pretpranje (odeljak br. "1").
- Kod programa sa pretpranjem ne stavljajte tečni deterdžent u odeljak za pretpranje (odeljak br. "1").
- Ne birajte program sa pretpranjem ako koristite kesu s deterdžentom ili kuglu za raspršivanje. Stavite kesu s deterdžentom ili kuglu za raspršivanje u mašinu, direktno među vešom.

Ako koristite tečni deterdžent, nemojte zaboraviti da posudu sa tečnim deterdžentom stavite u odeljak za glavno pranje (odeljak broj „2“).

Izbor vrste deterdženta

Tip deterdženta koji treba koristiti zavisi od vrste i boje tkanine.

- Koristite različite deterdžente za beli veš i veš u boji.
- Osetljivu odeću perite specijalnim deterdžentima (tečni deterdžent, šampon za vunu itd.) koji se koriste isključivo za osetljivu odeću.
- Kada perete odeću tamnije boje i kiltove, preporučuje se korišćenje tečnog deterdženta.
- Vunene stvari perite specijalnim deterdžentom koji je namenjen za vunu.



PAŽNJA: Koristite samo deterdžente proizvedene specijalno za mašinsko pranje.

PAŽNJA: Nemojte da koristite sapun u obliku pudera.

Podešavanje količine deterdženta

Količina deterdženta koja će da se koristi zavisi od količine veša, od toga koliko je prljav i od tvrdoće vode.

- Nemojte da koristite količine koje prelaze doze preporučene na pakovanju da biste izbegli problem sa previše pene, lošim ispiranjem, finansijskom uštedama i, na kraju, zaštitom okoline.
- Koristite manje deterdženta za male količine veša ili za malo prljav veš.

Korišćenje omekšivača

Sipajte omekšivač u odeljak za omekšivač fiokice za deterdžent.

- Nemojte da pređete znak (>max<) na odeljku za omekšivač.
- Ako je omekšivač izgubio tečnost, razblažite ga vodom pre nego što ga stavite u fioku za deterdžent.

Korišćenje tečnih deterdženata

Ako proizvod sadrži šolju za tečni deterdžent:

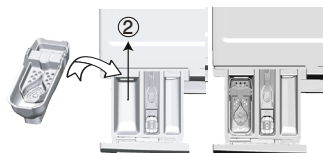

- Stavite posudu za tečni deterdžent u odeljak br. „2“.
- Ako je tečni deterdžent izgubio svoju tečnost, razblažite ga vodom pre stavljanja u posudu za deterdžent.

Ako je proizvod opremljen delom za tečni deterdžent:

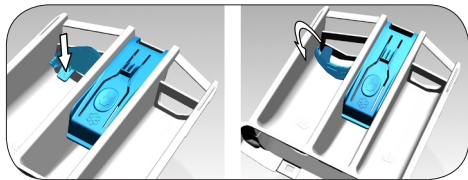

- Kada želite da koristite tečni deterdžent, pritisnite prikazanu tačku da biste rotirali aparat. Deo koji ispadne će funkcionisati kao graničnik za tečni deterdžent.
- Ako je neophodno, očistite aparat vodom kada je u odgovarajućem položaju ili tako što ćete ga ukloniti.
- Ako koristite deterdžent u prahu, aparat mora da bude pričvršćen u gornjem položaju.

Ako proizvod ne sadrži šolju za tečni deterdžent:

- Ne koristite tečni deterdžent za pretpranje u programima sa pretpranjem.
- Tečni deterdžent ostavlja fleke na vašoj odeći ako se koristi sa funkcijom odloženog početka. Ako hoćete da koristite funkciju odloženog početka, ne koristite tečni deterdžent.

Korišćenje deterdženta u obliku gela i tablete

- Ako je gustina gel-deterdženta fluidna, a vaša mašina nema specijalnu šolju za teći deterdžent, gel stavite u odeljak za glavno pranje prilikom prvog uzimanja vode. Ako vaša mašina sadrži šolju za tečni deterdžent, sipajte ga u tu šolju pre nego što pokrenete program.
- Ako gustina gel-deterdženta nije fluidna ili je u deterdžent u obliku tablete sa kapsuliranom tečnošću, pre pranja ga stavite direktno u doboš.
- Deterdžent u obliku tablete stavite u odeljak za glavno pranje (odeljak br. "2") ili direktno u doboš pre pranja.

Upotreba štirka

Stavite tečnu sodu, sodu u puderu ili boju za tkaninu u odeljak za omekšivač.

Nemojte koristiti omekšivač i štirak zajedno u ciklusu pranja.

Posle korišćenja štirka, obrišite unutrašnjost mašine vlažnom i čistom krpom.

Korišćenje sredstva za uklanjanje kamenca

- Ako je potrebno, koristite sredstva za uklanjanje kamenca koja su proizvedena specijalno za mašine za pranje veša.

Korišćenje izbeljivača

- Dodajte izbeljivač na početku ciklusa pranja biranjem programa za pretpranje. Ne stavljajte deterdžent u odeljak za pretpranje. Drugi način bi bio da izaberete program sa dodatnim ispiranjem i dodate sredstvo za izbeljivanje dok mašina uzima vodu preko fioke za deterdžent tokom prve faze ispiranja.
- Ne mešajte sredstvo za izbeljivanje i deterdžent.
- Sredstvo za izbeljivanje koristite u maloj količini (oko 50 ml) i isperite dobro odeću jer može da iritira kožu. Nemojte da sipate izbeljivač na veš i nemojte da ga koristite sa obojenim vešom.
- Prilikom korišćenja sredstava za uklanjanje boje zasnovanih na kiseoniku, izaberite program koji pere veš na niskoj temperaturi.
- Sredstvo za skidanje boje zasnovano na kiseoniku se može koristiti sa deterdžentom; međutim, ako se ne nalaz u istom obliku, prvo stavite deterdžent u odeljak broj „2“ u posudu za deterdžent i sačekajte da mašina ispere deterdžent prilikom uzimanja vode. Dok mašina nastavlja da uzima vodu, dodajte sredstvo za uklanjanje boje u isti odeljak.

4.2.7 Saveti za efikasnije pranje

| | | Odeća | | | |
|-------------|--|--|--|--|--|
| | | Pastelne boje i beli veš | Boje | Crni/veš tamne boje | Osetljivo/Vuna/Svila |
| | | (Preporučeni opseg temperatura zavisi od zaprljanosti: 40-90 oC) | (Preporučeni opseg temperatura zavisi od zaprljanosti: hladno -40 oC) | (Preporučeni opseg temperatura zavisi od zaprljanosti: hladno -40 oC) | (Preporučeni opseg temperatura zavisi od zaprljanosti: hladno -30 oC) |
| Zaprljanost | Veoma prljav (teške mrlje, kao što su mrlje od trave, kafe, voda i krvi.) | Moguće je da bude potrebno da se mrlje tretiraju ili da se obavi pretpranje. Praškasti i tečni deterdženti koji su preporučeni za beli veš mogu se koristiti u dozama preporučenim za veoma prljav veš. Preporučuje se korišćenje praškastih deterdženata za čišćenje mrlja od blata, kao i mrlja koje reaguju na izbeljivače. | Praškasti i tečni deterdženti koji su preporučeni za veš u boji mogu se koristiti u dozama preporučenim za veoma prljav veš. Preporučuje se korišćenje praškastih deterdženata za čišćenje mrlja od blata, kao i mrlja koje reaguju na izbeljivače. Koristite deterdžente bez izbeljivača. | Praškasti i tečni deterdženti koji su preporučeni za veš u boji i tamne boje mogu se koristiti u dozama preporučenim za veoma prljav veš. | Za osetljivu odeću je bolje koristiti tečne deterdžente. Vunena i svilena odeća mora da se pere specijalnim deterdžentima za vunu. |
| | Normalno prljav (Na primer, za mrlje koje su izazvane znojenjem na okovratnicama i manžetnama) | Praškasti i tečni deterdženti koji su preporučeni za beli veš mogu se koristiti u dozama preporučenim za normalno prljav veš. | Praškasti i tečni deterdženti koji su preporučeni za veš u boji mogu se koristiti u dozama preporučenim za normalno prljav veš. Treba koristiti deterdžente koji ne sadrže izbeljivač. | Praškasti i tečni deterdženti koji su preporučeni za veš u boji i tamne boje mogu se koristiti u dozama preporučenim za normalno prljav veš. | Za osetljivu odeću je bolje koristiti tečne deterdžente. Vunena i svilena odeća mora da se pere specijalnim deterdžentima za vunu. |
| | Malo prljav (Nema vidljivih mrlja.) | Praškasti i tečni deterdženti koji su preporučeni za beli veš mogu se koristiti u dozama preporučenim za malo prljav veš. | Praškasti i tečni deterdženti koji su preporučeni za veš u boji mogu se koristiti u dozama preporučenim za malo prljav veš. Treba koristiti deterdžente koji ne sadrže izbeljivač. | Praškasti i tečni deterdženti koji su preporučeni za veš u boji i tamne boje mogu se koristiti u dozama preporučenim za malo prljav veš. | Za osetljivu odeću je bolje koristiti tečne deterdžente. Vunena i svilena odeća mora da se pere specijalnim deterdžentima za vunu. |

4.3 Rukovanje proizvodom

4.3.1 Kontrolna tabla

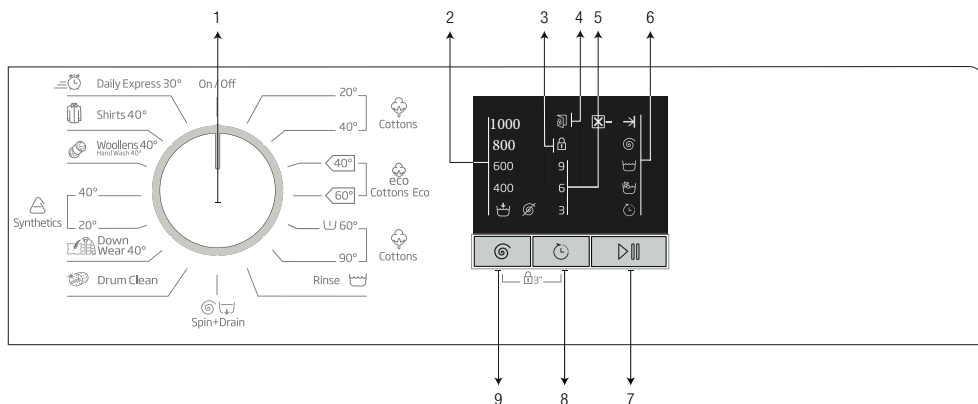

- 1 – Dugme za izbor programa (na vrhu je položaj za Uključivanje/isključivanje)
- 2 – LED lampice indikatora brzine centrifuge
- 3 – LED lampica za aktiviranje funkcije zaključavanja zbog dece
- 4 – LED lampica za aktiviranje funkcije zaključavanja vrata

- 5 – LED lampice indikatora za odlaganje početka
- 6 – LED lampice pratećeg indikatora programa
- 7 – Dugme Početak/pauza
- 8 – Dugme za podešavanje odlaganja početka
- 9 – Dugme za podešavanje brzine centrifuge

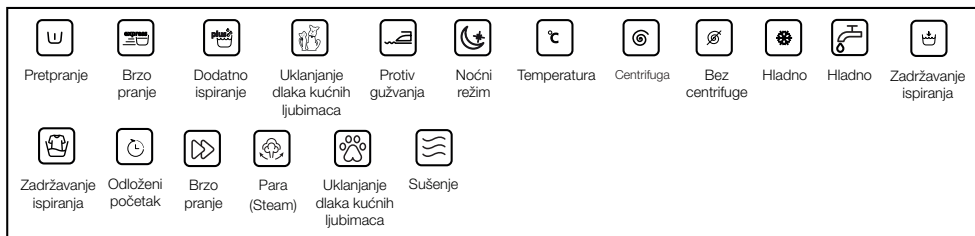

4.3.2 Priprema mašine

1. Uverite se da li su creva čvrsto spojena.
2. Uključite mašinu u struju.
3. Otvorite slavinu do kraja.
4. Stavite veš u mašinu.
5. Dodajte deterdžent i omekšivač za veš.

4.3.3 Biranje programa i saveti za efikasno pranje

1. Izaberite odgovarajući program prema tipu i količini veša i prema tome koliko je prijav u skladu sa tabelom „Tabela programa i potrošnje” i tabelom temperature ispod.
2. Izaberite traženi program putem dugmeta izbor programa.





4.3.4 Tabela programa i korišćenja

| SB | | | | | | | |
|---|--------------|------------------------|---------------------------|--------------------|--------------------------|-----------------|------|
| | Program (°C) | Maks. opterećenje (kg) | Trajanje programa (~ min) | Potrošnja vode (l) | Potrošnja energije (kWh) | Maks. brzina*** | |
| Cottons | 90 | 6 | 180 | 83 | 1,95 | 1000 | |
| | 40 | 6 | 180 | 81 | 1 | 1000 | |
| | 20 | 6 | 180 | 81 | 0,50 | 1000 | |
| Cottons 60° with Prewash (Prepranje za pamuk) | | 60 | 6 | 200 | 92 | 1,80 | 1000 |
| Cottons Eco | 60** | 6 | 255 | 46,4 | 0,918 | 1000 | |
| | 60** | 3 | 205 | 35,4 | 0,490 | 1000 | |
| | 40** | 3 | 205 | 35 | 0,485 | 1000 | |
| Synthetics | 40 | 2,5 | 120 | 66 | 0,75 | 1000 | |
| | 20 | 2,5 | 120 | 66 | 0,25 | 1000 | |
| Daily Express | | 30 | 6 | 28 | 60 | 0,15 | 1000 |
| Woollens / Hand Wash | | 40 | 1,5 | 65 | 45 | 0,45 | 1000 |
| Down Wear | | 40 | 1,5 | 105 | 85 | 0,80 | 1000 |
| Shirts | | 40 | 2,5 | 80 | 42 | 0,60 | 800 |
| Drum Clean | | 90 | - | 160 | 67 | 2,10 | 600 |

** : Program znaka za energiju (EN 60456 Ed.3)

***: Ako je maksimalna brzina centrifuge mašine manja od ove vrednosti, možete da birate samo do maksimalne brzine centrifuge.

- : Pogledajte opis programa za maksimalno opterećenje.

| | |
|--|---|
|  | ** „Pamuk Ekonomik 40 °C i Pamuk Ekonomik 60 °C su standardni programi.“ Ovi programi su poznati kao „40 °C, standardni program za pamuk“ i „60 °C, standardni program za pamuk“ i označeni su sa simbolima   na ploči. |
|  | Potrošnja vode i struje može da bude različita, što zavisi od promena u pritisku vode, tvrdoće vode i temperature, temperature okoline, vrste i količine veša, brzine centrifuge, kao i promena električnog napona. |
| | U zavisnosti od količine veša koji ste stavili u mašinu, može doći do vremenskog odstupanja u trajanju od 1–1,5 časova između trajanja pranja koje je prikazano u Tabeli programa i korišćenja i stvarnog trajanja pranja. Trajanje pranja će se automatski ažurirati ubrzo nakon početka pranja. |

Nominalne vrednosti za programe za pranje sintetike

| | Punjenje (kg) | Potrošnja vode (l) | Potrošnja struje (kWh) | Trajanje programa (min) | Preostala vlaga (%) ** | Preostala vlaga (%) ** |
|--------------|---------------|--------------------|------------------------|-------------------------|------------------------|------------------------|
| | | | | | ≤ 1000 rpm | > 1000 rpm |
| Sintetika 40 | 2,5 | 66 | 0,75 | 105/140 | 45 | 40 |
| Sintetika 20 | 2,5 | 66 | 0,25 | 105/140 | 45 | 40 |

** Vrednosti za preostalu vlagu mogu se razlikovati u zavisnosti od izabrane brzine centrifuge.

4.3.5 Glavni programi

Zavisno od vrste tkanine, koristite sledeće glavne programe.

- **Cottons (Pamuk)**

Koristite ovaj program za svoj pamučni veš (čaršafi, posteljina, peškiri, kućne haljine, donji veš itd.). Vaš veš će biti pran žustrim pokretima tokom dužeg ciklusa pranja.

- **Synthetics (Sintetika)**

Koristite za pranje svoje sintetičke odeće (košulje, bluze, odeća od sintetike / mešano s pamukom itd.). Veš će se prati uz laganije pokrete pranja i kraći ciklus pranja u poređenju sa programom „Pamuk“. Za zavese i til preporučuje se primena programa Sintetika na 20 °C ili 40 °C.

- **Woolens / Hand Wash (Vuna / Ručno pranje)**

Koristite za pranje svoje vunene/osetljive odeće. Veš se pere veoma laganim pokretima pranja da se odeća ne bi oštetila.

4.3.6 Dodatni programi

Ova mašina ima dodatne programe za posebne slučajeve.



Dodatni programi mogu da budu različiti, što zavisi od modela mašine.

- **Cottons Eco (Pamuk Eko)**

Koristite ovaj program za pranje veša koji se inače pere programom za pamuk duže vreme, on još uvek ima veoma dobre performanse uštede.



Program za pamuk Eko troši manje energije u odnosu na ostale programe za pamuk.

- **Cottons 60° with Prewash (Prepranje za pamuk)**

Koristite ovaj program za veoma prljav pamučni veš. Dodajte deterdžent u odeljak za prepranje.

- **Daily Express (Dnevno – ekspres)**

Koristite ovaj program za pranje pamučne odeće koja nije mnogo prljava za kraće vreme.

- **Shirts (Košulje)**

Ovaj program se koristi za pranje majica od pamuka, sintetike i uopšte tkanina koje sadrže sintetiku. Smanjuje gužvanje. Izvršava se algoritam prepranja.

- Nanesite hemijsko sredstvo za prepranje na svoj veš direktno ili ga dodajte uz deterdžent kada mašina počne da uzima vodu iz odeljka za glavno pranje. Tako će mašina oprati veš za kratko vreme, a predviđeni vek trajanja vaših košulja će se produžiti.

• Down Wear (Program Down Wear (Perje))

Koristite ovaj program za pranje kaputa, prsluka, jakni itd. koji sadrže perje i koji nose oznaku „pere se u mašini”. Zahvaljujući posebnim režimima rada centrifuge, zagarantovano je da voda u potpunosti dopre do međuprostora između perja.

• Drum Clean (Čišćenje doboša)

Koristite redovno (jednom na svakih 1-2 meseca) da biste očistili doboš i obezbedili potrebnu higijenu. Pokrenite program kada je mašina u potpunosti prazna. Da biste postigli bolje rezultate, stavite sredstvo za uklanjanje kamenca iz mašina za pranje u odeljak II za deterdžent. „2”. Kada se ovaj program završi, ostavite vrata za punjenje odškrinuta da bi se osušila unutrašnjost mašine.



Ovo nije program za pranje. Ovo je program za održavanje.

Nemojte da pokrećete program ako u mašini ima veša. Ukoliko pokušate da učinite to, mašina detektuje da u mašini ima veša i prekida program.

4.3.7 Posebni programi

Za posebne primene izaberite bilo koji od sledećih programa.

• Rinse (Ispiranje)

Koristite kada hoćete posebno ispiranje ili dodavanje štirka.

• Spin+Drain (Centrifuga + sušenje)

Možete da koristite ovu funkciju za uklanjanje vode sa veša ili za izbacivanje vode iz mašine.

Pre pokretanja ovog programa, izaberite traženu brzinu centrifuge i pritisnite dugme „Početak/pauza”. Prvo će mašina ispumpati vodu iz nje. Zatim će centrifugirati veš sa podešenom brzinom centrifuge i ispumpati vodu koja je izašla iz njega.

Ako hoćete samo da ispuštite vodu bez centrifugiranja veša, izaberite program „Ispumpavanje+centrifuga”, a zatim izaberite funkciju „Bez centrifuge” dugmetom za podešavanje brzine centrifuge. Pritisnite dugme „Početak/pauza”.



Za osetljiv veš koristite nižu brzinu centrifuge.

4.3.8 Izbor brzine

Kad god se izabere novi program, preporučena brzina centrifuge izabranog programa se prikazuje na indikatoru brzine centrifuge.

Da biste smanjili brzinu centrifuge, pritisnite dugme za podešavanje brzine centrifuge. Brzina centrifuge se postepeno smanjuje. Zatim se, zavisno od modela ovog proizvoda, na displeju prikazuju opcije „Zadržavanje ispiranja” i „Bez centrifuge”. Kada se izabere opcija „Bez centrifuge”, lampice indikatora nivoa ispiranja neće se uključiti.

Zadržavanje ispiranja

Ako nećete da izvadite svoju odeću odmah posle završetka programa, možete da koristite funkciju zadržavanje ispiranja i zadržali veš u poslednjoj vodi za ispiranje da biste sprečili gužvanje odeće kada u mašini nema vode. Pritisnite dugme „Početak/pauza” nakon ovog procesa ako želite da izbacite vodu bez centrifugiranja veša. Program će se nastaviti i dovršiti posle izbacivanja vode.

Ako želite da centrifugirate veš koji je stajao u vodi, podesite brzinu centrifuge i pritisnite dugme „Početak/pauza”.

Program će nastaviti rad. Voda se izbacuje, veš se centrifugira i program se završava.



Ako program nije stigao do faze centrifugiranja, brzinu možete da promenite bez prebacivanja mašine u režim pauze.

4.3.9 Odloženi početak

Pomoću funkcije „Odloženi početak” može se odložiti početak programa za 3, 6 ili 9 sati.



Ne upotrebljavajte tečni deterdžent kad koristite funkciju odloženog početka! Postoji opasnost da će na odeći ostati fleke.

1. Otvorite vrata za ubacivanje veša, stavite veš i sipajte deterdžent itd.
2. Izaberite program pranja i brzinu centrifuge.

3. Podesite željeno vreme pritiskom na dugme za odloženi početak. Kada se ovo dugme pritisne jednom, izabran je početak odložen za 3 sata. Ako se isto dugme ponovo pritisne, bira se odlaganje od 6 sati, a kada se pritisne po treći put, izabrano je odlaganje početka za 9 sati. Ako dugme za odloženi početak pritisnete još jednom, funkcija odloženog početka će biti otkazana.
4. Pritisnite dugme „Početak/pauza”. Lampica za prethodno odlaganje početka se gasi, a na svaka 3 sati se pali lampica za sledeće vreme odlaganja početka.
5. Na kraju odbrojavanja će sve lampice za odloženi početak da se ugase i uključice se izabrani program.



Možete da prebacite mašinu na režim pauze i da ubacite veš tokom vremena odlaganja početka.

Menjanje vremena odlaganja početka

Ako želite da promenite vreme tokom odbrojavanja, biće potrebno da otkazete program i da ponovo podesite vreme odlaganja.

Otkazivanje funkcije odloženog početka

Ako hoćete da opozovete odbrojavanje vremena odloženog početka i odmah uključite program:

1. Okrenite dugme za izbor programa na bilo koji program. Time će funkcija odlaganje početka biti otkazana. Lampica za „Kraj/otkazivanje” neprekidno trepće.
2. Zatim ponovo izaberite program koji želite da pokrenete.
3. Pritisnite dugme „Početak/pauza” da biste uključili program.

4.3.10 Pokretanje programa

1. Pritisnite dugme „Početak/pauza” da biste uključili program.
2. Upaliće se prateća lampica programa koja pokazuje početak programa.

4.3.11 Zaključavanje zbog dece

Koristite funkciju zaključavanja zbog dece da biste sprečili da se deca igraju mašinom. Na taj način možete sprečiti bilo kakve izmene programa koji je u toku.



Ako se dugme za izbor programa okreće dok je aktivno zaključavanje zbog dece, „LED lampica za aktivirano zaključavanje zbog dece” će zatreperiti 3 puta. Zaključavanje zbog dece ne dozvoljava nikakve promene programa ili izabrane brzine.

Čak i ako se putem dugmeta za izbor programa izabere neki drugi program dok je funkcija zaključavanja zbog dece aktivna, prethodno izabrani program će nastaviti da radi.

Kada je zaključavanje zbog dece aktivno i mašina radi, mašinu možete prebaciti u režim pauze bez deaktiviranja funkcije zaključavanja zbog dece tako što ćete okrenuti dugme za izbor programa u položaj Ukj./isk. Kad nakog toga ponovo okrenete dugme za izbor programa, prekinuti program će nastaviti rad.

Za aktiviranje zaključavanja zbog dece:

Pritisnite i držite dugmad za podešavanje brzine i odloženi početak 3 sekunde. Dok držite dugmad 3 sekunde, „LED lampica za aktiviranje zaključavanja zbog dece” će treperiti. Možete da otpustite dugmad kada LED lampice postanu neprekidno uključene.

Za deaktiviranje zaključavanja zbog dece:

Pritisnite i držite dugmad za podešavanje brzine i odloženi početak 3 sekunde tokom trajanja bilo kog programa. Dok držite dugmad 3 sekunde, „LED lampica za aktiviranje zaključavanja zbog dece” će treperiti. Možete da otpustite dugmad kada se LED lampica u potpunosti isključi.



Osim gore navedenog načina, da biste deaktivirali zaključavanja zbog dece, prebacite dugme za izbor programa u položaj Ukj./isk. dok je program u toku i izaberite drugi program.

Zaključavanje zbog dece se ne deaktivira zbog nestanka napajanja ili kada se mašina isključi iz struje.

4.3.12 Progres programa

Progres programa koji je u toku može se pratiti putem indikatora redosleda programa. Na početku svakog programskog koraka upaliće se odgovarajuća lampica indikatora a ugasiće se lampica završene faze. Možete da menjate podešenja brzine bez zaustavljanja programskog toka dok je program u toku. Da biste to uradili, promena koju želite da izvršite mora da bude u fazi iza programskog koraka koji je u toku. Ako promena nije kompatibilna, odgovarajuća lampica će zatreptati 3 puta.



Ako mašini ne prelazi na korak centrifuge, moguće je da je aktivirana funkcija zadržavanja ispiranja ili je aktiviran automatski sistem za detekciju neujednačenog opterećenja zbog neujednačene raspodele veša u mašini.

4.3.13 Brava na vratima za punjenje veša

Na vratima za punjenje veša postoji sistem zaključavanja koji sprečava otvaranje vrata za punjenje veša u slučaju kada je nivo vode neodgovarajući.

Lampica za vrata za punjenje veša će treptati kada mašina pređe u režim pauze. Mašina proverava nivo vode unutar nje. Ako je nivo odgovarajući, lampica za vrata za punjenje veša će se isključiti, a vrata za punjenje veša mogu da se otvore u roku od 1–2 minuta.

Ako je ovaj nivo neodgovarajući, lampica za vrata za punjenje veša ostaje uključena, a vrata za punjenje veša se ne mogu otvoriti. Ako morate da otvorite vrata za punjenje veša dok je lampica za vrata za punjenje veša uključena, morate da otkazete trenutni program. Pogledajte: „Otkazivanje programa”

4.3.14 Promena izbora kad je program već počeo

Prebacivanje mašine u režim pauze

Pritisnite dugme „Početak/pauza” da biste prebacili mašinu u režim pauze dok je neki program u toku.

Lampica za fazu u kojoj se mašina nalazi počinje da trepće u indikatoru redosleda programa kako bi pokazala da je mašina prebačena u režim pauze.

Uz to, ako se vrata za punjenje mogu otvoriti, isključuje se lampica za vrata za punjenje.

Promena podešavanja brzine

Možete da menjate podešavanja brzine prograga koji je u toku. Pogledajte „Izbor brzine”.



U slučaju da nije dozvoljena nikakva promena, odgovarajuća lampica će zatreperiti 3 puta.

Dodavanje ili vađenje veša

Možete da ubacujete/izbacujete veš dok je program u toku ako je nivo vode odgovarajući za otvaranje vrata. Da biste to uradili:

1. Pritisnite dugme „Početak/pauza” da biste prebacili mašinu u režim pauze. Osim toga, treptaće odgovarajuća lampica u indikatoru redosleda programa za programski korak tokom koga je mašina prebačena u režim pauze.
2. Sačekajte dok vrata za punjenje veša ne budu mogla da se otvore.
3. Otvorite vrata za punjenje veša i dodajte ili izvadite veš.
4. Zatvorite vrata za punjenje veša.
5. Po potrebi izvršite izmene u podešavanju brzine.
6. Pritisnite dugme „Početak/pauza” da biste pokrenuli mašinu.

4.3.15 Otkazivanje programa

Da biste otkazali program, okrenite dugme za izbor programa i izaberite drugi program. Prethodni program će biti otkazan. Lampica "kraj/otkazati" će neprekidno treptati da bi vas upozorila da je program otkazan.

Vaša mašina će prekinuti program kada okrenete dugme za izbor programa; međutim, ona neće izbaciti vodu iz nje. Ako izaberete i pokrenete novi program, novoizabrani program će početi u zavisnosti od koraka u kome je prethodni program otkazan. Na primer, može uzeti dodatnu vodu ili nastaviti da pere sa vodom unutar nje.



Neki programi se mogu pokrenuti izbacivanjem vode iz mašine. Zavisno od koraka u kome je program bio otkazan, možda ćete morati ponovo da dodate deterdžent i omekšivač za novi program koji ste izabrali.

4.3.16 Kraj programa

Kada se program završi, LED lampica za „Kraj” se uključuje na indikatoru za redosled programa.

1. Sačekajte dok se „LED lampica za aktiviranje funkcije zaključavanja vrata” u potpunosti ne isključi.
2. Da biste isključili mašinu, okrenite dugme za izbor programa na položaj za Uključ./isključ.
3. Izvadite veš i zatvorite vrata za punjenje. Vaša mašina je spremna za sledeći ciklus pranja.

4.3.17 Vaša mašina poseduje „Režim mirovanja”.

Nakon što uključite mašinu preko dugmeta za izbor programa (prebacivanjem dugmeta iz položaja za Uključ./isključ. u neki drugi položaj), ako se nijedan program ne pokrene ili se druga procedura ne obavi u vezi sa biranjem koraka ili se nijedna radnja ne preduzme približno 2 minuta nakon što se izabrani program završi, mašina će se automatski prebaciti na režim uštede energije. Sjaj lampica indikatora će se smanjiti. Takođe, ako vaš proizvod ima ekran koji pokazuje vreme programa, taj ekran će se potpuno isključiti. Ako okrenete dugme za izbor programa ili pritisnete neko drugo dugme, lampice i ekran će se vratiti u prethodno stanje. Ono što izaberete prilikom izlaska iz energetske efikasnosti može se promeniti. Proverite da li su izbori odgovarajući pre pokretanja programa. Ako je to potrebno, ponovo izvršite podešavanja. Ovo nije greška.

4.4 Održavanje i čišćenje

Radni vek proizvoda se produžava i česti problemi će se smanjiti ako se čisti redovno.

4.4.1 Čišćenje fiokje za deterdžent

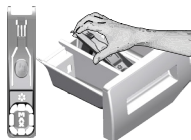

Redovno (svakih 4-5 ciklusa pranja) čistite fiokju za deterdžent kao što je pokazano u nastavku da biste sprečili taloženje praška tokom vremena. Podignite zadnji deo sifona da biste ga izvadili, kao što je pokazano na slici. Ako u odeljku za omekšivač počne da se nakuplja više mešavine vode i omekšivača nego obično, sifon mora da se očisti.

- 1 Pritisnite tačku na sifonu u odeljku za omekšivač i vucite prema sebi dok ne izvadite odeljak iz mašine.
- 2 Operite fiokju za deterdžent i sifon u lavabou sa puno mlake vode. Da biste sprečili da ostaci dođu u kontakt sa vašim kožom, očistite ih odgovarajućom četkom noseći rukavice.
- 3 Posle čišćenja vratite fiokju na mesto i uverite se da je dobro postavljena.

4.4.2 Čišćenje vrata za punjenje i doboša

Za proizvode sa programom čišćenja bubnja, pogledajte odeljak Rukovanje proizvodom - Programi.



Proces čišćenja doboša treba ponavljati na svaka 2 meseca.

Koristite sredstvo za uklanjanje kamenca koje je podesno za mašine za pranje veša.



Posle svakog pranja proverite da nikakve materije nisu zaostale u dobošu. Ako su otvori na odeljku (kao na slici) blokirani, otvorite ih pomoću čačkalice. Strani metal će dovesti do stvaranja mrlja od rđe u dobošu. Očistite mrlje na površini bubnja koristeći sredstva za čišćenje za nerđajući čelik. Nikada nemojte da koristite čeličnu bunu ili žičanu vunu. To će oštetiti obojenom, hromirane i plastične površine.

4.4.3 Čišćenje kućišta i komandne table

Kućište mašine obrišite sapunicom ili nekorozivnim blagim gel deterdžentom, ako je potrebno, i osušite mekom krpom.

Za čišćenje komandne table koristite samo meku i vlažnu krpom.

4.4.4 Čišćenje filtera za dovod vode

Na kraju svakog ventila za dovod vode na poledini mašine i na kraju svakog creva za dovod vode, na mestu gde se spaja na slavinu, nalazi se filter. Ti filteri sprečavaju ulazak stranih tela i prljavštine iz vode u mašinu za pranje veša. Filteri treba da se čiste kad se uprljaju.

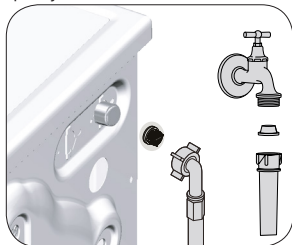

- 1 Zatvorite slavine.
- 2 Izvadite navrtke creva za dovod vode da biste pristupili filterima na ventilima za dovod vode. Očistite ih prikladnom četkom. Ako su filteri previše prljavi, izvadite ih pomoću klješta i očistite ih.
- 3 Izvadite filtere na ravnim krajevima creva za dovod vode zajedno sa zaptivačima i dobro ih očistite pod tekućom vodom.
- 4 Ponovo postavite zaptivke i filtere pažljivo i zategnite ih ručno.

4.4.5 Ispuštanje preostale vode i čišćenje filtera pumpe

Sistem filtera u Vašoj mašini sprečava da predmeti kao što su dugmad, novčići i niti tkanina začepe propeler pumpe za vreme izbacivanja vode od pranja. Zbog toga će voda biti izbačena bez ikakvih problema, a servisni vek trajanja pumpe će biti duži.

Ako mašina ne uspe da izbaci vodu, filter pumpe može da bude začepljen. Filter se mora čistiti kad god je začepljen ili na svaka 3 meseca. Da bi se očistio filter pumpe prvo se mora izbaciti voda.

Osim toga, pre transportovanja mašine (npr. preseľenje u drugu kuću) i u slučaju zamrzavanja vode, vodu ćete možda morati u potpunosti da izbacite.



PAŽNJA: Strane materije koje su zaostale u filteru pumpe mogu da oštete vašu mašinu ili da izazovu problem sa bukom.

PAŽNJA: Ako se proizvod ne koristi, isključite slavinu, skinite glavnu cev i istočite vodu iz mašine zbog smrzavanja.

PAŽNJA: Nakon svake upotrebe, isključite slavinu za glavni dotok vode.

Da biste očistili prljavi filter i ispuštali vodu:

1 Isključite mašinu da biste prekinuli dovod električne energije.



PAŽNJA: Temperatura vode u mašini može da se poveća do 90 °C. Da biste izbegli rizik od opekotina, očistite filter nakon što se voda u unutrašnjosti ohladi.

2. Otvorite poklopac za filter.

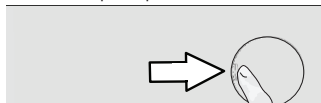

3 Pratite proceduru ispod da biste ispuštali vodu.

Ako proizvod nema crevo za hitno ispuštanje vode, da biste ispuštali vodu:

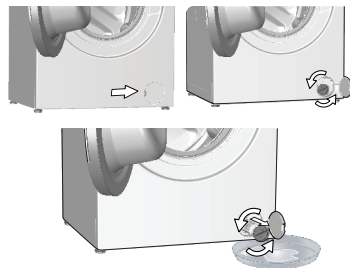

- Da biste sakupili vodu koja ističe iz filtera, postavite veći sud ispred filtera.
- Okrenite i olabavite filter pumpe dok voda ne počne da teče (u smeru suprotnom kretanju kazaljke na satu). Usmerite vodu koja teče u kofu koju ste stavili ispred filtera. Imajte uvek pri ruci krpu da biste pokupili prolivenu vodu.
- Kada se voda iz mašine potpuno izbaci, okrećite filter da biste ga skinuli.

4 Očistite sav talog u filteru, kao i vlakna oko propelera pumpe, ako ih ima.

5. Vratite filter.

6. Ako se poklopac filtera sastoji iz dva dela, zatvorite poklopac filtera pritiskom na polugicu. Ako je iz jednog komada, polugice na nižem delu prvo postavite na njihova mesta, a zatim pritisnite gornji deo radi zatvaranja.

| Problem | Razlog | Rešenje |
|---|--|--|
| Program se ne pokreće nakon zatvaranja vrata. | Dugme za Pokretanje / Puziranje / Otkazivanje nije pritisnuto. Zatvaranje vrata za punjenje veša može biti otežano u slučaju prekomernog punjenja. | <ul style="list-style-type: none"> Pritisnite dugme za Pokretanje / Puziranje / Otkazivanje. Smanjite količinu veša i postarajte se da vrata za punjenje budu pravilno zatvorena. |
| Program ne može da se uključi ili izabere. | Mašina za pranje veša se možda prebacila u režim samozaštite zbog problema sa snabdevanjem (kao što su napon, pritisak vode itd.). | <ul style="list-style-type: none"> Da biste otkazali program, okrenite dugme za izbor programa i izaberite drugi program. Prethodni program će biti otkazan. (Pogledajte "Otkazivanje programa") |
| Voda u mašini. | U proizvodnju je možda ostalo malo vode iz procesa kontrole kvaliteta u proizvodnji. | <ul style="list-style-type: none"> To nije kvar; voda nije štetna za mašinu. |
| Mašina ulazi u režim pripravnosti nakon što se pokrene program ili ne prima vodu. | Slavina je isključena. Crevo za ulaz vode je savijeno. | <ul style="list-style-type: none"> Otvorite slavinu. Ispravite crevo. |
| | Filter za ulaz vode je zapušten. Vrata za ubacivanje veša su možda otvorena. Priključak za vodu je možda neispravan ili je dotok vode prekinut (kada je dotok vode prekinut, LED lampice za pranje ili ispiranje počnu da trepere). | <ul style="list-style-type: none"> Očistite filter. Zatvorite vrata. Proverite priključak za vodu. Ako je dotok vode prekinut, pritisnite taster Početak/pauza nakon što se voda ponovo doprema da bi se nastavio postupak iz režima pripravnosti. |
| Mašina ne izbacuje vodu. | Crevo za izbacivanje vode je možda zapušeno ili uvrnuto. Filter pumpe je zapušten. | <ul style="list-style-type: none"> Očistite ili ispravite crevo. Očistite filter pumpe . |
| | Mašina vibrira ili pravi buku. | <ul style="list-style-type: none"> Nivelisite mašinu podešavanjem nožica. Očistite filter pumpe . Skinite bezbednosne transportne vijke. Dodajte više veša u mašinu. Izvadite malo veša iz mašine ili rukom popravite ravnotežu veša. Pobrinite se da se mašina ne naslanja ni na kakav predmet. |
| Postoji curenje vode na dnu mašine za pranje veša. | Crevo za izbacivanje vode je možda zapušeno ili uvrnuto. Filter pumpe je zapušten. | <ul style="list-style-type: none"> Očistite ili ispravite crevo. Očistite filter pumpe . |
| | Mašina je stala ubrzo nakon početka programa. | <ul style="list-style-type: none"> Ona će nastaviti s radom kada se napon bude vratio na normalan nivo. |
| Mašina direktno prazni vodu koju prihvata. | Crevo za pražnjenje možda nije na adekvatnoj visini. | <ul style="list-style-type: none"> Priključite crevo za pražnjenje kao što je opisano u priručniku za rukovanje. |
| Voda se ne može videti u mašini tokom pranja. | Nivo vode nije vidljiv spolja. | <ul style="list-style-type: none"> Ovo nije greška. |
| Vrata za ubacivanje veša se ne mogu otvoriti. | Zaključavanje vrata je aktivirano zbog nivoa vode u mašini. Mašina greje vodu ili je u ciklusu centrifuge. Aktivirano je zaključavanje zbog dece. Zaključana vrata će se otključati nekoliko minuta nakon završetka programa. Vrata za punjenje se mogu zaglaviti zbog pritiska kome su izložena. | <ul style="list-style-type: none"> Ispustite vodu pokretanjem programa Pumpa ili Centrifuga. Sačekajte dok se program ne završi. Sačekajte nekoliko minuta za deaktivaciju zaključanih vrata. Uхватite ručku i povucite i gurnite vrata za punjenje da biste ih oslobodili i otvorili. |
| | Pranje traje duže nego što je naznačeno u uputstvu.(*) | Pritisak vode je nizak. |
| Napon može biti nizak. | | <ul style="list-style-type: none"> Vreme pranja se produžava da bi se izbegli loši rezultati pranja kada je napon nizak. |
| Temperatura dolazne vode je možda niska. | | <ul style="list-style-type: none"> Vreme potrebno za grejanje vode se produžava u hladnim godišnjim dobima. Takođe, vreme pranja se može produžiti kako bise izbegli loši rezultati pranja. |
| Broj ispiranja i/ili količina vode za ispiranje je možda povećana. Moгуće je da je došlo do stvaranja prevelike pene i da je sistem za automatsku apsorpciju pene aktiviran zbog prekomerne količine deterđenta. | | <ul style="list-style-type: none"> Mašina povećava količinu vode za ispiranje kada je potrebno dobro ispiranje i dodaje dodatni korak ispiranja ako je potrebno. Koristite preporučenu količinu deterđenta. |

| Problem | Razlog | Rešenje |
|---|--|--|
| Trajanje programa se ne odbrojava. (kod modela sa displejem) (*) | Tajmer je možda zaustavljen zbog uzimanja vode. | <ul style="list-style-type: none"> Tajmer neće odbrojavati dok mašina ne uzme dovoljnu količinu vode. Mašina će sačekati dok u njoj ne bude dovoljna količina vode da bi se izbegli slabi rezultati pranja zbog nedostatka vode. Indikator tajmera će nakon toga nastaviti sa odbrojavanjem. |
| | Tajmer se može zaustaviti tokom koraka zagrevanja. | <ul style="list-style-type: none"> Indikator tajmera neće odbrojavati dok mašina ne dostigne izabranu temperaturu. |
| | Tajmer se može zaustaviti tokom koraka centrifugiranja. | <ul style="list-style-type: none"> Moguće je da je došlo do aktiviranja sistema za automatsku detekciju neuravnoteženog opterećenje zbog neujednačene raspodele veša u bubnju. |
| Trajanje programa se ne odbrojava. (*) | Možda ima nebalansiranog veša u mašini. | <ul style="list-style-type: none"> Moguće je da je došlo do aktiviranja sistema za automatsku detekciju neuravnoteženog opterećenje zbog neujednačene raspodele veša u bubnju. |
| Mašina ne prabacuje na korak centrifugiranja. (*) | Možda ima nebalansiranog veša u mašini. | <ul style="list-style-type: none"> Moguće je da je došlo do aktiviranja sistema za automatsku detekciju neuravnoteženog opterećenje zbog neujednačene raspodele veša u bubnju. |
| | Mašina neće centrifugirati ako se voda ne isprazni u potpunosti. | <ul style="list-style-type: none"> Proverite filter i crevo za pražnjenje. |
| | Moguće je da je došlo do stvaranja prevelike pene i da je sistem za automatsku apsorpciju pene aktiviran zbog prekomerne količine deterdženta. | <ul style="list-style-type: none"> Koristite preporučenu količinu deterdženta. |
| Učinak pranja je loš: Veš postaje siv. (**) | Nedovoljna količina deterdženta se koristi tokom dužeg vremenskog perioda. | <ul style="list-style-type: none"> Koristite preporučenu količinu deterdženta koja odgovara tvrdoći vode i vešu. |
| | Pranje je obavljeno na niskim temperaturama tokom dužeg vremena. | <ul style="list-style-type: none"> Izaberite odgovarajuću temperaturu za pranje veša. |
| | Nedovoljna količina deterdženta se koristi sa tvrdom vodom. | <ul style="list-style-type: none"> Korišćenje nedovoljne količine deterdženta sa tvrdom vodom dovodi do lepljenja nečistoća na odeću i vremenom odeća postaje siva. Teško je eliminisati sivu boju kada se to dogodi. Koristite preporučenu količinu deterdženta koja odgovara tvrdoći vode i vešu. |
| | Koristi se previše deterdženta. | <ul style="list-style-type: none"> Koristite preporučenu količinu deterdženta koja odgovara tvrdoći vode i vešu. |
| Učinak pranja je loš: Mrlje istrajavaju ili se veš ne beli. (**) | Koristi se nedovoljna količina deterdženta. | <ul style="list-style-type: none"> Koristite preporučenu količinu deterdženta koja odgovara tvrdoći vode i vešu. |
| | Ubačena je prekomerna količina veša. | <ul style="list-style-type: none"> Nemojte prekomerno da ubacujete veš. Ubacite količine veša preporučene u „Tabeli programa i potrošnje“. |
| | Izabrani su pogrešan program i temperatura. | <ul style="list-style-type: none"> Izaberite odgovarajuću temperaturu i program za pranje veša. |
| | Pogrešan tip deterdženta se koristi. | <ul style="list-style-type: none"> Koristite originalni deterdžent koji odgovara mašini. |
| | Koristi se previše deterdženta. | <ul style="list-style-type: none"> Stavite deterdžent u odgovarajući odeljak. Nemojte da mešate sredstvo za beljenje i deterdžent. |
| Učinak pranja je loš: Mrlje od ulja ostaju na vešu. (**) | Regularno pranje u bubnju se ne primenjuje. | <ul style="list-style-type: none"> Očistite bubanj redovno. Pogledajte odeljak 4.4.2. |
| Učinak pranja je loš: Odeća ne miriše prijatno. (**) | Mirisi i slojevi bakterija se formiraju na bubnju kao rezultat neprekidnog pranja na nižim temperaturama i/ili kraćim programima. | <ul style="list-style-type: none"> Ostavite fioku deterdženta kao i vrata za ubacivanje veša otvorene nakon svakog pranja. Tako neće doći do stvaranja vlažnog okruženja koje odgovara baterijama. |
| Boja odeće bleđi. (**) | Ubačena je prekomerna količina veša. | <ul style="list-style-type: none"> Nemojte prekomerno da ubacujete veš. |
| | Deterdžent koji se koristi je vlažan. | <ul style="list-style-type: none"> Deterdžente držite zatvorenim u okruženju koje nije vlažno i nemojte da ih izlažete prekomernim temperaturama. |
| | Izabrana je viša temperatura. | <ul style="list-style-type: none"> Izaberite odgovarajući program i temperaturu u skladu sa tipom i stepenom zaprljanosti veša. |

| Problem | Razlog | Rešenje |
|--|---|--|
| Ne ispira se dobro. | Količina, brend i uslovi skladištenja deterdženta koji se koristi je neodgovarajući. | <ul style="list-style-type: none"> • Koristite deterdžent koji odgovara mašini za pranje i vašem vešu. Deterdžente držite zatvorenim u okruženju koje nije vlažno i nemojte da ih izlažete prekomernim temperaturama. |
| | Deterdžent je stavljen u pogrešan odeljak. | <ul style="list-style-type: none"> • Ako se deterdžent stavi u odeljak za pretpranje iako ciklus pretpranja nije izabran, mašina može da uzme ovaj deterdžent tokom koraka ispiranja ili uzimanja omekšivača. Stavite deterdžent u odgovarajući odeljak. |
| | Filter pumpe je zapušten. | <ul style="list-style-type: none"> • Očistite filter. |
| | Crevo za odvod je savijeno. | <ul style="list-style-type: none"> • Proverite crevo za odvod. |
| Veš postaje krut nakon pranja. (**) | Koristi se nedovoljna količina deterdženta. | <ul style="list-style-type: none"> • Korišćenjem nedovoljne količine deterdženta u poređenju sa tvrdoćom vode može dovesti do stvrdnjavanja vode vremenom. Koristite odgovarajuću količinu deterdženta na osnovu tvrdoće vode. |
| | Deterdžent je stavljen u pogrešan odeljak. | <ul style="list-style-type: none"> • Ako se deterdžent stavi u odeljak za pretpranje iako ciklus pretpranja nije izabran, mašina može da uzme ovaj deterdžent tokom koraka ispiranja ili uzimanja omekšivača. Stavite deterdžent u odgovarajući odeljak. |
| | Deterdžent je možda pomešan sa omekšivačem. | <ul style="list-style-type: none"> • Nemojte da mešate omekšivač sa deterdžentom. Operite i očistite posudu vrućom vodom. |
| Veš ne miriše kao omekšivač. (**) | Deterdžent je stavljen u pogrešan odeljak. | <ul style="list-style-type: none"> • Ako se deterdžent stavi u odeljak za pretpranje iako ciklus pretpranja nije izabran, mašina može da uzme ovaj deterdžent tokom koraka ispiranja ili uzimanja omekšivača. Operite i očistite posudu vrućom vodom. Stavite deterdžent u odgovarajući odeljak. |
| | Deterdžent je možda pomešan sa omekšivačem. | <ul style="list-style-type: none"> • Nemojte da mešate omekšivač sa deterdžentom. Operite i očistite posudu vrućom vodom. |
| Deterdžent zaostaje u fioci za deterdžent. (**) | Deterdžent je stavljen u vlažnu fioku. | <ul style="list-style-type: none"> • Osušite fioku za deterdžent pre stavljanja deterdženta. |
| | Deterdžent je navlažen. | <ul style="list-style-type: none"> • Deterdžente držite zatvorenim u okruženju koje nije vlažno i nemojte da ih izlažete prekomernim temperaturama. |
| | Pritisak vode je nizak. | <ul style="list-style-type: none"> • Proverite pritisak vode. |
| | Deterdžent u odeljku za glavno pranje je navlažen tokom uzimanja vode za pretpranje. Otvori odeljka za deterdžent su blokirani. | <ul style="list-style-type: none"> • Proverite otvore i očistite ako su zapušeni. |
| | Postoji problem sa ventilima u fioci za deterdžent. | <ul style="list-style-type: none"> • Pozovite ovlašćenog serviseru. |
| | Deterdžent je možda pomešan sa omekšivačem. | <ul style="list-style-type: none"> • Nemojte da mešate omekšivač sa deterdžentom. Operite i očistite posudu vrućom vodom. |
| | Regularno pranje u bubnju se ne primenjuje. | <ul style="list-style-type: none"> • Očistite bubanj redovno. Pogledajte odeljak 4.4.2. |
| Previše pene se stvara u mašini. (**) | Neodgovarajući deterdžent za pranje mašine se koristi. | <ul style="list-style-type: none"> • Koristite deterdžent koji odgovara mašini za pranje. |
| | Prekomerna količina deterdženta se koristi. | <ul style="list-style-type: none"> • Koristite samo dovoljnu količinu deterdženta. |
| | Deterdžent se skladišti u neodgovarajućim uslovima. | <ul style="list-style-type: none"> • Čuvajte deterdžent na zatvorenoj i suvoj lokaciji. Nemojte da ga čuvate na prekomerno vrućim mestima. |
| | Neki mešoviti veš kao što je veš od tila može da pravi prekomernu penu zbog svoje teksture. | <ul style="list-style-type: none"> • Koristite manje količine deterdženta za ovaj tip odeće. |
| | Deterdžent je stavljen u pogrešan odeljak. | <ul style="list-style-type: none"> • Stavite deterdžent u odgovarajući odeljak. |
| Pena izlazi iz fioke za deterdžent. | Omekšivač se preuzima rano. | <ul style="list-style-type: none"> • Može postojati problem sa ventilima ili u odeljku za deterdžent. Pozovite ovlašćenog serviseru. |
| | Koristi se previše deterdženta. | <ul style="list-style-type: none"> • Izmešajte 1 kašiku omekšivača i ½ litra vode i sipajte u odeljak za glavno pranje fioke za deterdžent. • U mašinu stavite deterdžent koji je pogodan za programe i maksimalna opterećenja navedena u "Tabeli programa i korišćenja". Ako koristite dodatne hemikalije (sredstva za uklanjanje fleka, izbeljivače itd.) smanjite količinu deterdženta. |

| Problem | Razlog | Rešenje |
|--|---|---|
| Veš ostaje mokar na kraju programa. (*) | Moguće je da je došlo do stvaranja prevelike pene i da je sistem za automatsku apsorpciju pene aktiviran zbog prekomerne količine deterdženta. | <ul style="list-style-type: none"> • Koristite preporučenu količinu deterdženta. |
| (*) Mašina se ne prebacuje na korak centrifuge ako veš nije raspodeljen ravnomerno u bubnju da bi se sprečilo oštećenje mašine i njene okoline. Veš treba da se ponovo preraspodeli i da se ponovo uključi centrifuga. | | |
| (**) Regularno pranje u bubnju se ne primenjuje. Očistite bubanj redovno. Pogledajte 4.4.2 | | |
|  | PAŽNJA: Ako ne možete da eliminišete problem iako ste pratili uputstva iz ovog odeljka, obratite se svom dobavljaču ili ovlašćenom serviseru. Nikad nemojte sami da pokušavate da popravite neispravan proizvod. | |



Washing Machine

User's Manual



WUE 6511 XWW

EN



1 General safety instructions

This section includes security instructions which may help prevent the injuries and material damage risks. All kinds of warranties shall be invalid if these instructions are not observed.

1.1 Life and property safety

- ▶ Never place the product on a carpet-covered floor. Electrical parts will get overheated since air cannot circulate from under the device. This will cause problems with your product.
- ▶ Unplug the product if it is not in use.
- ▶ Always have the installation and repairing procedures carried out by the Authorised Service Agent. The manufacturer shall not be held liable for damages that may arise from procedures carried out by unauthorised persons.
- ▶ The water supply and draining hoses must be securely fastened and remain undamaged. Otherwise, water leak may occur.
- ▶ While there is still water inside the product, never open the loading door or remove the filter. Otherwise, risk of flooding and injury from hot water will occur.
- ▶ Do not force open the locked loading door. Door can be opened a few minutes after the washing cycle ends. In case of forcing the loading door to open, the door and the lock mechanism may get damaged.
- ▶ Use detergents, softeners and supplements suitable for automatic washing machines only.
- ▶ Follow the instructions on the label of textiles and the detergent package.

1.2 Children's safety

- ▶ This product can be used by the children who are at the age of 8 and over and the people whose physical, sensory or mental skills are not fully developed or who do not have necessary required experience and knowledge as long as they are supervised or trained about the safe use of the product and its risks. Children should not play with the device. Cleaning and maintenance works should not be performed by children unless they are supervised by someone. Children of less than 3 years should be kept away unless continuously supervised.
- ▶ Packaging materials may be dangerous for the children. Keep packaging materials in a safe place away from reach of the children.

- ▶ Electrical products are dangerous for the children. Keep the children away from the product when it is in use. Do not allow them to play with the product. Use child lock to prevent children from intervening with the product.
- ▶ Do not forget to close the loading door when leaving the room where the product is located.
- ▶ Store all detergents and additives in a safe place away from the reach of the children by closing the cover of the detergent container or sealing the detergent package.

1.3 Electrical safety

- ▶ If the product has a failure, it should not be operated unless it is repaired by the Authorised Service Agent. Risk of electric shock!
- ▶ This product is designed to resume operating in the event of powering on after a power interruption. If you wish to cancel the programme, see "Cancelling the programme" section.
- ▶ Plug the product into a grounded outlet protected by a 16 A fuse. Do not neglect to have the grounding installation made by a qualified electrician. Our company shall not be liable for any damages that will arise when the product is used without grounding in accordance with the local regulations.
- ▶ Do not wash the product by spraying or pouring water onto it! Risk of electric shock!
- ▶ Never touch the power cable plug with wet hands! Do not grab the power cord to unplug the machine, always unplug it by holding the socket with one hand, and pulling the plug with the other hand.
- ▶ Product should be unplugged during installation, maintenance, cleaning and repair procedures.
- ▶ If the power cable is damaged, it must be replaced by the manufacturer, after sales service or a similarly qualified person (preferably an electrician) or someone designated by the importer in order to avoid possible risks.

1.4 Hot surface safety

| | |
|---|--|
|  | <p>While washing the laundry at high temperatures, the loading door glass will get hot. Considering this fact, during washing operation keep the children away from the loading door of the product to prevent them touching it.</p> |
|---|--|

2 Important instructions for environment

2.1 Compliance with WEEE Directive

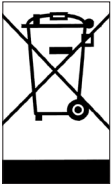

This product complies with EU WEEE Directive (2012/19/EU). This product bears a classification symbol for waste electrical and electronic equipment (WEEE).

This product has been manufactured with high quality parts and materials which can be reused and are suitable for recycling. Do not dispose of the waste product with normal domestic and other wastes at the end of its service life. Take it to the collection center for the recycling of electrical and electronic equipment. Please consult your local authorities to learn about these collection centers.

Compliance with RoHS Directive:

The product you have purchased complies with EU RoHS Directive (2011/65/EU). It does not contain harmful and prohibited materials specified in the Directive.

2.2 Package information

Packaging materials of the product are manufactured from recyclable materials in accordance with our National Environment Regulations. Do not dispose of the packaging materials together with the domestic or other wastes. Take them to the packaging material collection points designated by the local authorities.

3 Intended use

- This product has been designed for domestic use. It is not for commercial purposes or it should not be used out of its intended use.
- The product must only be used for washing and rinsing of laundry that are marked accordingly.
- The manufacturer waives any responsibility arisen from incorrect usage or transportation.
- The service life of your product is 10 years. During this period, original spare parts will be available to operate the appliance properly.

4 Technical specifications

Complying Commission Delegated Regulation (EU) No 1061/2010

| | |
|---|--------------------------|
| Supplier name or trademark | Beko |
| Model name | WUE 6511 XWW |
| Rated capacity (kg) | 6 |
| Energy efficiency class / Scale from A+++ (Highest Efficiency) to D (Lowest Efficiency) | A+++ |
| Annual Energy Consumption (kWh) ⁽¹⁾ | 152 |
| Energy consumption of the standard 60°C cotton programme at full load (kWh) | 0,918 |
| Energy consumption of the standard 60°C cotton programme at partial load (kWh) | 0,490 |
| Energy consumption of the standard 40°C cotton programme at partial load (kWh) | 0,485 |
| Power consumption in 'off-mode' (W) | 0,250 |
| Power consumption in 'left-on mode' (W) | 0,750 |
| Annual Water Consumption (l) ⁽²⁾ | 8799 |
| Spin-drying efficiency class / Scale from A (Highest Efficiency) to G (Lowest Efficiency) | C |
| Maximum spin speed (rpm) | 1000 |
| Remaining moisture Content (%) | 62 |
| Standard cotton programme ⁽³⁾ | Cotton Eco 60°C and 40°C |
| Programme time of the standard 60°C cotton programme at full load (min) | 255 |
| Programme time of the standard 60°C cotton programme at partial load (min) | 205 |
| Programme time of the standard 40°C cotton programme at partial load (min) | 205 |
| Duration of the left-on mode (min) | N/A |
| Airborne acoustical noise emissions washing/spinning (dB) | 6%7' |
| Built-in | No |
| Height (cm) | 84 |
| Width (cm) | 60 |
| Depth (cm) | 44 |
| Net weight (±4 kg.) | 55 |
| Single Water inlet / Double Water inlet | • / - |
| • Available | |
| Electrical input (V/Hz) | 230 V / 50Hz |
| Total current (A) | 10 |
| Total power (W) | 1550 |
| Main model code | 9213 |

⁽¹⁾ Energy Consumption based on 220 standard washing cycles for cotton programmes at 60°C and 40°C at full and partial load, and the consumption of the low-power modes. Actual energy consumption will depend on how the appliance is used.

⁽²⁾ Water consumption based on 220 standard washing cycles for cotton programmes at 60°C and 40°C at full and partial load. Actual water consumption will depend on how the appliance is used.

⁽³⁾ "Standard 60°C cotton programme" and the "standard 40°C cotton programme" are the standard washing programmes to which the information in the label and the fiche relates and these programmes are suitable to clean normally soiled cotton laundry and that they are the most efficient programmes in terms of combined energy and water consumption.

Technical specifications may be changed without prior notice to improve the quality of the product.

4.1 Installation

- Apply to the nearest authorised service agent for the installation of your product.
- Preparation of the location and electrical, tap water and waste water installations at the place of installation is under customer's responsibility.
- Make sure that the water inlet and discharge hoses as well as the power cable are not folded, pinched or crushed while pushing the product into its place after installation or cleaning procedures.
- Make sure that the installation and electrical connections of the product are performed by authorised service. Manufacturer shall not be held liable for damages that may arise from procedures carried out by unauthorised persons.
- Prior to installation, visually check if the product has any defects on it. If so, do not have it installed. Damaged products cause risks for your safety.

4.1.1 Appropriate installation location

- Place the product on a hard and level floor. Do not put it onto a carpet with high pile or other similar surfaces.
- When the washing machine and dryer are placed on top of each other, their total weight -when loaded- amounts to 180 kilograms. Place the product on a solid and flat floor that has sufficient load carrying capacity!
- Do not place the product on the power cable.
- Do not install the product in the environments where the temperature falls below 0 °C.
- Leaving a gap at the sides of the machine is suggested to reduce vibration and noise
- On a graduated floor, do not place the product next to the edge or on a platform.
- Do not place heat sources such as Hobs, Irons, Ovens, etc. on the washing machine and do not use them on the product.

4.1.2 Removing packaging reinforcement(if it has)



Tilt the machine backwards to remove the packaging reinforcement. Remove the packaging reinforcement by pulling the ribbon. Do not make this operation alone by yourself.

4.1.3 Removing the transportation locks

- 1 Loosen all bolts with an appropriate wrench until they turn freely.
- 2 Remove the transport safety bolts by turning them slightly.
- 3 Insert the plastic covers in the bag containing the user manual to the openings on the rear panel.

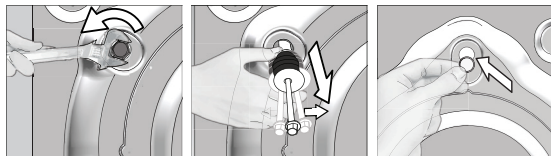

CAUTION: Remove the transportation safety bolts before operating the washing machine! Otherwise, the product will be damaged.



Keep the transportation safety bolts in a safe place to reuse when the washing machine needs to be moved again in the future.

Install the transport safety bolts in reverse order of the disassembly procedure.

Never move the product without the transportation safety bolts properly fixed in place!

4.1.4 Connecting water supply



The water supply pressure required to run the product is between 1 to 10 bars (0.1 - 1 MPa). It is necessary to have 10 - 80 liters of water flowing from the fully open tap in one minute to have your machine run smoothly. Attach a pressure reducing valve if water pressure is higher.



CAUTION: Models with a single water inlet should not be connected to the hot water tap. In such a case the laundry will get damaged or the product will switch to protection mode and will not operate.

CAUTION: Do not use old or used water inlet hoses on the new product. It may cause stains on your laundry.

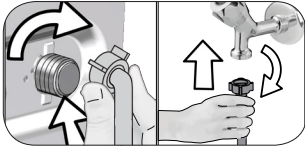

- 1 Tighten the nuts of the hose by hand. Never use a tool when tightening the nuts.
- 2 When hose connection is completed, check whether there is leak problems at the connection points by opening the taps fully. If any leaks occur, turn off the tap and remove the nut. Retighten the nut carefully after checking the seal. In order to prevent the water leaks and resultant damages, keep the taps closed when you do not use the product.

4.1.5 Connecting the drain hose to the drain

- Attach the end of the drain hose directly to waste water drain, lavatory or bathtub.



CAUTION: Your drain house will be flooded if the hose comes out of its housing during water discharge. Moreover, there is risk of scalding due to high washing temperatures! In order to prevent such situations and make sure that the machine performs water intake and discharge processes without any problem, fix the drain hose securely.

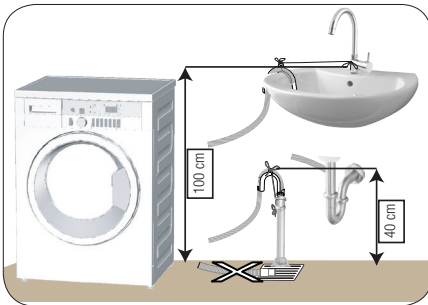

- Connect the drain hose to a minimum height of 40 cm and a maximum height of 100 cm.
- In case the drain hose is elevated after laying it on the floor level or close to the ground (less than 40 cm above the ground), water discharge becomes more difficult and the laundry may come out excessively wet. Therefore, follow the heights described in the figure.

- To prevent the waste water to go back into the machine again and to ensure easy drainage, do not immerse the end of the hose into the waste water or do not insert it into the drain for more than 15 cm. If it is too long, cut it short.
- The end of the hose should not be bent, it should not be stepped on and the hose must not be pinched between the drain and the machine.
- If the length of the hose is too short, use it by adding an original extension hose. Length of the hose may not be longer than 3.2 m. To avoid water leak failures, the connection between the extension hose and the drain hose of the product must be fitted well with an appropriate clamp as not to come off and leak.

4.1.6 Adjusting the feet



CAUTION: In order to ensure that the product operates more silently and vibration-free, it must stand level and balanced on its feet. Balance the machine by adjusting the feet. Otherwise, the product may move from its place and cause crushing and vibration problems.

CAUTION: Do not use any tools to loosen the lock nuts. Otherwise, they will get damaged.

- 1 Loosen the lock nuts on the feet by hand.
- 2 Adjust the feet until the product stands in a stable and balanced way.
- 3 Tighten all lock nuts by hand again.

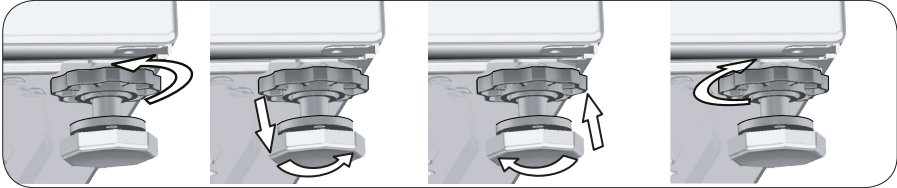

4.1.7 Electrical connection

Connect the product to a grounded outlet protected by a 16 A fuse. Our company shall not be liable for any damages that will arise when the product is used without grounding in accordance with the local regulations.

- Connection must comply with national regulations.
- The wiring for the electrical outlet circuit must be sufficient to meet the appliance requirements. Use of a Ground Fault Circuit Interrupter (GFCI) is recommended.
- Power cable plug must be within easy reach after installation.
- If the current value of the fuse or breaker in the house is less than 16 Amps, have a qualified electrician install a 16 Amp fuse.
- The voltage specified in the "Technical specifications" section must be equal to your mains voltage.
- Do not make connections via extension cables or multi-plugs.



CAUTION: Damaged power cables must be replaced by the Authorised Service Agents.

4.1.8 Initial use



Before starting to use the product make sure that the preparations are made which are in line with the "Important Safety and Environment Instructions" and the instructions in the "Installation" section.

To prepare the product for washing laundry, perform first operation in Drum Cleaning programme. If this program is not available in your machine, apply the method which is described in the section 4.4.2.



Use an anti-limescale suitable for the washing machines.

Some water might have remained in the product due to the quality control processes in the production. It is not harmful for the product.

4.2 Preparation

4.2.1 Sorting the laundry

- * Sort laundry according to type of fabric, color, and degree of soiling and allowable water temperature.
- * Always obey the instructions given on the garment tags.

4.2.2 Preparing laundry for washing

- Laundry items with metal attachments such as, underwired bras, belt buckles or metal buttons will damage the machine. Remove the metal pieces or wash the clothes by putting them in a laundry bag or pillow case.
- Take out all substances in the pockets such as coins, pens and paper clips, and turn pockets inside out and brush. Such objects may damage the product or cause noise problem.
- Put small size clothes such as infant's socks and nylon stockings in a laundry bag or pillow case.
- Place curtains in without compressing them. Remove curtain attachment items.
- Fasten zippers, sew loose buttons and mend rips and tears.
- Wash "machine washable" or "hand washable" labeled products only with an appropriate programme.
- Do not wash colours and whites together. New, dark coloured cottons release a lot of dye. Wash them separately.
- Tough stains must be treated properly before washing. If unsure, check with a dry cleaner.
- Only use the dyes / color changers and descaling agents which are appropriate to machine wash. Always follow the instructions on the package.
- Wash trousers and delicate laundry turned inside out.
- Keep laundry items made of Angora wool in the freezer for a few hours before washing. This will reduce pilling.
- Laundry that are subjected to materials such as flour, lime dust, milk powder, etc. intensely must be shaken off before placing into the machine. Such dusts and powders on the laundry may build up on the inner parts of the machine in time and can cause damage.

4.2.3 Things to be done for energy saving

Following information will help you use the product in an ecological and energy-efficient manner.

- Operate the product in the highest capacity allowed by the programme you have selected, but do not overload; see, "Programme and consumption table". See, "Programme and consumption table"
- Always follow the instructions on the detergent packaging.
- Wash slightly soiled laundry at low temperatures.
- Use faster programmes for small quantities of lightly soiled laundry.
- Do not use prewash and high temperatures for laundry that is not heavily soiled or stained.
- If you plan to dry your laundry in a dryer, select the highest spin speed recommended during washing process.
- Do not use more detergent than the recommended amount specified on its package.

4.2.4 Loading the laundry

1. Open the laundry cover.
2. Put the laundry items into the machine in a loose manner.
3. Push and close the loading cover until you hear the locking sound. Ensure that no items are caught in the door. The loading door is locked while a programme is running. The door can only be opened a while after the programme comes to an end.

4.2.5 Correct load capacity

The maximum load capacity depends on the type of laundry, the degree of soiling and the washing programme desired.

Machine automatically adjusts the water amount according to the weight of the laundry put inside it.



WARNING: Follow the information in the "Programme and consumption table". When overloaded, machine's washing performance will drop. Moreover, noise and vibration problems may occur.

4.2.6 Using detergent and softener



When using detergent, softener, starch, fabric dye, bleach and decolorant, descaling agents; read the manufacturer's instructions written on the package and follow the dosages specified. Use measuring cup if available.

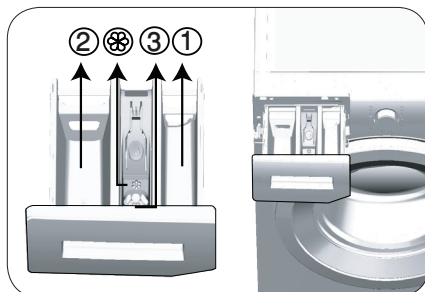

The detergent drawer is composed of three compartments:

- (1) for prewash
- (2) for main wash
- (3) for softener
- (⊗) in addition, there is a siphon piece in the softener compartment.

Detergent, softener and other cleaning agents

- Add detergent and softener before starting the washing programme.
 - While the washing cycle is in progress, do not leave the detergent dispenser open!
 - When using a programme without prewash, do not put any detergent into the prewash compartment (compartment nr. "1").
 - In a programme with prewash, do not put liquid detergent into the prewash compartment (compartment nr. "1").
 - Do not select a programme with prewash if you are using a detergent bag or dispensing ball. Place the detergent bag or the dispensing ball directly among the laundry in the machine.
- If you are using liquid detergent, do not forget to place the liquid detergent container into the main wash compartment (compartment number "2").

Choosing the detergent type

Detergent type to be used depends on the fabric type and color.

- Use different detergents for coloured and white laundry.
- Wash your delicate clothes only with special detergents (liquid detergent, wool shampoo, etc.) used solely for delicate clothes.
- When washing dark coloured clothes and quilts, it is recommended to use liquid detergent.
- Wash woolens with special detergent made specifically for woolens.



CAUTION: Use only detergents manufactured specifically for washing machines.

CAUTION: Do not use soap powder.

Adjusting detergent amount

The amount of washing detergent to be used depends on the amount of laundry, the degree of soiling and water hardness.

- Do not use amounts exceeding the dosage quantities recommended on the detergent package to avoid problems of excessive foam, poor rinsing, financial savings and finally, environmental protection.
- Use lesser detergent for small amounts or lightly soiled clothes.

Using softeners

Pour the softener into the softener compartment of the detergent drawer.

- Do not exceed the (>max<) level sign on the softener compartment.
- If the softener has lost its fluidity, dilute it with water before putting it in the detergent drawer.

Using liquid detergents

If the product contains a liquid detergent cup:

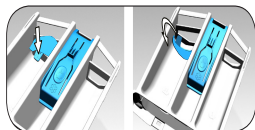

• When you want to use liquid detergent, press on the point shown to rotate the apparatus. The part that falls off will function as a barrier for the liquid detergent.

- Put the liquid detergent container into the compartment no "2".
- If the liquid detergent lost its fluidity, dilute it with water before putting it into the detergent container.

If the product does not contain a liquid detergent cup:

- Do not use liquid detergent for the prewash in a programme with prewash.
- Liquid detergent stains your clothes when used with Delayed Start function. If you are going to use the Delayed Start function, do not use liquid detergent.

Using gel and tablet detergent

- If the gel detergent thickness is fluidal and your machine does not contain a special liquid detergent cup, put the gel detergent into the main wash detergent compartment during first water intake. If your machine contains a liquid detergent cup, fill the detergent into this cup before starting the programme.
- If the gel detergent thickness is not fluidal or in the shape of capsule liquid tablet, put it directly into the drum before washing.
- Put tablet detergents into the main wash compartment (compartment nr. "2") or directly into the drum before washing.

Using starch

- Put the liquid soda, powder soda or the fabric dye into the softener compartment. Do not use softener and starch together in a washing cycle. Wipe the inside of the machine with a damp and clean cloth after using starch.

Using limescale remover

- When required, use limescale removers manufactured specifically for washing machines only.

Using bleaches

Add the bleach at the beginning of the washing cycle by selecting a prewash program. Do not put detergent in the prewash compartment. As an alternative application, select a programme with extra rinse and add the bleaching agent while the machine is taking water from the detergent compartment during first rinsing step.

- Do not use bleaching agent and detergent by mixing them.
- Use just a little amount (approx. 50 ml) of bleaching agent and rinse the clothes very well as it causes skin irritation. Do not pour the bleach onto the laundry and do not use it with the colored items.
- When using oxygen-based decolorant, select a program which washes the laundry at a low temperature.
- Oxygen-based decolorant can be used with the detergent; however, if it is not at the same consistence, first put detergent in the compartment number "2" in the detergent dispenser and wait for the machine to flush the detergent when taking in water. While the machine continues taking in water, add decolorant in the same compartment.

4.2.7 Tips for efficient washing

| | | Clothes | | | |
|----------------------|--|--|---|---|--|
| | | Light Colours and Whites | Colours | Black/Dark Colours | Delicates/Woolens/Silks |
| | | (Recommended temperature range based on soiling level: 40-90 °C) | (Recommended temperature range based on soiling level: cold -40 °C) | (Recommended temperature range based on soiling level: cold -40 °C) | (Recommended temperature range based on soiling level: cold -30 °C) |
| Soiling Level | Heavily Soiled (difficult stains such as grass, coffee, fruits and blood.) | It may be necessary to pre-treat the stains or perform prewash. Powder and liquid detergents recommended for whites can be used at dosages recommended for heavily soiled clothes. It is recommended to use powder detergents to clean clay and soil stains and the stains that are sensitive to bleaches. | Powder and liquid detergents recommended for colors can be used at dosages recommended for heavily soiled clothes. It is recommended to use powder detergents to clean clay and soil stains and the stains that are sensitive to bleaches. Use detergents without bleach. | Liquid detergents suitable for colors and dark colors can be used at dosages recommended for heavily soiled clothes. | Prefer liquid detergents produced for delicate clothes. Woolen and silk clothes must be washed with special woolen detergents. |
| | Normally Soiled (For example, stains caused by body on collars and cuffs) | Powder and liquid detergents recommended for whites can be used at dosages recommended for normally soiled clothes. | Powder and liquid detergents recommended for colors can be used at dosages recommended for normally soiled clothes. Detergents which do not contain bleach should be used. | Liquid detergents suitable for colors and dark colors can be used at dosages recommended for normally soiled clothes. | Prefer liquid detergents produced for delicate clothes. Woolen and silk clothes must be washed with special woolen detergents. |
| | Lightly Soiled (No visible stains exist.) | Powder and liquid detergents recommended for whites can be used at dosages recommended for lightly soiled clothes. | Powder and liquid detergents recommended for colors can be used at dosages recommended for lightly soiled clothes. Detergents which do not contain bleach should be used. | Liquid detergents suitable for colors and dark colors can be used at dosages recommended for lightly soiled clothes. | Prefer liquid detergents produced for delicate clothes. Woolen and silk clothes must be washed with special woolen detergents. |

4.3 Operating the product

4.3.1 Control panel

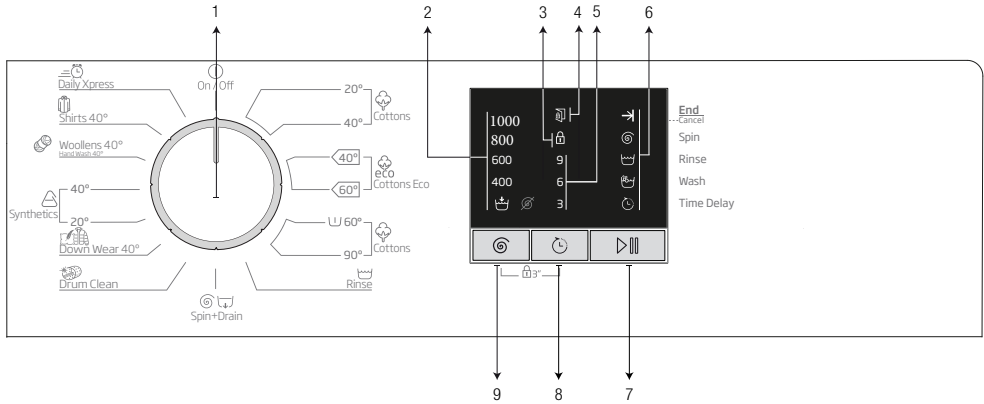

- 1 - Programme Selection knob (Uppermost position On / Off)
- 2 - Spin Speed Indicator LEDs
- 3 - Child Lock Enabled LED
- 4 - Door Lock Enabled LED

- 5 - Delayed Start Indicator LEDs
- 6 - Programme Follow-up LEDs
- 7 - Start / Pause Button
- 8 - Delayed Start Setting Button
- 9 - Spin Speed Adjustment button

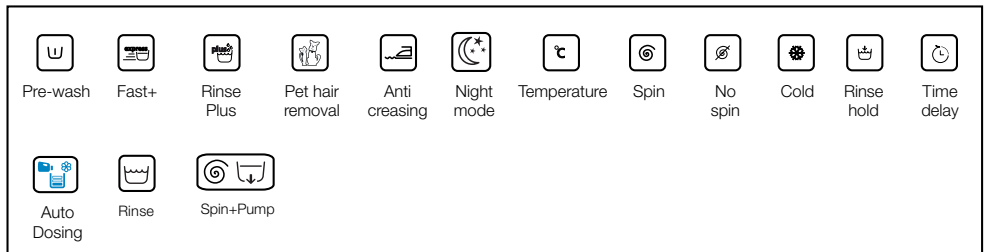

4.3.2 Preparing the machine

1. Make sure that the hoses are connected tightly.
2. Plug in your machine.
3. Turn the tap on completely.
4. Place the laundry in the machine.
5. Add detergent and fabric softener.

4.3.3 Programme selection and tips for efficient washing

1. Select the programme suitable for the type, quantity and soiling degree of the laundry in accordance with the "Programme and consumption table" and the temperature table below.
2. Select the desired programme with the Programme Selection knob.





4.3.4 Programme and consumption table

| EN | | | | | | | |
|----------------------|------|----------------|---------------------------|-----------------------|--------------------------|---------------|------|
| Programme | | Max. Load (kg) | Programme Duration (~min) | Water Consumption (l) | Energy Consumption (kWh) | Max. Speed*** | |
| Cottons | 90 | 6 | 180 | 83 | 1,95 | 1000 | |
| | 40 | 6 | 180 | 81 | 1,00 | 1000 | |
| | 20 | 6 | 180 | 81 | 0,50 | 1000 | |
| Prewash-Cottons | | 60 | 6 | 200 | 92 | 1,80 | 1000 |
| Cottons Eco | 60** | 6 | 255 | 46,4 | 0,918 | 1000 | |
| | 60** | 3 | 205 | 35,4 | 0,490 | 1000 | |
| | 40** | 3 | 205 | 35,0 | 0,485 | 1000 | |
| Synthetics | 40 | 2,5 | 120 | 66 | 0,75 | 1000 | |
| | 20 | 2,5 | 120 | 66 | 0,25 | 1000 | |
| Daily Xpress | | 30 | 6 | 28 | 60 | 0,15 | 1000 |
| Woollens / Hand Wash | | 40 | 1,5 | 65 | 45 | 0,45 | 1000 |
| Down Wear | | 40 | 1,5 | 105 | 85 | 0,80 | 1000 |
| Shirts | | 40 | 2,5 | 80 | 42 | 0,60 | 800 |
| Drum Clean | | 90 | - | 160 | 67 | 2,1 | 600 |

** : Energy Label programme (EN 60456 Ed.3)

***: If maximum spin speed of the machine is lower then this value, you can only select up to the maximum spin speed.

- : See the programme description for maximum load.

| | |
|--|--|
|  | ** "Cotton Economic 40°C and Cotton Economic 60°C are standard programmes." These programmes are known as '40°C cotton standard programme' and '60°C cotton standard programme' and indicated with the   symbols on the panel. |
|  | Water and power consumption may vary subject to the changes in water pressure, water hardness and temperature, ambient temperature, type and amount of laundry, spin speed, and changes in electric voltage. |
| | Depending on the amount of laundry you have loaded into your machine, there may be a difference of 1-1.5 hours between the duration shown in the Programme and consumption table and the actual washing duration. Duration will be automatically updated soon after the washing starts. |

| Indicative values for Synthetics programmes (EN) | | | | | | |
|--|-----------|-----------------------|--------------------------|----------------------------|---|---|
| | Load (kg) | Water Consumption (l) | Energy Consumption (kWh) | Programme Duration (min) * | Remaining Moisture Content (%) ** ≤ 1000 rpm | Remaining Moisture Content (%) ** > 1000 rpm |
| Synthetics 40 | 2,5 | 66 | 0,75 | 105/140 | 45 | 40 |
| Synthetics 20 | 2,5 | 66 | 0,25 | 105/140 | 45 | 40 |

* You can see the washing time of the programme you have selected on the display of the machine. It is normal that small differences may occur between the time shown on the display and the real washing time.

** Remaining moisture content values may differ according to the selected spin speed.

4.3.5 Main programmes

Depending on the type of fabric, use the following main programmes.

- **Cottons**

Use this programme for your cotton laundry (sheets, bedlinen, towels, bathrobes, underwear etc.). Your laundry will be washed with vigorous washing action for a longer washing cycle.

- **Synthetics**

Use to wash your synthetic clothes (shirts, blouses, synthetic/cotton blends, etc.). Your laundry will be washed with a gentle action for a shorter washing cycle when compared to the Cottons programme. For curtains and tulle, it is recommended to use Synthetics 20°C or 40°C programme.

- **Woolens / Hand Wash**

Use to wash your woolen/delicate laundry. Your laundry will be washed with a very gentle washing action in order not to damage the clothes.

4.3.6 Additional programmes

For special cases, additional programmes are available in the machine.



Additional programmes may differ according to the model of the machine.

- **Cottons Eco**

Use this programme to wash your laundry washable in cottons programme for a longer time, still with a very good performance for saving purposes.



Cotton Eco programme consumes less energy compared to other cotton programmes.

- **Prewash-Cottons**

Use this programme only for heavily soiled cotton clothes. Add detergent into the prewash compartment.

- **Daily Xpress**

Use this programme to wash your lightly soiled cotton clothes in a short time.

• Shirts

This programme is used to wash the shirts made from cotton, synthetic and synthetic blended fabrics altogether. It reduces wrinkles. Pre-treatment algorithm is executed.

- Apply the pre-treatment chemical on your garments directly or add it together with detergent when the machine starts to take water from the main washing compartment. Thus the machine will wash them in a short period of time and expected lifespan of your shirts will extend.

• Down Wear

Use this programme to wash your coats, vest, jackets etc. containing feathers with a "machine-washable" label on them. Thanks to special spinning profiles, it is ensured that the water reaches the air gaps amongst the feathers.

• Drum Clean

Use regularly (once in every 1-2 months) to clean the drum and provide the required hygiene. Operate the programme while the machine is completely empty. To obtain better results, put powder lime-scale remover for washing machines into the detergent compartment no. "2". When the programme is over, leave the loading door ajar so that the inside of the machine gets dry.



This is not a washing programme. It is a maintenance programme.

Do not run the programme when there is something in the machine. If you try to do so, the machine detects that there is load inside and aborts the programme.

4.3.7 Special programmes

For specific applications, select any of the following programmes.

• Rinse

Use when you want to rinse or starch separately.

• Spin+Drain

You can use this function to remove the water on the garment or drain the water in the machine. Before selecting this programme, select the desired spin speed and press Start / Pause button. First, the machine will drain the water inside of it. Then, it will spin the laundry with the set spin speed and drain the water coming out of them.

If you wish to drain only the water without spinning your laundry, select the Pump+Spin programme and then select the No Spin function with the help of Spin Speed Adjustment button. Press Start / Pause button.



Use a lower spin speed for delicate laundries.

4.3.8 Speed selection

Whenever a new programme is selected, the recommended spin speed of the selected programme is displayed on the spin speed indicator.

To decrease the spin speed, press the Spin Speed Adjustment button. Spin speed decreases gradually. Then, depending on the model of the product, "Rinse Hold" and "No Spin" options appear on the display. When "No Spin" is selected, the rinse level indicator lights will not turn on.

Rinse hold

If you are not going to unload your clothes immediately after the programme completes, you can use rinse hold function to keep your laundry in the final rinsing water in order to prevent them from getting wrinkled when there is no water in the machine. Press Start / Pause button after this process if you want to drain the water without spinning your laundry. Programme will resume and complete after draining the water.

If you want to spin the laundry held in water, adjust the Spin Speed and press Start / Pause button. The programme will resume. Water is drained, laundry is spun and the programme is completed.



If the programme has not reached the spinning step, you can change the speed without switching the machine to Pause mode.

4.3.9 Delayed Start

With the Delayed Start function the startup of the programme may be delayed up to 3, 6 or 9 hours.



Do not use liquid detergents when you set Delayed Start! There is the risk of staining of the clothes.

1. Open the loading door, place the laundry and put detergent, etc.
2. Select a washing programme and spin speed.
3. Set the desired time by pressing the Delayed Start button. When the button is pressed once, 3 hours delayed start is selected. When the same button is pressed again, 6 hours delay is selected, and when it is pressed for the third time, 9 hours delayed start is selected. If you press the Delayed Start button once again, Delayed Start function will be canceled.
4. Press Start / Pause button. Previous delayed start time light turns off and next delayed start time light turns on after every 3 hours.
5. At the end of the countdown, all delayed start lights will turn off and the selected programme will start.



You can switch the machine to pause mode and add laundry during the delayed start period.

Changing the delayed start period

If you want to change the time during countdown, you will need to cancel the programme and set the delay time again.

Canceling the Delayed Start function

If you want to cancel the delayed start countdown and start the programme immediately:

1. Turn the Programme Selection knob to any programme. Thus, Delayed Start function will be canceled. The End/Cancel light flashes continuously.
2. Then, select the programme you want to run again.
3. Press Start / Pause button to start the programme.

4.3.10 Starting the programme

1. Press Start / Pause button to start the programme.
2. Programme follow-up light showing the startup of the programme will turn on.

4.3.11 Child Lock

Use Child Lock function to prevent children from tampering with the machine. Thus you can avoid any changes in a running programme.



If the Programme Selection knob is rotated when the child lock is active, "Child Lock Enabled LED" will flash 3 times. The Child Lock does not allow any change in the programmes or the selected speed.

Even if another programme is selected with the Programme Selection knob while the Child Lock is active, previously selected programme will continue running.

When the Child Lock is active and the machine is running, you can switch the machine to Pause mode without deactivating the Child Lock by turning the Programme Selection knob to On / Off position. When you turn the Programme Selection knob afterwards, the programme will resume.

To activate the Child Lock:

Press and hold Speed and Delayed Start buttons for 3 seconds. While you are holding for 3 seconds, the "Child Lock Enabled LED" will flash. You can release the buttons when the LEDs become permanently on.

To deactivate the Child Lock:

Press and hold Speed and Delayed Start buttons for 3 seconds while any programme is running. While you are holding for 3 seconds, the "Child Lock Enabled LED" will flash. You can release the buttons when the LED turns off completely.



In addition to the method above, to deactivate the Child Lock, switch the Programme Selection knob to On / Off position when no programme is running, and select another programme.

Child Lock is not deactivated after power failures or when the machine is unplugged.

4.3.12 Progress of programme

Progress of a running programme can be followed from the Programme Follow-up indicator. At the beginning of every programme step, the relevant indicator light will turn on and light of the completed step will turn off.

You can change the speed settings without stopping the programme flow while the programme is running. To do this, the change you are going to make must be in a step after the running programme step. If the change is not compatible, relevant lights will flash for 3 times.



If the machine does not proceed to the spinning step, the Rinse Hold function might be active or the automatic unbalanced load detection system might be activated due to the unbalanced distribution of the laundry in the machine.

4.3.13 Loading door lock

There is a locking system on the loading door of the machine that prevents opening of the loading door in cases when the water level is unsuitable.

Loading door light will start flashing when the machine is switched to Pause mode. The machine checks the level of the water inside. If the level is suitable, the Loading Door light turns off and the loading door can be opened within 1-2 minutes.

If the level is unsuitable, the Loading Door light remains on and the loading door cannot be opened. If you are obliged to open the Loading Door while the Loading Door light is on, you must cancel the current programme. See: "Cancelling the programme"

4.3.14 Changing the selections after programme has started

Switching the machine to pause mode

Press the Start / Pause button to switch the machine to pause mode while a programme is running. The light of the step which the machine is in starts flashing in the Programme Follow-up indicator to show that the machine has been switched to the pause mode.

Additionally, when the loading door is openable, the Loading Door light turns off completely.

Changing the speed settings

You can change the speed settings of the programme that is currently running. See "Speed selection".



If no change is allowed, the relevant light will flash 3 times.

Adding or taking out laundry

You can load/unload laundry when a programme is running if the water level is appropriate to open the door. To do this:

1. Press Start / Pause button to switch the machine to pause mode. The programme follow-up light of the relevant step during which the machine was switched into the pause mode will flash.
2. Wait until the Loading Door can be opened.
3. Open the Loading Door and add or take out the laundry.
4. Close the Loading Door.
5. Make changes in speed settings, if necessary.
6. Press Start / Pause button to start the machine.

4.3.15 Cancelling the programme

To cancel the programme, turn the Programme Selection knob to select another programme. Previous programme will be cancelled. End / Cancel light will flash continuously to notify that the programme has been canceled.

Your machine will end the programme when you turn the Programme Selection knob; however, it does not drain the water inside. When you select and start a new programme, the newly selected programme will start depending on the step the previous programme was canceled in. For example, it may take in additional water or continue to wash with the water inside.



Some programmes may start by discharging the water inside the machine. Depending on the step where the programme was canceled in, you may have to put detergent and softener again for the programme you have selected anew.

4.3.16 End of programme

When the programme ends, "End" LED becomes on at the Programme Follow-up indicator.

1. Wait until the "Door Lock Enabled LED" goes off completely.
2. To switch off the machine, turn the Programme Selection Knob to On/Off position.
3. Take out your laundry and close the loading door. Your machine is ready for the next washing cycle.

4.3.17 Your machine features "Pause Mode".

After you switch on your machine with the programme selection button (by switching the button to a different position than the On/Off position), if no programme is started or no other procedure is performed in the selection step or no action is taken within approx. 2 minutes after the selected programme ends, your machine will switch to energy saving mode automatically. The brightness of the indicator lights will decrease. Also, if your product has a display that shows programme time, this display will be completely turned off. If you turn the Programme Selection knob or touch any button, lights and display will switch back to previous condition. The selections which you make when exiting from the energy efficiency may change. Please check the correctness of your selections before starting the programme. If necessary, please make your settings again. This is not an error.

4.4 Maintenance and cleaning

Service life of product extends and frequently experienced problems will be reduced if it is cleaned at regular intervals.

4.4.1 Cleaning the detergent drawer

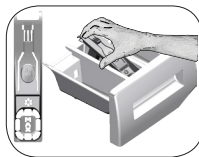

Clean the detergent drawer at regular intervals (every 4-5 washing cycles) as shown below in order to prevent accumulation of powder detergent in time.

Lift the rear part of the siphon to remove it as illustrated.

If more than normal amount of water and softener mixture starts to gather in the softener compartment, the siphon must be cleaned.

- 1 Press the dotted point on the siphon in the softener compartment and pull towards you until the compartment is removed from the machine.
- 2 Wash the detergent drawer and the siphon with plenty of lukewarm water in a washbasin. In order to prevent the residues to contact your skin, clean it with an appropriate brush by wearing a pair of gloves.
- 3 Insert the drawer back into its place after cleaning and make sure that it is seated well.

4.4.2 Cleaning the loading door and the drum

For products with drum cleaning programme, please see Operating the product - Programmes.



Repeat Drum Cleaning process in every 2 months.

Use an detergent / anti-limescale suitable for the washing machines.



After every washing make sure that no foreign substance is left in the drum. If the holes on the bellow shown in the figure is blocked, open the holes using a toothpick.

Foreign metal substances will cause rust stains in the drum. Clean the stains on the drum surface by using cleaning agents for stainless steel.

Never use steel wool or wire wool. These will damage the painted, chromated and plastic surfaces.

4.4.3 Cleaning the body and control panel

Wipe the body of the machine with soapy water or non-corrosive mild gel detergents as necessary, and dry with a soft cloth.

Use only a soft and damp cloth to clean the control panel.

4.4.4 Cleaning the water intake filters

There is a filter at the end of each water intake valve at the rear of the machine and also at the end of each water intake hose where they are connected to the tap. These filters prevent foreign substances and dirt in the water to enter the washing machine. Filters should be cleaned as they do get dirty.

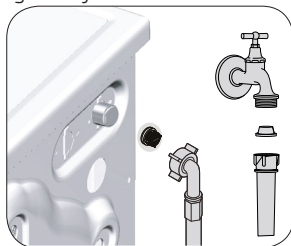

1. Close the taps.
2. Remove the nuts of the water intake hoses to access the filters on the water intake valves. Clean them with an appropriate brush. If the filters are too dirty, remove them from their places with a pliers and clean in this way.
3. Take out the filters on the flat ends of the water intake hoses together with the gaskets and clean thoroughly under running water.
4. Replace the seals and filters carefully and tighten their nuts by hand.

4.4.5 Draining remaining water and cleaning the pump filter

The filter system in your machine prevents solid items such as buttons, coins and fabric fibers clogging the pump impeller during discharge of washing water. Thus, the water will be discharged without any problem and the service life of the pump will extend.

If the machine fails to drain water, the pump filter is clogged. Filter must be cleaned whenever it is clogged or in every 3 months. Water must be drained off first to clean the pump filter.

In addition, prior to transporting the machine (e.g., when moving to another house) and in case of freezing of the water, water may have to be drained completely.



CAUTION: Foreign substances left in the pump filter may damage your machine or may cause noise problem.

CAUTION: If the product is not being used, shut the tap shut, remove mains pipe and drain the water inside the machine against any likely freezing.

CAUTION: After each use, turn off the water tap to which the mains hose is connected.

In order to clean the dirty filter and discharge the water:

1 Unplug the machine to cut off the supply power.



CAUTION: Temperature of the water inside the machine may rise up to 90 °C. To avoid the burning risk, clean the filter after the water inside the machine is cooled down.

2. Open the filter cover.

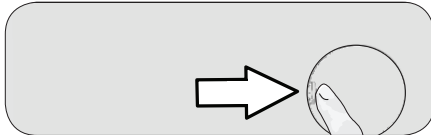

3 Follow the below procedures in order to drain water.

The product does not have an emergency water drain hose, in order to drain the water:

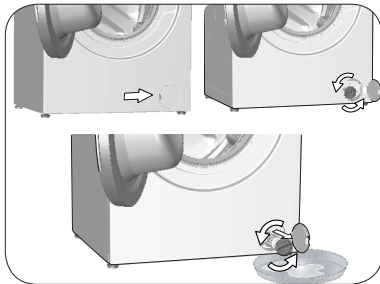

- In order to collect the water to flow out of the filter, place a large vessel in front of the filter.
- Turn and loosen the pump filter until water starts to flow (counterclockwise). Fill the flowing water into the container you have placed in front of the filter. Always keep a piece of cloth handy to absorb any spilled water.
- When the water inside the machine is finished, take out the filter completely by turning it.

4. Clean any residues inside the filter as well as fibers, if any, around the pump impeller region.

5. Replace the filter.

6. If the filter cap is composed of two pieces, close the filter cap by pressing on the tab. If it is one piece, seat the tabs in the lower part into their places first, and then press the upper part to close

5 Troubleshooting

| Problem | Reason | Solution |
|--|---|---|
| Program does not start after closing the door. | Start / Pause / Cancel button was not pressed. | <ul style="list-style-type: none"> * Press the Start / Pause / Cancel button. |
| | It may be difficult to close the loading door in case of excessive loading. | <ul style="list-style-type: none"> Reduce the amount of laundry and make sure that the loading door is closed properly. |
| Programme cannot be started or selected. | Washing machine has switched to self protection mode due to a supply problem (line voltage, water pressure, etc.). | <ul style="list-style-type: none"> To cancel the programme, turn the Programme Selection knob to select another programme. Previous programme will be canceled. (see. "Cancellation of program") |
| Water in the machine. | Some water might have remained in the product due to the quality control processes in the production. | <ul style="list-style-type: none"> This is not a failure; water is not harmful to the machine. |
| The machine enters standby mode after the programme starts or it does not take in water. | Tap is turned off. | <ul style="list-style-type: none"> Turn on the taps. |
| | Water inlet hose is bent. | <ul style="list-style-type: none"> Flatten the hose. |
| | Water inlet filter is clogged. | <ul style="list-style-type: none"> Clean the filter. |
| | Loading door may be open. | <ul style="list-style-type: none"> Close the door. |
| | The water connection may be wrong or water may be cut off (When the water is cut off, washing or rinsing LEDs flash). | <ul style="list-style-type: none"> Check the water connection. If the water is cut off, press the Start/Pause key after the water has been supplied again to resume the operation from standby mode. |
| Machine does not drain water. | Water drain hose might be clogged or twisted. | <ul style="list-style-type: none"> Clean or flatten the hose. |
| | Pump filter is clogged. | <ul style="list-style-type: none"> Clean the pump filter. |
| Machine vibrates or makes noise. | Machine might be standing unbalanced. | <ul style="list-style-type: none"> Adjust the feet to level the machine. |
| | A hard substance might have entered into the pump filter. | <ul style="list-style-type: none"> Clean the pump filter. |
| | Transportation safety bolts are not removed. | <ul style="list-style-type: none"> Remove the transportation safety bolts. |
| | Laundry quantity in the machine might be too little. | <ul style="list-style-type: none"> Add more laundry to the machine. |
| | Machine might be overloaded with laundry. | <ul style="list-style-type: none"> Take out some of the laundry from the machine or distribute the load by hand to balance it homogenously in the machine. |
| There is water leaking from the bottom of the washing machine. | Water drain hose might be clogged or twisted. | <ul style="list-style-type: none"> Clean or flatten the hose. |
| | Pump filter is clogged. | <ul style="list-style-type: none"> Clean the pump filter. |
| Machine stopped shortly after the programme started. | Machine might have stopped temporarily due to low voltage. | <ul style="list-style-type: none"> It will resume running when the voltage restores to the normal level. |
| Machine directly discharges the water it takes in. | Draining hose might not be at adequate height. | <ul style="list-style-type: none"> Connect the water draining hose as described in the operation manual. |
| No water can be seen in the machine during washing. | The water level is not visible from outside of the washing machine. | <ul style="list-style-type: none"> This is not a failure. |
| Loading door cannot be opened. | Door lock is activated because of the water level in the machine. | <ul style="list-style-type: none"> Drain the water by running the Pump or Spin programme. |
| | Machine is heating up the water or it is at the spinning cycle. | <ul style="list-style-type: none"> Wait until the programme completes. |
| | Child lock is engaged. Door lock will be deactivated a couple of minutes after the programme has come to an end. | <ul style="list-style-type: none"> Wait for a couple of minutes for deactivation of the door lock. |
| | Loading door may be stuck because of the pressure it is subjected to. | <ul style="list-style-type: none"> Grab the handle and push and pull the loading door to release and open it. |

| Problem | Reason | Solution |
|--|--|--|
| Washing takes longer time than specified in the manual.(*) | Water pressure is low. | <ul style="list-style-type: none"> Machine waits until taking in adequate amount of water to prevent poor washing quality due to the decreased amount of water. Therefore, the washing time extends. |
| | Voltage might be low. | <ul style="list-style-type: none"> Washing time is prolonged to avoid poor washing results when the supply voltage is low. |
| | Input temperature of water might be low. | <ul style="list-style-type: none"> Required time to heat up the water extends in cold seasons. Also, washing time can be lengthened to avoid poor washing results. |
| | Number of rinses and/or amount of rinse water might have increased. | <ul style="list-style-type: none"> Machine increases the amount of rinse water when good rinsing is needed and adds an extra rinsing step if necessary. |
| | Excessive foam might have occurred and automatic foam absorption system might have been activated due to too much detergent usage. | <ul style="list-style-type: none"> Use recommended amount of detergent. |
| Programme time does not countdown. (On models with display) (*) | Timer may stop during water intake. | <ul style="list-style-type: none"> Timer indicator will not countdown until the machine takes in adequate amount of water. The machine will wait until there is sufficient amount of water to avoid poor washing results due to lack of water. Timer indicator will resume countdown after this. |
| | Timer may stop during heating step. | <ul style="list-style-type: none"> Timer indicator will not countdown until the machine reaches the selected temperature. |
| | Timer may stop during spinning step. | <ul style="list-style-type: none"> Automatic unbalanced load detection system might be activated due to the unbalanced distribution of the laundry in the drum. |
| Programme time does not countdown. (*) | There might be unbalanced load in the machine. | <ul style="list-style-type: none"> Automatic unbalanced load detection system might be activated due to the unbalanced distribution of the laundry in the drum. |
| Machine does not switch to spinning step. (*) | There might be unbalanced load in the machine. | <ul style="list-style-type: none"> Automatic unbalanced load detection system might be activated due to the unbalanced distribution of the laundry in the drum. |
| | The machine will not spin if water is not drained completely. | <ul style="list-style-type: none"> Check the filter and the draining hose. |
| | Excessive foam might have occurred and automatic foam absorption system might have been activated due to too much detergent usage. | <ul style="list-style-type: none"> Use recommended amount of detergent. |
| Washing performance is poor: Laundry turns gray. (**) | Insufficient amount of detergent has been used over a long period of time. | <ul style="list-style-type: none"> Use the recommended amount of detergent appropriate for water hardness and the laundry. |
| | Washing was made at low temperatures for a long time. | <ul style="list-style-type: none"> Select the proper temperature for the laundry to be washed. |
| | Insufficient amount of detergent is used with hard water. | <ul style="list-style-type: none"> Using insufficient amount of detergent with hard water causes the soil to stick on the cloth and this turns the cloth into gray in time. It is difficult to eliminate graying once it happens. Use the recommended amount of detergent appropriate for water hardness and the laundry. |
| | Too much detergent is used. | <ul style="list-style-type: none"> Use the recommended amount of detergent appropriate for water hardness and the laundry. |
| Washing performance is poor: Stains persist or the laundry is not whitened. (**) | Insufficient amount of detergent is used. | <ul style="list-style-type: none"> Use the recommended amount of detergent appropriate for water hardness and the laundry. |
| | Excessive laundry was loaded in. | <ul style="list-style-type: none"> Do not load the machine in excess. Load with amounts recommended in the "Programme and consumption table". |
| | Wrong programme and temperature were selected. | <ul style="list-style-type: none"> Select the proper programme and temperature for the laundry to be washed. |
| | Wrong type of detergent is used. | <ul style="list-style-type: none"> Use original detergent appropriate for the machine. |
| | Too much detergent is used. | <ul style="list-style-type: none"> Put the detergent in the correct compartment. Do not mix the bleaching agent and the detergent with each other. |

| Problem | Reason | Solution |
|---|---|--|
| Washing performance is poor: Oily stains appeared on the laundry. (**) | Regular drum cleaning is not applied. | <ul style="list-style-type: none"> • Clean the drum regularly. For this, please see 4.4.2. |
| Washing performance is poor: Clothes smell unpleasantly. (**) | Odours and bacteria layers are formed on the drum as a result of continuous washing at lower temperatures and/or in short programmes. | <ul style="list-style-type: none"> • Leave the detergent drawer as well as the loading door of the machine ajar after each washing. Thus, a humid environment favorable for bacteria cannot occur in the machine. |
| Colour of the clothes faded. (**) | Excessive laundry was loaded in. | <ul style="list-style-type: none"> • Do not load the machine in excess. |
| | Detergent in use is damp. | <ul style="list-style-type: none"> • Keep detergents closed in an environment free of humidity and do not expose them to excessive temperatures. |
| | A higher temperature is selected. | <ul style="list-style-type: none"> • Select the proper programme and temperature according to the type and soiling degree of the laundry. |
| It does not rinse well. | The amount, brand and storage conditions of the detergent used are inappropriate. | <ul style="list-style-type: none"> • Use a detergent appropriate for the washing machine and your laundry. Keep detergents closed in an environment free of humidity and do not expose them to excessive temperatures. |
| | Detergent is put in the wrong compartment. | <ul style="list-style-type: none"> • If detergent is put in the prewash compartment although prewash cycle is not selected, machine can take this detergent during rinsing or softener step. Put the detergent in the correct compartment. |
| | Pump filter is clogged. | <ul style="list-style-type: none"> • Check the filter. |
| | Drain hose is folded. | <ul style="list-style-type: none"> • Check the drain hose. |
| Laundry became stiff after washing. (**) | Insufficient amount of detergent is used. | <ul style="list-style-type: none"> • Using insufficient amount of detergent for the water hardness can cause the laundry to become stiff in time. Use appropriate amount of detergent according to the water hardness. |
| | Detergent is put in the wrong compartment. | <ul style="list-style-type: none"> • If detergent is put in the prewash compartment although prewash cycle is not selected, machine can take this detergent during rinsing or softener step. Put the detergent in the correct compartment. |
| | Detergent might be mixed with the softener. | <ul style="list-style-type: none"> • Do not mix the softener with detergent. Wash and clean the dispenser with hot water. |
| Laundry does not smell like the softener. (**) | Detergent is put in the wrong compartment. | <ul style="list-style-type: none"> • If detergent is put in the prewash compartment although prewash cycle is not selected, machine can take this detergent during rinsing or softener step. Wash and clean the dispenser with hot water. Put the detergent in the correct compartment. |
| | Detergent might be mixed with the softener. | <ul style="list-style-type: none"> • Do not mix the softener with detergent. Wash and clean the dispenser with hot water. |
| Detergent residue in the detergent drawer. (**) | Detergent is put in wet drawer. | <ul style="list-style-type: none"> • Dry the detergent drawer before putting in detergent. |
| | Detergent has gotten damp. | <ul style="list-style-type: none"> • Keep detergents closed in an environment free of humidity and do not expose them to excessive temperatures. |
| | Water pressure is low. | <ul style="list-style-type: none"> • Check the water pressure. |
| | The detergent in the main wash compartment got wet while taking in the prewash water. Holes of the detergent compartment are blocked. | <ul style="list-style-type: none"> • Check the holes and clean if they are clogged. |
| | There is a problem with the detergent drawer valves. | <ul style="list-style-type: none"> • Call the Authorised Service Agent. |
| | Detergent might be mixed with the softener. | <ul style="list-style-type: none"> • Do not mix the softener with detergent. Wash and clean the dispenser with hot water. |
| | Regular drum cleaning is not applied. | <ul style="list-style-type: none"> • Clean the drum regularly. For this, please see 4.4.2. |

| Problem | Reason | Solution |
|--|--|---|
| Too much foam forms in the machine. (**) | Improper detergents for the washing machine are being used. | • Use detergents appropriate for the washing machine. |
| | Excessive amount of detergent is used. | • Use only sufficient amount of detergent. |
| | Detergent was stored under improper conditions. | • Store detergent in a closed and dry location. Do not store in excessively hot places. |
| | Some meshed laundry such as tulle may foam too much because of their texture. | • Use smaller amounts of detergent for this type of item. |
| | Detergent is put in the wrong compartment. | • Put the detergent in the correct compartment. |
| Foam is overflowing from the detergent drawer. | Softener is being taken early. | • There may be problem in the valves or in the detergent dispenser. Call the Authorised Service Agent. |
| | Too much detergent is used. | • Mix 1 tablespoonful softener and ½ l water and pour into the main wash compartment of the detergent drawer. • Put detergent into the machine suitable for the programmes and maximum loads indicated in the "Programme and consumption table". When you use additional chemicals (stain removers, bleaches and etc), reduce the amount of detergent. |
| Laundry remains wet at the end of the programme. (*) | Excessive foam might have occurred and automatic foam absorption system might have been activated due to too much detergent usage. | • Use recommended amount of detergent. |

(*) Machine does not switch to spinning step when the laundry is not evenly distributed in the drum to prevent any damage to the machine and to its surrounding environment. Laundry should be rearranged and re-spun.

(**) Regular drum cleaning is not applied. Clean the drum regularly. See 4.4.2



CAUTION: If you cannot eliminate the problem although you follow the instructions in this section, consult your dealer or the Authorised Service Agent. Never try to repair a nonfunctional product yourself.

