

Washer-Dryer

User Manual

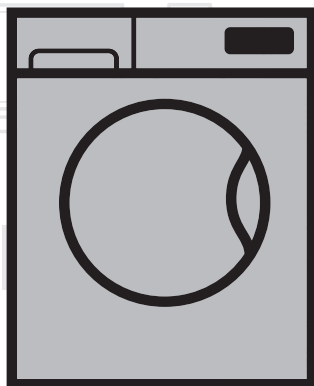

HITV 8733 B0

EN

Document Number= 2820525431_EN/01-12-17.(14:48)

beko

Please read this user manual first!

Dear Customer,

Thank you for choosing a Beko product. We hope that you get the best results from your product which has been manufactured with high quality and state-of-the-art technology. Therefore, please read this entire user manual and all other accompanying documents carefully before using the product and keep it as a reference for future use. If you handover the product to someone else, give the user manual as well. Follow all warnings and information in the user manual.

Throughout this user manual the following symbols are used:



DANGER!

Warning for electric shock.



DANGER!

Product weight warning



CAUTION

- **Warning for hazardous situations with regard to life and property.**



PRECAUTION

- **Precautions that need to be taken.**



This product was manufactured using the latest technology in environmentally friendly conditions.



INFORMATION

- *Important information or useful hints about usage.*



- *Read user manual.*



- *Packaging materials of the product are manufactured from recyclable materials in accordance with regulations.*
- *Do not dispose of the Packaging materials together with the domestic or other wastes. Take them to the packaging material collection points designated by the local authorities.*



- *Allergy UK, is the brand of British Allergy Association. Their main endorsement is the 'Seal of Approval'. When you see a product with this logo on it, you have the reassurance the product has been scientifically tested to prove it is efficient at reducing/removing allergens from the environment of allergy and asthma sufferers or the products have significantly reduced allergen/chemical content.*



APPAREL CARE

“The wool wash cycle of this machine has been approved by The Woolmark Company for the washing of machine washable wool products provided that the products are washed according to the instructions on the garment label and those issued by the manufacturer of this washing machine. M1527 “

“In UK, Eire, Hong Kong and India the Woolmark trade mark is a Certification trade mark.”

TABLE OF CONTENTS

1 Important instructions for safety and environment	7
1.1 General safety	7
1.1.1 Electrical safety	8
1.1.2 Product safety	9
1.1.3 Warnings for drying	10
1.2 Intended use	13
1.3 Children's safety	13
1.4 Compliance with WEEE Directive and disposing of the waste product	14
1.5 Package information	14
2 Your washer-dryer	15
2.1 Overview	15
2.2 Package contents	16
2.3 Technical specifications	17
3 Installation	18
3.1 Appropriate installation location	18
3.2 Removing packaging reinforcement	19
3.3 Removing the transit bolts	19
3.4 Connecting water supply	20
3.5 Connecting to the drain	21
3.6 Adjusting the feet	22
3.7 Electrical connection	22
3.8 Transportation of the product	23
4 Preparation	24
4.1 Sorting the laundry	25
4.2 Preparing laundry for washing	25
4.3 Tips for energy saving	26
4.4 Initial use	26
4.5 Correct load capacity	27
4.6 Loading the laundry	27
4.7 Using detergent and softener	28
4.7.1 Detergent drawer	28
4.7.2 Main Wash Compartment	29
4.7.3 Liquid Softener Compartment	30
4.7.4 Pre-Wash Compartment	30
4.7.5 Choosing the detergent	30
4.7.6 Adjusting the amount of detergent	31
4.7.7 Using gel and tablet detergent	31
4.7.8 Using laundry starch	32
4.7.9 Using bleaches	32
4.7.10 Using limescale remover	32
4.8 Tips for efficient washing	33

TABLE OF CONTENTS



4.9 Tips for correct drying	34
5 Operating the product	35
5.1 Control panel.....	35
5.2 Display symbols.....	36
5.3 Preparing the machine.....	36
5.4 Selecting the washing programme	37
5.5 Washing programmes	37
Cottons	38
Synthetics	38
Wool.....	39
Cottons Eco.....	39
Delicates.....	39
Hand Wash	39
Daily Xpress	40
Xpress Super Short	40
Shirts.....	41
Rinse	41
Spin+Drain	41
5.6 Temperature selection.....	42
5.7 Spin speed selection.....	43
5.7.1 If you want to spin your laundry after the Rinse Hold function:	44
5.7.2 Auxiliary function selection for drying	44
5.8 Drying programmes.....	45
Synthetic Dry	45
Cotton Dry	45
5.9 Washing and drying programmes	46
5 Kg Wash & Dry.....	46
Wash & Wear	46
BabyProtect+ Wash&Dry	47
5.10 Programme and consumption table	48
5.11 Auxiliary function selection	51
Prewash	52
Quicker Wash	52
Extra Rinse	52
5.12 Drying steps	53
5.12.1 Iron Dry 	53
5.12.2 Cupboard Dry 	53
5.12.3 Extra Dry 	53
5.12.4 Time based drying-minutes.....	53
5.13 Time display	54
5.14 End Time	54
5.15 Starting the programme.....	55
5.16 Loading door lock.....	55

TABLE OF CONTENTS

5.17 Changing the selections after programme has started	56
5.17.1 Adding laundry after the programme has started:.....	56
5.17.2 Switching the machine to pause mode:	56
5.17.3 Changing the programme selection after programme has started:.....	56
5.17.4 Changing the auxiliary function, spin speed and temperature	57
5.18 Child Lock.....	57
5.18.1 To activate the child lock:	57
5.18.2 To deactivate the child lock:	58
5.19 Cancelling the programme	58
5.20 End of programme.....	59
5.21 Your machine features a "Standby Mode".....	59
6 Maintenance and cleaning	60
6.1 Cleaning the detergent drawer	60
6.2 Cleaning the loading door and the drum	60
6.3 Cleaning the body and control panel	61
6.4 Cleaning the water intake filters.....	61
6.5 Draining remaining water and cleaning the pump filter	62
7 Troubleshooting	64

1 Important instructions for safety and environment

This section contains safety instructions that will help protect from risk of personal injury or property damage. Failure to follow these instructions shall invalidate any warranty.

1.1 General safety

CAUTION



- **This product can be used by children at and above 8 years old and by persons whose physical, sensory or mental capabilities were not fully developed or who lack experience and knowledge provided that they are supervised or trained on the safe usage of the product and the risks it brings out. Children should not play with the device. Cleaning and maintenance works should not be performed by children unless they are supervised by someone. Children under the age of 3 should be kept away unless continuously supervised.**

PRECAUTION



- Never place the product on a carpet-covered floor. Otherwise, lack of airflow beneath the machine will cause electrical parts to overheat. This will cause problems with your product.

PRECAUTION



- If the product will be used inside a wardrobe/cabinet/module, it is recommended to keep the doors of the wardrobe/cabinet/module open during operation in cases where there are no openings to provide sufficient air circulation.

INFORMATION



- *Always have the installation procedures carried out by the competent persons. Manufacturer shall not be held liable for damages that may arise from procedures carried out by unauthorised persons.*

Important instructions for safety and environment

1.1.1 Electrical safety

DANGER!



If the product has a failure, it should not be operated unless it is repaired by the Authorised Service Agent. There is the risk of electric shock!

Never wash the product by spreading or pouring water onto it! There is the risk of electric shock!

CAUTION



- If the power cable is damaged, it must be replaced by the manufacturer, after sales service or a similarly qualified person (preferably an electrician) or someone designated by the importer in order to avoid possible risks.

PRECAUTION



- Unplug the product when it is not in use.
- Never touch the plug with wet hands! Never unplug by pulling on the cable, always unplug by holding the plug.
- Product should be unplugged during installation, maintenance, cleaning and repair procedures.
- Do not make connections via extension cables or multi-plugs.

INFORMATION



- *This product is designed to resume operating in the event of powering on after a power interruption. If you wish to cancel the programme, see "Cancelling the programme" section.*

Important instructions for safety and environment

1.1.2 Product safety



DANGER!

Never open the loading door or remove the filter while there is still water in the drum. Otherwise, risk of flooding and injury from hot water will occur.



CAUTION

- The water supply and draining hoses must be securely fastened and remain undamaged. Otherwise, there is the risk of water leakage.



PRECAUTION

- The product should be used without removing the upper plate.



INFORMATION

- *Do not force open the locked loading door. Door can be opened a few minutes after the washing cycle ends. If the machine has not cooled enough at the end of the programme, loading door cannot be opened. Do not force the loading door to open. It must be left to cool itself. The loading door and the lock mechanism may get damaged.*
- *In the installation location of this product, there must not be a lockable, sliding or hinged door that will restrict the full opening of the loading door.*
- *Follow the instructions on the textile tags and on the detergent package.*
- *Use only detergents, softeners and supplements suitable for washing machines.*
- *Do not install or leave this product in places where it might be exposed to outdoor conditions.*
- *Controls must not be tampered with.*

Important instructions for safety and environment

1.1.3 Warnings for drying

DANGER!

Laundry that is previously washed, cleaned, soiled or stained with petrol / gasoline, dry cleaning solvents or other flammable or explosive substances must not be dried in the machine as they give out flammable or explosive steam. It may cause fire risk.

Laundry stained with Liquid cooking oil, acetone, alcohol, petrol, kerosene, spot removers, turpentine, waxes and wax removers must be washed in hot water with plenty of detergent before drying. It may cause fire risk.

Foam rubber (latex foam), shower caps, waterproof textiles, clothes or pillows with rubber support or rubber foam pads must not be dried with drying function. It may cause fire risk.

If you use washing ball, detergent scale, laundry clothing cages and balls in your machine, they can melt during drying. Do not use these products if drying option will be selected. It may cause fire risk.

When you use industrial chemicals for cleaning, do not use drying function. It may cause fire risk.



DANGER!

Do not touch loading door glass with bare hands after drying. There is the risk of getting burnt.

In order to maintain laundry in a temperature that will prevent them from getting damaged, a cooling step is performed as a final step. You may be exposed to hot steam if you open the door before cooling is complete. There is the risk of scalding.

If the drying programmes are interrupted (as a result of programme cancellation or power failure), laundry in the machine can be hot. Be careful.



Important instructions for safety and environment

CAUTION



- Do not stop the machine before drying programme is completed. If you have to stop the machine, remove all laundry and lay them in a suitable place to let them cool down.
- Your product is suitable to operate in ambient temperatures between 0°C and +35°C.
- Ambient temperatures between 15°C and +25°C are ideal temperatures for your product.
- Do not let pets enter the product. Check inside the product before using.
- Do not overload the machine for drying. Observe the maximum load levels specified for drying.

Important instructions for safety and environment

PRECAUTION



- Do not dry leather laundry or laundry that contains leather (such as leather jeans label). The colour from Leather parts can run into other textiles.
- In failures that cannot be repaired using information given in safety instructions, turn off the machine, unplug the power cable and call the Authorised Service Agent.
- You can just wash laundry, just dry laundry or wash and dry laundry in your washer-dryer. Machine must not be used only to dry wet loads for a long time. When machine is used only for drying, it must be operated empty without loading laundry in a short wash programme after every 15 operation.
- Check all clothes before loading them into the machine and ensure that they do not have objects such as lighters, coins, metal pieces, needles in the pockets or inside.
- Underwear with metal supports must not be dried in the machine. Metal supports might come off during drying and cause damage in the machine. Place in a bag or pillowcase.
- Do not dry large laundry such as tulle curtain, curtain, bedding, blanket, rug in the machine. Your laundry might get damaged.

INFORMATION



- *Do not dry unwashed laundry in the machine.*
- *Do not use fabric softeners or static preventers in the machine unless recommended by the manufacturer.*
- *Products such as fabric softeners must be used in accordance with manufacturer's instructions.*
- *Do not dry sensitive clothes such as silk, wool, etc. in the machine. Otherwise, wool clothes may get shrunken and other sensitive clothes may get damaged.*
- *Check symbols on the garment tag before washing and drying.*

Important instructions for safety and environment

1.2 Intended use

INFORMATION



- *This product has been designed for domestic use. It is not suitable for commercial use and it must not be used out of its intended use.*
- *The product must only be used for washing, rinsing and drying of textile products that are marked accordingly.*
- *The manufacturer waives any responsibility arisen from incorrect usage or transportation.*
- *The service life of your product is 10 years. During this period, original spare parts will be available to operate the product properly.*

1.3 Children's safety

CAUTION



- **Children below the age of 3 must be kept away from the machine unless they are continuously supervised.**
- **Packaging materials are dangerous to children. Keep packaging materials in a safe place away from reach of the children.**
- **Electrical products are dangerous for the children. Keep children away from the product when it is in use. Do not allow them to play with the product. Use child lock to prevent children from intervening with the product.**
- **Do not forget to close the loading door when leaving the room where the product is located.**
- **Store all detergents and additives in a safe place away from the reach of the children by closing the cover of the detergent container or sealing the detergent package.**

Important instructions for safety and environment

1.4 Compliance with WEEE Directive and disposing of the waste product

- This product does not contain harmful and forbidden materials described in the "Regulation on the Control of the Waste Electrical and Electronic Equipment". It complies with the WEEE Directive.



This product has been manufactured with high quality parts and materials which can be reused and are suitable for recycling. Therefore, do not dispose the product with normal domestic waste at the end of its service life. Take it to a collection point for the recycling of electrical and electronic equipment. Please consult your local authorities to learn the nearest collection point. Help protect the environment and natural resources by recycling used products. For children's safety, cut the power cable and break the locking mechanism of the loading door so that it will be non-functional before disposing of the product.

Compliance with RoHS Directive:

The product you have purchased complies with EU RoHS Directive (2011/65/EU). It does not contain harmful and prohibited materials specified in the Directive.

1.5 Package information

Packaging materials of the product are manufactured from recyclable materials in accordance with our National Environment Regulations. Do not dispose of the packaging with normal domestic waste. Take them to the packaging material collection points designated by the local authorities.

2 Your washer-dryer



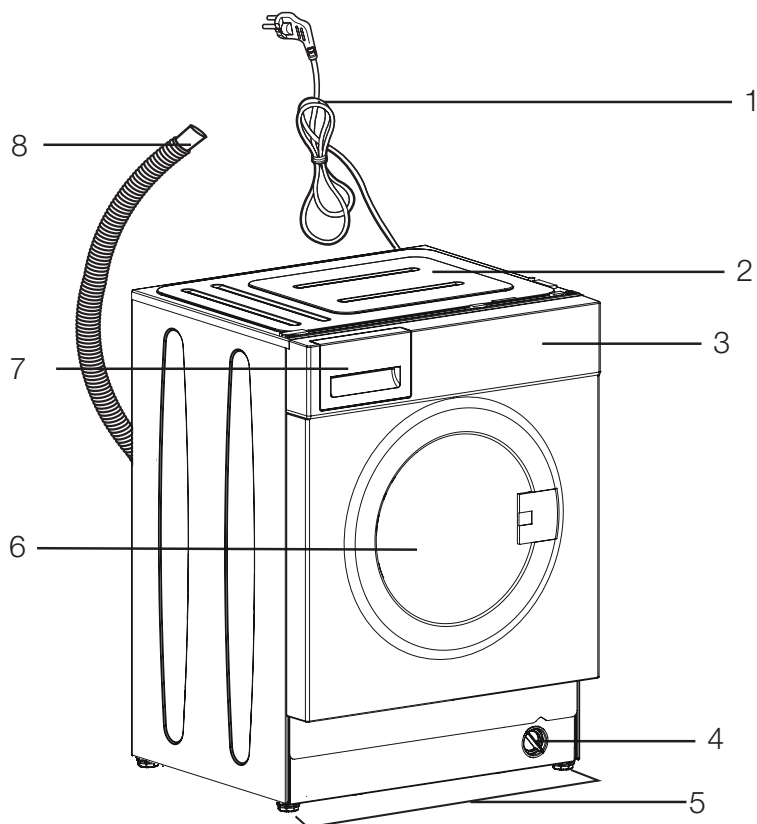









2.1 Overview

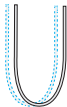
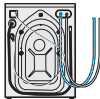

- 1- Power cable
- 2- Top panel
- 3- Control panel
- 4- Filter cover
- 5- Adjustable feet
- 6- Loading door
- 7- Detergent drawer
- 8- Water discharge hose

Your washer-dryer

2.2 Package contents

	Power cable		
	Water discharge hose		
	Transit bolts		
	Mains water inlet hose		
	User manual		
	Plastic plug group		



NOTE

- Figures in this manual are schematic and may not match the product exactly.

Your washer-dryer

2.3 Technical specifications

Complying Commission Delegated Regulation (EU) No.96/60/EC/1996

Supplier name or trademark	Beko
Model name	HITV 8733 B0
Washer Dryer Energy efficiency class ⁽¹⁾	A
Washing Energy efficiency class ⁽¹⁾	A
(Washing & Drying) Energy Consumption - full load per cycle (kWh)	5,44
Washing Energy Consumption - full load per cycle (kWh)	0,76
Annual (Washing & Drying) Energy Consumption (kWh) ⁽²⁾	1088
Annual Washing Energy Consumption (kWh) ⁽²⁾	172
Water Consumption (Washing & Drying) full load per cycle- (l)	78
Water Consumption (Washing) full load per cycle (l)	47
Annual Water Consumption (Washing & Drying)- (l) ⁽³⁾	15600
Annual Water Consumption (Washing) (l) ⁽³⁾	9400
Spin-drying efficiency class (1)	A
Maximum spin speed (rpm)	1400
Airborne acoustical noise emissions washing/spinning/drying (dB)	47/73/58
Built-in	Yes
Rated capacity - Washing (kg)	8
Rated capacity - Drying (kg)	5
Height (cm)	82
Width (cm)	60
Depth (cm)	55
Net weight (±4 kg.)	68
Single Water inlet / Double Water inlet	• / -
• Available	
Electrical input (V/Hz)	230 V / 50Hz
Total current (A)	10
Total power (W)	2200
VDE Main model code	9620
⁽¹⁾ Scale from A (Highest Efficiency) to G (Lowest Efficiency)	

⁽²⁾ Energy Consumption based on 200 standard washing cycles - full loads washing (and drying). Actual energy consumption will depend on how the appliance is used.

⁽³⁾ Water consumption based on 200 standard washing cycles - full loads washing (and drying). Actual energy consumption will depend on how the appliance is used.

Technical specifications may be changed without prior notice to improve the quality of the product.

3 Installation

To make the product ready for use, review the information in the user manual and make sure that the electricity, tap water supply and water drainage systems are appropriate before calling the Authorised Service Agent. If they are not, call a qualified technician and plumber to have any necessary arrangements carried out.

DANGER!



Make sure that the installation and electrical connections of the product are performed by competent persons. Manufacturer shall not be held liable for damages that may arise from procedures carried out by unauthorised persons.

DANGER!



Your product is too heavy for one person to carry.

CAUTION



- **Prior to installation, visually check if the product has any defects on it. If so, do not have it installed. Damaged products cause risks for your safety.**

PRECAUTION



- Preparation of the location and electrical, tap water and waste water installations at the place of installation is under customer's responsibility.
- Make sure that the water inlet and discharge hoses as well as the power cable are not folded, pinched or crushed while pushing the product into its place after installation or cleaning procedures.

3.1 Appropriate installation location

- Place the product on a solid and level floor. Do not place it onto a carpet with high pile or other similar surfaces.
- Do not place the product close to the edge if the floor contains steps. Do not also place the product on a platform.
- Do not place the product on the power cable.
- Do not install the product in environments where the temperature falls below 0 °C.(See. Warnings for Drying)
- Place the product at least 1,5 cm away from the edges of other furniture.

In the area where this product is installed, there must not be a lockable, sliding or hinged door that will restrict the full opening of loading door.

Installation

Operate the product in a well ventilated and dust free environment.

3.2 Removing packaging reinforcement



Tilt the machine backwards to remove the packaging reinforcement. Remove the packaging reinforcement attached to the ribbon.

DANGER!



Your product is heavy. Remove packaging reinforcement as displayed in the figure.

Be careful not to get your hand caught under the machine during this procedure.

3.3 Removing the transit bolts

PRECAUTION



- Do not remove the transit bolts before removing the packaging reinforcement.
- Remove the transit bolts before operating the washing machine! Otherwise, the product will get damaged.

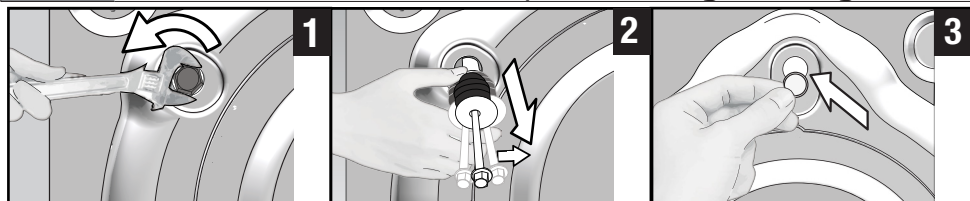

1 Use a tool to loosen all bolts until they rotate freely.

2 Remove the transit bolts by turning them slightly.

3 Attach the plastic covers supplied in the user manual bag into the holes on the rear panel.

Installation

INFORMATION



- *Keep the transit bolts in a safe place to reuse when the product needs to be moved again in the future.*
- *Never move the product without the transit bolts properly fixed in place!*

3.4 Connecting water supply

INFORMATION



- *The water supply pressure required to run the product is between 1 to 10 bars (0.1 - 1 MPa). It is necessary to have 10 - 80 liters of water flowing from the fully open tap in one minute to have your product run smoothly. Attach a pressure reducing valve if water pressure is higher.*

CAUTION



- **Models with a single water inlet should not be connected to the hot water tap. In such a case the laundry will get damaged or the product will switch to protection mode and will not operate.**
- **Do not use old or used water inlet hoses on the new product. It may cause stains on your laundry.**

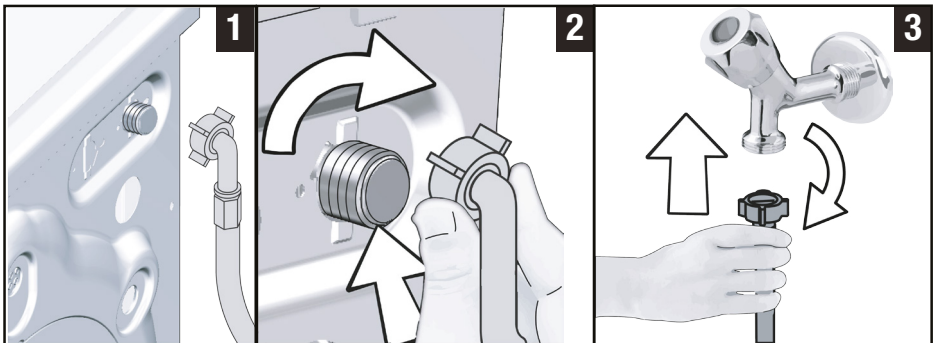

- 1 Connect the special hose supplied with the product to the water inlet on the product.

Installation

CAUTION



- **Ensure that the cold water connection is made correctly when installing the product. Otherwise, your laundry will come out hot at the end of the washing process and wear out.**

- 2 Tighten the hose nuts securely by hand. Never use a tool when tightening the nuts.
- 3 Open the taps completely after making the hose connection to check for water leaks at the connection points. If any leak occurs, turn off the tap and remove the nut. Retighten the nut carefully after checking the seal. In order to prevent the water leaks, keep the taps closed when you do not use the product.

3.5 Connecting to the drain

- Attach the end of the drain hose directly to waste water drain, sink or bathtub.

CAUTION



- **Your house will be flooded if the hose comes out of its housing during water discharge. Moreover, there is risk of scalding due to high washing temperatures! To prevent such situations and to ensure smooth water intake and discharge of the machine, fix the end of the discharge hose tightly so that it cannot displace.**

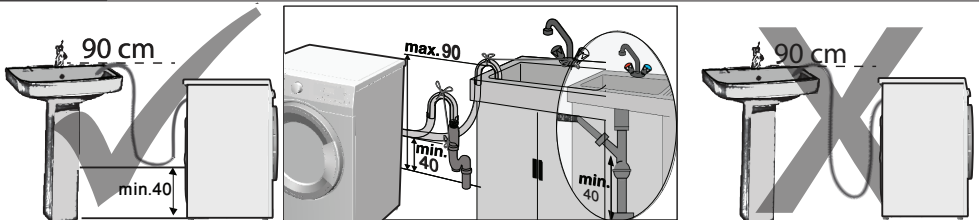

- Connect the hose to a minimum height of 40 cm and a maximum height of 90 cm.
- If the hose is run along the floor (or at less than 40 cm above it) and raised later on, water drain becomes difficult and laundry may come out extremely wet. Therefore, observe the heights described in the figure.
- To prevent flowing of dirty water back into the machine and to allow for easy discharge, do not immerse the hose end into the dirty water or do not drive it in the drain more than 15 cm. If it is too long, cut it short.
- The end of the hose should not be bent, it should not be stepped on and the hose must not be pinched between the drain and the machine.
- If the length of the hose is too short, add an original extension hose. Length of the hose may not be longer than 3.2 m. To avoid water leak failures, the connection

Installation

between the extension hose and the drain hose of the product must be fitted well with an appropriate clamp as not to come off and leak.

3.6 Adjusting the feet

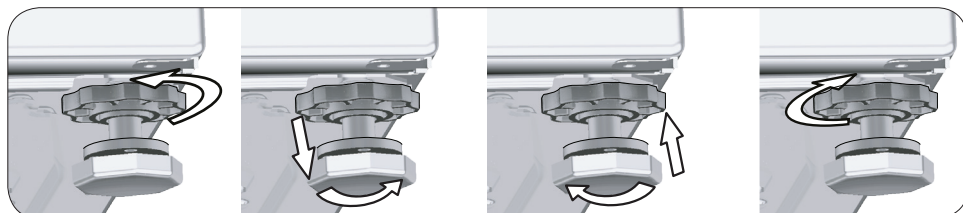

CAUTION



- **Adjust feet so that the product will be balanced in the location it will be used.**
- **Balance the machine by adjusting the feet.**
- **Check for any play by pressing the product from upper diagonal edges.**
- **Otherwise, the product may move from its place and cause crushing, noise and vibration problems.**
- **Do not use any tools to loosen the lock nuts. Otherwise, the lock nuts may get damaged.**

- a) Loosen the lock nuts on the feet by hand.
- b) Adjust the feet until the product stands level and balanced.
- c) Tighten all lock nuts again by hand.

3.7 Electrical connection

Connect the product to a grounded outlet protected by a 16 A fuse. Our company shall not be liable for any damages that will arise when the product is used without grounding in accordance with the local regulations.

- Connection must comply with national regulations.
- Power cable plug must be within easy reach after installation.
- If the current value of the fuse or breaker in the house is less than 16 Amps, have a qualified electrician install a 16 Amp fuse.
- The voltage specified in the "Technical specifications" section must be equal to your mains voltage.

Installation



DANGER!

Damaged power cables must be replaced by the Authorised Service Agent.

3.8 Transportation of the product

- 1 Unplug the product before transporting it.
- 2 Remove water drain and water supply connections.
- 3 Drain all water that has remained in the product. See 6.5
- 4 Install the transit bolts in reverse order of the disassembly procedure. See 3.3

DANGER!



Your product is too heavy for one person to carry. Your product is heavy; two persons must carry it and extra precaution taken on stairs. If your product falls on you, it may cause injuries.

CAUTION











































- Packaging materials are dangerous to children. Keep packaging materials in a safe place away from reach of the children.

INFORMATION



- *Never move the product without the transit bolts properly fixed in place!*

4 Preparation

LAUNDRY WASH SYMBOLS										
 WASH	Machine Wash Symbols									
	Water Temperatures	Maximum Symbol(s)	95°C 	70°C 	60°C 	50°C 	40°C 	30°C 		
 DRYING	Drying Symbols									
	Drying Settings									
 IRON	Iron -									
	Dry or Steam		Iron at high temperature	Iron at medium temperature	Iron at low temperature	Do not iron		Iron without steam		
	Maximum temperature		200 °C	150 °C	110 °C					
 BLEACH										
		All bleaches are allowed		Bleach (sodium hypochlorite) can be used		Bleach is not allowed		Only bleaches without chlorine are allowed		

Preparation

4.1 Sorting the laundry

- * Sort laundry according to type of fabric, colour, and degree of soiling and allowable water temperature.
- * Always observe the instructions given on the garment care labels.

4.2 Preparing laundry for washing

- Laundry items with metal attachments such as, underwired bras, belt buckles or metal buttons will damage the machine. Remove the metal pieces or wash such clothes by putting them in a cotton laundry bag or cotton pillow case. Also these type of clothes can heat too much during drying and damage your other clothes. Do not dry such laundry in the machine.
- Put small size clothes such as infant's socks and nylon stockings in cotton a laundry bag or cotton pillow case.
- Place curtains in without compressing them. Remove curtain attachment items. Do not dry tulle curtains in your machine.
- Fasten zips, sew loose buttons and mend rips and tears.
- Wash "machine washable" or "hand washable" labelled products only with an appropriate programme. Dry these type of clothes by hanging or laying down. Do not dry them in the machine.
- Do not wash colours and whites together. New, dark coloured cottons release a lot of dye. Wash them separately.
- Only use the dyes / colour changers and descaling agents which are appropriate to machine wash. Always follow the instructions on the package.

INFORMATION



- *Laundry that is subjected to heavy deposits of materials such as flour, lime dust, milk powder, etc. Must be shaken off before placing into the machine. Such dusts and powders on the laundry may build up on the inner parts of the product in time and can cause damage.*
- *Keep laundry items made of Angora wool in the freezer for a few hours before washing. This will reduce pilling.*
- *Wash trousers and delicate laundry turned inside out.*
- *Tough stains must be treated properly before washing. If unsure, check with a dry cleaner.*
- *Take out all substances in the pockets such as coins, pens and paper clips, and turn pockets inside out and brush. Such objects may damage the product or cause noise problem.*

Preparation

4.3 Tips for energy saving

Energy efficiency will be improved by using lower temperature programmes and appropriate detergents.

- Operate the product in the highest capacity allowed by the programme you have selected, but do not overload; see, "Programme and consumption table". See, "Programme and consumption table"
- Always follow the instructions on the detergent packaging.
- Wash slightly soiled laundry at low temperatures.
- Use faster programmes for small quantities of lightly soiled laundry.
- Do not use prewash and high temperatures for laundry that is not heavily soiled or stained.
- If you plan to dry your laundry in a dryer, select the highest spin speed recommended during washing process.
- Do not use more detergent than the recommended on the detergent packaging.

4.4 Initial use

Before starting to use the product make sure that all preparations are made in accordance with the "Important safety and environment instructions" and the instructions in the "Installation" section.

To prepare the product for washing laundry, perform first operation in Drum Cleaning programme. If this programme is not available in your machine, apply the method which is described in the section 6.2.



INFORMATION



- *Use an anti-limescale product suitable for the washing machines.*
- *Some water may remain in the product due to the quality control processes in the production. It is not harmful for the product.*

Preparation

4.5 Correct load capacity

The maximum load capacity depends on the type of laundry, the degree of soiling and the desired washing programme.

The product automatically adjusts the water amount according to the weight of the laundry put inside it.

CAUTION



- Follow the information in the “Programme and consumption table”. When overloaded, machine’s washing performance will drop. Moreover, noise and vibration problems may occur. For a successful drying performance, do not dry more laundry than stated.

Laundry type	Weight (g)	Laundry type	Weight (g)
Bathrobe	1200	Hand towel	100
Fabric napkin	100	Women’s night gown	200
Bed sheet	700	Underclothing	100
Bed sheet	500	Men’s overalls	600
Pillowcase	200	Men’s shirt	200
Tablecloth	250	Men’s pyjamas	500
Towel	200	Blouses	100

4.6 Loading the laundry

1. Open the loading door.
2. Put the laundry items into the product in a loose manner.
3. Push the loading door to close until you hear a locking sound. Ensure that no items are caught in the door.

INFORMATION



- *The loading door is locked while a programme is running. The loading door is unlocked a while after the programme comes to an end. If the inside part of the machine is too hot at the end of the programme, loading door will not open until the temperature decreases.*

CAUTION



- If the laundry is misplaced, noise and vibration problems may occur in the machine.

Preparation

4.7 Using detergent and softener

INFORMATION



- *When using detergent, softener, starch, fabric dye, bleach and descaling agents; read the manufacturer's instructions written on the package and follow the dosages specified. Use a measuring cup if available.*

4.7.1 Detergent drawer

The detergent drawer is composed of four compartments:

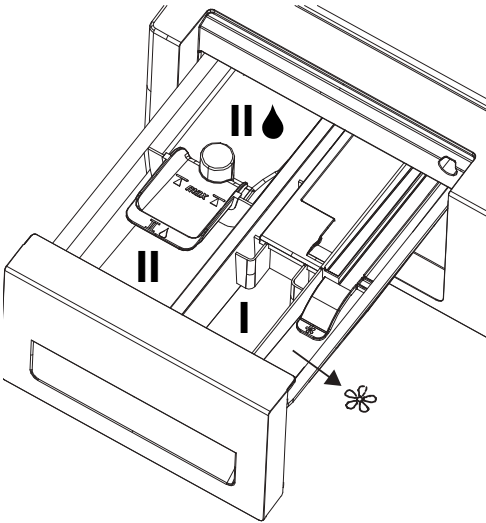

1) Left compartment with number "II" (Main wash compartment for powder detergent or powder bleach/stain remover)

2) Left compartment with number "II" and a water drop icon (Main wash compartment for liquid detergent or liquid stain remover)

3) Middle compartment with number "I" (pre-wash compartment for powder detergent, powder stain remover or liquid bleach - liquid bleach must be added either during the pre-wash or during the first rinsing step of the washing Programme). Liquid bleach must be added manually while the machine takes in water.

4) Right compartment with "⊗" symbol (liquid softener compartment) (⊗) in addition, there is a siphon piece in the softener compartment.

INFORMATION



- *Never leave the detergent drawer open while the washing programme is running!*
- *When using a programme without prewash, do not put any detergent into the prewash compartment (compartment nr. "I").*
- *Do not select a programme with prewash if you are using a detergent bag or dispensing ball. Place the detergent bag or the dispensing ball directly among the laundry in the machine. Remove these if drying*
- *When machine is in Drying step, do not add any washing chemicals (Liquid detergent, Softener, etc.).*

4.7.2 Main Wash Compartment

Before starting the washing Programme, put powder detergent into the left compartment with number "II". Powder bleach/stain remover must also be put into this compartment.

Put the liquid detergent into the main wash compartment with number "II"  before starting the washing Programme. Liquid stain remover must be put into this compartment.

Put the suggested amount of liquid detergent into the left compartment with "II"  symbol and dilute it to the maximum filling level line (max. II ) with warm water.

Particularly the concentrated detergents must be diluted with warm water; otherwise, the siphon may get clogged in time.

Do not fill the detergent above the maximum filling level line; otherwise the excess amount of detergent will reach the laundry without water and may cause stains on the garments. In this case you will need to refill the compartment. Do not pour the detergent onto the laundry directly since this may cause stains on the garments.

Preparation

4.7.3 Liquid Softener Compartment

Put the suggested amount of liquid softener into the right compartment with “❄” symbol and dilute it to the maximum filling level line (max. ❄) with warm water.

Particularly the concentrated softeners must be diluted with warm water; otherwise, the siphon may get clogged in time.

Do not fill the softener above the maximum filling level line; otherwise the excess amount of softener will get mixed with the washing water and you will need to refill the compartment. Do not pour the softener onto the laundry directly since this may cause stains on the garments.

Liquid softener will be dispensed automatically at the final rinsing step of the washing Programme.

4.7.4 Pre-Wash Compartment

Put the powder pre-wash detergent or powder stain remover into the middle compartment with number “1”.

You can also put liquid bleach into this compartment while the machine takes in water during pre-wash or first rinsing step. Adding the liquid bleach while the machine takes in water allows it to be diluted before it is poured onto the laundry.

You must select extra rinsing option if you use liquid bleach in a washing Programme. Bleach must be removed from the laundry with rinsing; otherwise it may cause itching on the skin.

INFORMATION



- *Read the dosage instructions and label of your garments carefully before using the liquid bleach.*

4.7.5 Choosing the detergent

Detergent type to be used depends on the fabric type and colour.

- Use different detergents for coloured and white laundry.
- Wash your delicate clothes only with special detergents (liquid detergent, wool shampoo, etc.) intended solely for delicate clothes.
- When washing dark coloured clothes and quilts, it is recommended to use liquid detergent.
- Wash woollens with special detergent made specifically for woollens.

CAUTION



- **Use only detergents manufactured specifically for washing machines.**
- **Do not use Powdered Soap.**

Preparation

4.7.6 Adjusting the amount of detergent

The amount of washing detergent to be used depends on the amount of laundry, the degree of soiling and water hardness.

- Do not use amounts exceeding the dosage quantities recommended on the detergent package to avoid problems of excessive foam, poor rinsing, financial savings and finally, environmental protection.
- Use lesser detergent for small amounts or lightly soiled clothes.

4.7.7 Using gel and tablet detergent

- If the gel detergent thickness is fluidal and your machine does not contain a special liquid detergent cup, put the gel detergent into the main wash detergent compartment during first water intake. If your machine contains a liquid detergent container, fill the detergent into this container before starting the programme.
- If the gel detergent thickness is not fluidal or in the shape of capsule liquid tablet, put it directly into the drum before washing.
- Put tablet detergents into the main wash compartment (compartment nr. "2") or directly into the drum before washing.

INFORMATION



- *Tablet detergents may leave residues in the detergent compartment. If you notice such residues, place the tablet detergent between the laundry, close to the lower part of the drum in future washings.*
- *Use the tablet or gel detergent without selecting the prewash function.*
- *Bear in mind that any plastic detergent cup, bowl etc in the drum should be removed before drying..*

Preparation

4.7.8 Using laundry starch

- Add liquid starch, powder starch or the dyestuff into the softener compartment.
- Do not use softener and starch together in a washing cycle.
- Wipe the inside of the machine with a damp and clean cloth after using starch.

4.7.9 Using bleaches

- Select a programme with prewash and add the bleach at the beginning of the prewash. Do not put detergent in the prewash compartment. As an alternative application, select a programme with extra rinse, add the bleach into an empty detergent drawer compartment and also add 1 glass of water from the same compartment when you see the rinsing step on the display for the first time.
- Do not use bleach and detergent by mixing them.
- Use just a little amount (approx. 50 ml) of bleaching agent and rinse the clothes very well as it causes skin irritation. Do not pour the bleach onto the laundry and do not use it with the coloured items.
- When using oxygen-based whitener, select a programme which washes the laundry at a low temperature.
- Oxygen-based whitener can be used with the detergent; however, if it is a different consistency, first put detergent in the compartment number "II" in the detergent dispenser and wait for the machine to flush the detergent when taking in water. While the product continues taking in water, add whitener in the same compartment.

4.7.10 Using limescale remover

- When required, use limescale removers manufactured specifically for washing machines only.

Preparation

4.8 Tips for efficient washing

		Clothes			
		Light Colours and Whites	Colours	Black/Dark Colours	Delicates/Woollens/Silks
		(Recommended temperature range based on soiling level: 40-90 °C)	(Recommended temperature range based on soiling level: cold -40 °C)	(Recommended temperature range based on soiling level: cold -40 °C)	(Recommended temperature range based on soiling level: cold -30 °C)
Soiling Level	Heavily Soiled (difficult stains such as grass, coffee, fruits and blood.)	It may be necessary to pre-treat the stains or perform prewash. Powder and liquid detergents recommended for whites can be used at dosages recommended for heavily soiled clothes. It is recommended to use powder detergents to clean clay and soil stains and the stains that are sensitive to bleaches.	Powder and liquid detergents recommended for colours can be used at dosages recommended for heavily soiled clothes. It is recommended to use powder detergents to clean clay and soil stains and the stains that are sensitive to bleaches. Detergents which do not contain bleach should be used.	Liquid detergents suitable for colours and dark colours can be used at dosages recommended for heavily soiled clothes.	Prefer liquid detergents produced for delicate clothes. Woollen and silk clothes must be washed with special woollen detergents.
	Normally Soiled (For example, stains caused by body on collars and cuffs)	Powder and liquid detergents recommended for whites can be used at dosages recommended for normally soiled clothes.	Powder and liquid detergents recommended for colours can be used at dosages recommended for normally soiled clothes. Detergents which do not contain bleach should be used.	Liquid detergents suitable for colours and dark colours can be used at dosages recommended for normally soiled clothes.	Prefer liquid detergents produced for delicate clothes. Woollen and silk clothes must be washed with special woollen detergents.
	Lightly Soiled (No visible stains exist.)	Powder and liquid detergents recommended for whites can be used at dosages recommended for lightly soiled clothes.	Powder and liquid detergents recommended for colours can be used at dosages recommended for lightly soiled clothes. Detergents which do not contain bleach should be used.	Liquid detergents suitable for colours and dark colours can be used at dosages recommended for lightly soiled clothes.	Prefer liquid detergents produced for delicate clothes. Woollen and silk clothes must be washed with special woollen detergents.

Preparation

4.9 Tips for correct drying

		Programmes				
		Cottons Drying	Synthetics Drying	Babyprotect +	Wash&Dry	Wash&Wear
Types of Clothes	Durable Clothes with Cotton-Content	Bed sheet, bedding, baby clothes, t-shirt, sweatshirt, durable knitted clothes, denim, canvas trousers, shirts, cotton socks, etc.	Not recommended!	It washes and dries consecutively! Bed sheet, bedding, baby clothes, t-shirt, sweatshirt, durable knitted clothes, denim, canvas trousers, shirts, cotton socks, etc.	It washes and dries consecutively! Bed sheet, bedding, baby clothes, t-shirt, sweatshirt, durable knitted clothes, denim, canvas trousers, shirts, cotton socks, etc.	Clothes which are worn for a short period of time an unstained, such as shirts, t-shirts, sweatshirts, etc. A very small amount of laundry should be loaded.
	Synthetics Clothes (Polyester, nylon, etc.)	Not recommended!	It is recommended for the polyester, nylon, polyacetate, acrylic-content clothes. Drying is not recommended for the viscose-content clothes. Drying explanations in the maintenance label should be taken into account.	It is recommended for the polyester, nylon, polyacetate, acrylic-content clothes at low temperatures with the washing and drying warnings given in the maintenance label taken into consideration.	It is recommended for the polyester, nylon, polyacetate, acrylic-content clothes at low temperatures with the washing and drying warnings given in the maintenance label taken into consideration.	Very slightly soiled and unstained shirts, t-shirts and synthetic content items. A very small amount of laundry should be loaded.
	Delicate (Silk, Woollens, Cashmere, Angora wool, etc. content) Clothes	Not recommended!	Not recommended!	Not recommended!	Not recommended!	Not recommended!
	Bulky laundry such as quilts, coats, curtains, etc.	Not recommended! It is not appropriate to dry bulky laundry inside the washing machine. Dry them by hanging or laying down.	Not recommended! It is not appropriate to dry bulky laundry inside the washing machine. Dry them by hanging or laying down.	Not recommended! It is not appropriate to dry bulky laundry inside the washing machine. Dry them by hanging or laying down.	Not recommended! It is not appropriate to dry bulky laundry inside the washing machine. Dry them by hanging or laying down.	Not recommended! It is not appropriate to dry bulky laundry inside the washing machine. Dry them by hanging or laying down.

5 Operating the product

5.1 Control panel

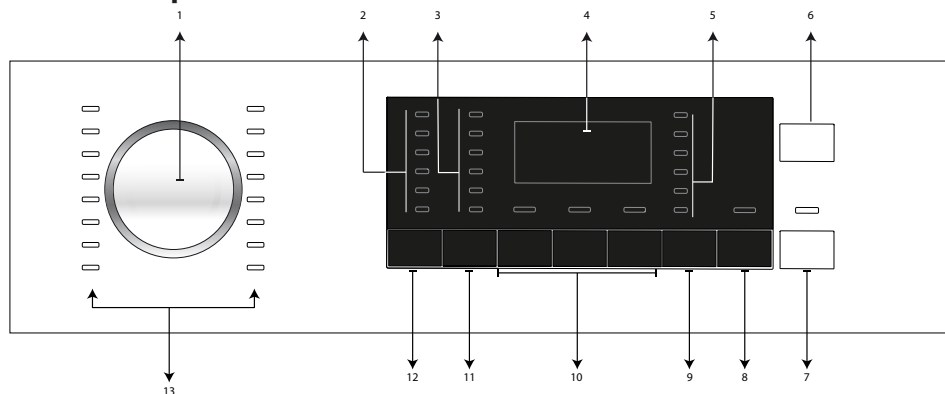

- 1 - Programme selection knob
- 2 - Temperature selection lights
- 3 - Spin speed selection lights
- 4 - Display
- 5 - Drying Programme Lights
- 6 - On / Off button
- 7 - Start / Pause button
- 8 - End Time Adjustment button
- 9 - Drying Level Adjustment button
- 10 - Auxiliary Function buttons
- 11 - Spin Speed Adjustment button
- 12 - Temperature Adjustment button
- 13 - Programme Selection lights

5.2 Display symbols

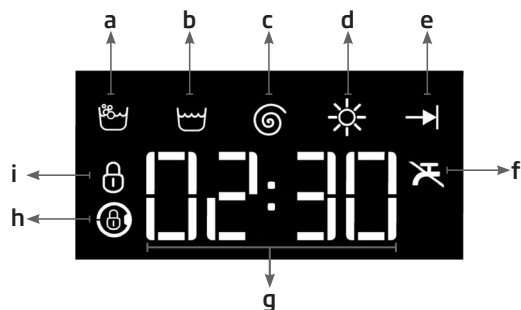

- a- Washing indicator
- b - Rinsing indicator
- c - Spinning indicator
- d- Drying indicator
- e- End indicator
- f- No Water indicator
- g - Duration Information display
- h- Loading Door Lock indicator
- i- Child Lock indicator

5.3 Preparing the machine

1. Check if the hoses are connected tightly.
2. Plug in your machine.
3. Turn the tap on completely.
4. Place the laundry in the machine.
5. Add detergent and fabric softener.

5.4 Selecting the washing programme

1. Determine the programme suitable for the type, quantity and soiling level of the laundry in accordance with the "Programme and consumption table".
2. Select the desired programme with the **Programme Selection** knob.

INFORMATION



- *Programmes are limited with the highest spin speed appropriate for that particular type of fabric.*
- *When selecting a programme, always consider the type of fabric, colour, soiling level and permissible water temperature.*
- *Always select the lowest appropriate temperature. Higher temperature means higher electricity consumption.*

5.5 Washing programmes

Depending on the type of fabric, use the following main programmes.

INFORMATION



- *You can set you machine to switch to drying step at the end of washing cycle by pressing the Drying button after you have selected the washing programme for your laundry. Each time you press the button, info line shows at which step the drying process will take place and the relevant symbol will turn on. If you want, by continuing to press the button, you can perform drying for the maximum period of time allowed by the machine for drying.*
- *Symbols in the display are schematic and may not match the product exactly.*
- *When you will perform washing and drying by using the Drying function of your machine, load maximum 5 kg of laundry into the machine. If you load excessively, your laundry will not dry and machine will operate for a long time and consume more energy.*

Operating the product

• Cottons

Use for your cotton laundry (such as bed sheets, duvet and pillowcase sets, towels, bathrobes, underwear, etc.). Your laundry will be washed with vigorous washing action for a longer washing cycle.

INFORMATION



- *You can dry your laundry after the washing cycle without any interruption (automatic or timed drying can be performed after washing). For this, you must also select the Drying function before starting the washing programme.*
- *According to the drying selections which you will add to the washing programmes, you can see when the programme will end on the display of the machine.*
- *If you don't want drying to take place after the programme you have selected, press and hold the Drying auxiliary function button until the Drying light is turned off.*

• Synthetics

Use to wash your synthetic clothes (shirts, blouses, synthetic/cotton blends, etc.). Your laundry will be washed with a gentle action for a shorter washing cycle when compared to the Cottons programme.

INFORMATION



- *You can dry your laundry after the washing cycle without any interruption (automatic or timed drying can be performed after washing). For this, you must also select the Drying function before starting the washing programme.*
- *According to the drying selections which you will add to the washing programmes, you can see when the programme will end on the display of the machine.*
- *If you don't want drying to take place after the programme you have selected, press and hold the Drying auxiliary function button until the Drying light is turned off.*

Operating the product

• Wool

Use to wash your woollen laundry. Select the appropriate temperature complying with the tag of your clothes. Use appropriate detergents for woollens.

INFORMATION



- *Drying function cannot be selected for the woollen wash programme.*

• Cottons Eco

Use to wash your normally soiled, durable cotton and linen laundry. Although it washes longer than all other programmes, it provides significant energy and water savings. Actual water temperature may be different from the stated washing temperature. When you load the machine with less laundry (e.g. ½ capacity or less), programme duration may automatically get shorter. In this case, energy and water consumption will decrease more, providing a more economic wash. This programme is available in the models with the remaining time indicator.

INFORMATION



- *You can dry your laundry after the washing cycle without any interruption (automatic or timed drying can be performed after washing). For this, you must also select the Drying function before starting the washing programme.*
- *According to the drying selections which you will add to the washing programmes, you can see when the programme will end on the display of the machine.*
- *If you don't want drying to take place after the programme you have selected, press and hold the Drying auxiliary function button until the Drying light is turned off.*

• Delicates

Use to wash your delicate laundry. Your laundry will be washed with more gentle washing action compared to the Synthetics programme.

• Hand Wash

Use to wash woollen/delicate laundry that bear "not machine-washable" care labels and for which hand wash is recommended. Your laundry will be washed with a very gentle washing action in order not to damage the clothes.

Operating the product

• Daily Xpress

Use to wash your lightly soiled and unstained cotton laundry in a short time.

INFORMATION



- *You can dry your laundry after the washing cycle without any interruption (automatic or timed drying can be performed after washing). For this, you must also select the Drying function before starting the washing programme.*
- *According to the drying selections which you will add to the washing programmes, you can see when the programme will end on the display of the machine.*
- *If you don't want drying to take place after the programme you have selected, press and hold the Drying auxiliary function button until the Drying light is turned off.*

• Xpress Super Short

Use it to wash a small amount of lightly soiled cotton laundry in a short time. This programme washes your laundry in 14 minutes.

INFORMATION



- *You can dry your laundry after the washing cycle without any interruption (automatic or timed drying can be performed after washing). For this, you must also select the Drying function before starting the washing programme.*
- *According to the drying selections which you will add to the washing programmes, you can see when the programme will end on the display of the machine.*
- *If you don't want drying to take place after the programme you have selected, press and hold the Drying auxiliary function button until the Drying light is turned off.*

Operating the product

• Shirts

Use to wash the shirts made of cotton, synthetic and synthetic blended fabrics together.

INFORMATION



- *You can dry your laundry after the washing cycle without any interruption (automatic or timed drying can be performed after washing). For this, you must also select the Drying function before starting the washing programme.*
- *According to the drying selections which you will add to the washing programmes, you can see when the programme will end on the display of the machine.*
- *If you don't want drying to take place after the programme you have selected, press and hold the Drying auxiliary function button until the Drying light is turned off.*

• Rinse

Use when you want to rinse or starch separately.

• Spin+Drain

Use to drain the water in the machine.

5.6 Temperature selection

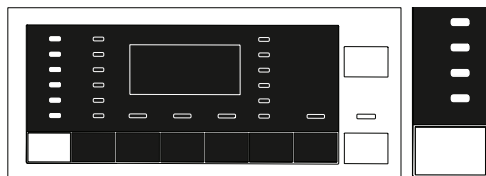

Whenever a new programme is selected, the recommended temperature for the programme appears on the temperature indicator. It is possible that the recommended temperature value is not the maximum temperature that can be selected for the current programme.

Press the **Temperature Adjustment** button to change the temperature.

INFORMATION



- *Temperature Adjustment button works only backwards. For example, when you want to select 60 °C when the display shows 40 °C you need to press the button for several times until you reach 60 °C by going backwards from 40 °C.*
- *If you scroll to Cold Wash option and press Temperature Adjustment button again, the recommended maximum temperature for the selected programme is displayed. Press the Temperature Adjustment button again to decrease the temperature.*

Finally, Cold light indicating the cold wash option appears on the display.

You can also change the temperature after the washing has started. You can select the desired temperature after washing starts but you must do this before heating step starts.

5.7 Spin speed selection

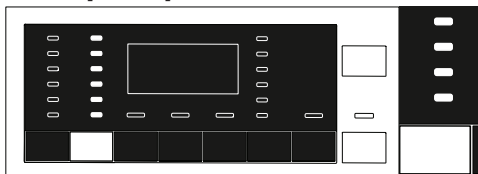

Whenever a new programme is selected, the spin speed recommended for the selected programme is displayed on the **Spin Speed** indicator.

INFORMATION



- *It is possible that the recommended spin speed value is not the maximum spin speed that can be selected for the current programme.*

Press the **Spin Speed Adjustment** button to change the spin speed. Spin speed decreases gradually.

Then, depending on the model of the product, "Rinse Hold" and "No Spin" options appear on the display.

INFORMATION



- *Spin Speed Adjustment button works only backwards. For example, when you want to select 1000 rpm when the display shows 800 rpm, you need to press the button for several times until you reach 1000 rpm by going backwards from 800 rpm.*
- *Rinse Hold option is indicated with "👤" symbol and No Spin option is indicated with "🌀" symbol.*

Operating the product

5.7.1 If you want to spin your laundry after the Rinse Hold function:

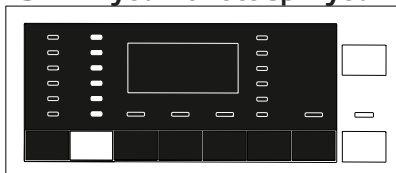

- Adjust the **Spin Speed**.

- Press **Start / Pause / Cancel** button. The programme resumes. Machine drains the water and spins the laundry.

If you want to drain the water at the end of the programme without spinning, use **No Spin** function.

INFORMATION



- *In programmes that do not allow spin speed adjustment, when Spin Speed adjustment button is pressed, spin speed light does not change and the buzzer is heard.*

You can also change the Spin Speed after the washing starts. You can select spin speed by pressing spin speed adjustment button after washing has started but before the spinning step.

5.7.2 Auxiliary function selection for drying

When a new programme is selected, press Auxiliary Function Selection button to adjust the drying option that is suitable for the selected washing programme.

INFORMATION



- *In programmes that do not allow drying adjustment, when Drying auxiliary function button is pressed drying light does not change and the buzzer is heard.*
- *Only for drying programmes, press Auxiliary Function Selection button to adjust the suitable drying option.*

5.8 Drying programmes

CAUTION



- Machine cleans the lint coming off the laundry automatically during the drying cycle. Machine uses water during drying. For this reason, water tap of the machine should be open also in the drying programmes.
- When a new programme is selected, press Auxiliary Function Selection button to adjust the drying option that is suitable for the selected washing programme.

INFORMATION



- *Drying programmes contain spinning step. Your machine performs this process in order to shorten the drying time. When drying is selected, spin speed setting is in Maximum spin speed range.*
- *In programmes that do not allow drying adjustment, when Drying auxiliary function button is pressed drying light does not change and the buzzer is heard.*
- *Only for drying programmes, press Auxiliary Function Selection button to adjust the suitable drying option.*
- *While there is a water cut, both washing and drying could not be performed.*

• Synthetic Dry

Use to dry damp synthetic laundry equivalent to 3 kg dry weight. This programme performs drying only.

INFORMATION



- *For the dry weights of the laundry, see Section 4, Step 4.5*

• Cotton Dry

Use to dry damp cotton laundry equivalent to 5 kg dry weight. This programme performs drying only.

INFORMATION



- *In order to dry the laundry which contains only towels and bathrobes, load 4 kg laundry maximum.*
- *For the dry weights of the laundry, see Section 4, Step 4.5*

5.9 Washing and drying programmes

CAUTION



- Machine cleans the lint coming off the laundry automatically during the drying cycle. Machine uses water during drying. For this reason, water tap of the machine should be open also in the drying programmes.

• 5 Kg Wash & Dry

Use to wash cotton laundry up to 5 kg and dry it right after the washing cycle without making any other selection.

INFORMATION



- *When this programme is selected, external Drying auxiliary function cannot be selected.*

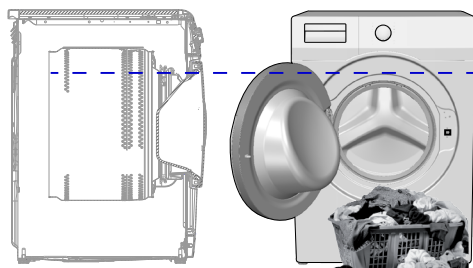

In 5 kg Wash & 5 kg Dry programme, it is recommended to load laundry until the level indicated in the above figure for ideal drying conditions (you will see the level arrow when you open the loading door).

• Wash & Wear

Use to wash and dry 0.5 kg laundry (2 shirts) in 40 minutes or 1 kg laundry (5 shirts) in 60 minutes.

INFORMATION



- *Wash&Wear programme is intended to quickly wash and dry the daily clothes which were worn for a short period of time and are not soiled. This programme is suitable for the laundry which contains thin-texture and can dry quickly. (shirts, t-shirts)*
- *Other drying options or programmes should be used for the thick texture laundry which take longer to dry.*

Operating the product

• BabyProtect+ Wash&Dry

Use to wash and then immediately dry your laundry up to 2 kg which requires an anti-allergic and hygienic washing (baby clothes, bed sheets, bedding, underpants, etc. cotton items).

INFORMATION



- *BabyProtect+ programme is tested and approved by "The British Allergy Foundation" (Allergy UK) in United Kingdom.*



Operating the product

5.10 Programme and consumption table

(for washing)

EN						Auxiliary functions				Selectable temperature range °C
Programme (°C)		Max. Load (kg)	Water Consumption (l)	Energy Consumption (kWh)	Max. Speed***	Prewash	Quicker Wash	Extra Rinse	Drying	
Cottons	90	8	78	2,40	1400	•	•	•	•	90-Cold
	60	8	78	1,50	1400	•	•	•	•	90-Cold
	40	8	78	1,00	1400	•	•	•	•	90-Cold
Cottons Eco	60**	8	47	0,76	1400				•	60-Cold
Synthetics	60	3	67	1,05	1200	•	•	•	•	60-Cold
	40	3	67	0,75	1200	•	•	•	•	60-Cold
Wool	40	1,5	45	0,45	1200			•		40-Cold
Delicates	40	3,5	48	0,50	1000	•				40-Cold
Hand Wash	30	1	35	0,30	1200					30-Cold
Xpress Super Short	30	2	32	0,10	1400			•	•	30-Cold
Daily Xpress	90	8	54	1,90	1400			•	•	90-Cold
	60	8	54	1,10	1400			•	•	90-Cold
	30	8	50	0,18	1400			•	•	90-Cold
Shirts	60	3,5	45	0,85	800	•	•	•	•	60-Cold

• : Selectable.

* : Automatically selected, no cancelling.

** : Energy Label programme (EN 50229)

***: If maximum spin speed of the machine is lower then this value, you can only select up to the maximum spin speed.

- : See the programme description for maximum load.



INFORMATION

- ****: If maximum spin speed of the machine is lower than this value, you can only select up to the maximum spin speed.*
- *The auxiliary functions in the table may vary according to the model of your machine.*
- *Water and power consumption may vary subject to the changes in water pressure, water hardness and temperature, ambient temperature, type and amount of laundry, selection of auxiliary functions and spin speed, and changes in mains voltage.*
- *You can see the washing duration on the display of your machine while selecting a programme. Depending on the amount of laundry you have loaded into your machine, there may be a difference of 1-1.5 hours between the duration shown on the display and the actual duration of the wash cycle. Duration will be automatically updated soon after the washing starts.*
- *“Selection patterns for auxiliary functions can be changed by the manufacturer. New selection patterns can be added or removed.”*
- *“The spin speed of your machine may vary according to the programme; this spin speed cannot exceed the max. spin speed of your machine.”*

Operating the product

Programme and consumption table (for drying)

EN						Auxiliary functions				Drying level				
Programme (°C)		Max. Load (kg)	Water Consumption (l)	Energy Consumption (kWh)	Max. Speed***	Prewash	Quicker Wash	Extra Rinse	Drying	Extra Dry	Cupboard Dry	Iron Dry	Time based drying - minutes	Selectable temperature range °C
Cotton Dry	-	5	35	2,75	1400				*	•	•	•	•	-
Synthetic Dry	-	3	22	1,70	-				*		•	•	•	-
BabyProtect+ Wash&Dry	60	2	120	3,80	1400			*	*	•	•	•	•	90-30
5kg Wash&Dry	60	5	94	5,00	1400				*	•	•	•	•	60-Cold
Wash&Wear	30	0,5	35	0,60	1000			•	*				•	30-Cold
Wash&Wear	30	1	44	1,00	1000			•	*				•	30-Cold



INFORMATION

Information for the testing organizations;

Information for the testing organizations;

Washing performance tests for EU energy labelling are performed in „Cottons Eco 60°C“ programme as per the EN 50229 standard.

According to the EN 50229 standard for EU energy labelling drying performance, the maximum washing load must be divided into groups as the maximum drying load and the remaining drying load, and then each load must be dried using the option „Cottons Drying Extra Dry“.

5.11 Auxiliary function selection

Select the desired auxiliary functions before starting the programme. Whenever a programme is selected, lights of the auxiliary functions that can be selected together with that programme illuminate.

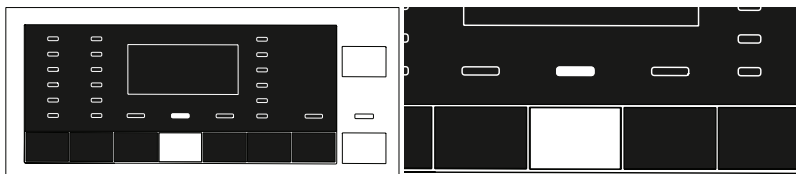

INFORMATION



- *Light of the auxiliary function that cannot be selected with the selected programme does not illuminate. When you press the buttons of these auxiliary functions, buzzer is heard and selection is prohibited.*

If the wash cycle has reached a point where you cannot select the auxiliary function, the function cannot be selected.

INFORMATION



- *Some functions cannot be selected together. If a second auxiliary function conflicting with the first one is selected before starting the machine, the function selected first will be cancelled and the second auxiliary function selection will remain active. For example, if you want to select Quick Wash after you have selected the Prewash, Prewash will be cancelled and Quick Wash will remain active.*
- *An auxiliary function that is not compatible with the programme cannot be selected. (See "Programme and consumption table")*
- *Some programmes have auxiliary functions that must be operated with the selected programme. Those functions cannot be cancelled. Auxiliary function light is already selected.*

Operating the product

INFORMATION



- *If the selected dampness level (Iron Dry, Wardrobe Dry, Extra Wardrobe Dry) cannot be reached at the end of the drying cycle, your machine will extend the programme duration automatically. Programme will last longer.*
- *If Timed-Drying is selected, programme is finished at the end of the drying period even if the laundry does not get dry.*
- *If the selected dampness level (Iron Dry, Wardrobe Dry, Extra Wardrobe Dry) is reached during drying cycle, or extra dryness is detected in the timed-drying options, programme will take a shorter time. Time decrease will be shown on the display.*

• Prewash

A Prewash is only worthwhile for heavily soiled laundry. Not using the Prewash will save energy, water, detergent and time.

• Quicker Wash

This function can be used in Cottons and Synthetics programmes. It decreases the washing times and also the number of rinsing steps for lightly soiled laundry.

INFORMATION



- *When you select this function, load your machine with half of the maximum laundry specified in the programme table.*

• Extra Rinse

This function enables the product to make another rinse in addition to the one already made after the main wash. Thus, the risk for sensitive skins (babies, allergic skins, etc.) to be effected by the minimal detergent remnants on the laundry can be reduced.

INFORMATION



- *Pressing for the first time will add single rinse, a second press will add double rinse. The third press will cancel it.*

• Drying

This function enables drying of the laundry after washing. Check with which programmes this auxiliary function can be selected, from the programme table.

5.12 Drying steps

5.12.1 Iron Dry

Drying is performed until the drying level reaches Iron Dry step.

5.12.2 Cupboard Dry

Drying is performed until the drying level reaches Wardrobe Dry step.

5.12.3 Extra Dry

Drying is performed until the drying level reaches Extra Wardrobe Dry step.

INFORMATION



- *Dryness level may change according to the mixture, material types, amount and dampness level of the laundry.*
- *Items which contain accessories such as lace, tulle, stones, beads, spacer, wire, etc. and high silk-content items should not be dried in the machine.*

5.12.4 Time based drying-minutes

In order to reach the desired drying level at low temperature, you select any of 30, 90 and 150 minutes of drying periods.

Operating the product

INFORMATION



- *When drying small amount of laundry (up to maximum 2 pieces), timed-drying steps in the Cottons or Synthetics drying programmes should be selected.*
- *If the laundry is not at the desired dryness level at the end of the drying programme, timed-drying can be selected to finish the process.*
- *When this function is selected, machine performs drying for the adjusted time irrespective of the drying level.*

5.13 Time display

Remaining time for the completion of the programme while it is running is displayed as "01:30" in hours and minutes format.

INFORMATION



- *Programme time may differ from the values in section "Programme and consumption table" depending on the water pressure, water hardness and temperature, ambient temperature, amount and the type of laundry, auxiliary functions selected and the changes at the mains voltage.*

5.14 End Time

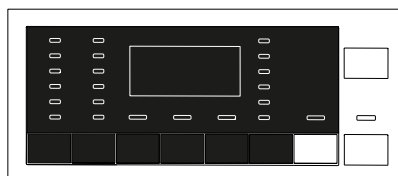

With the **End Time** function, the startup of the programme can be delayed up to 24 hours. After pressing **End Time** button, the programme's estimated ending time is displayed. If the **End Time** is adjusted, **End Time** light illuminates.

In order for the End Time function is activated and the programme is completed at the end of the specified time, you must press **Start / Pause** button after adjusting the time. **Start / Pause** button stops flashing and remains illuminated continuously.

If you want to cancel End Time function, press **End Time** button until the End Time light turns off or press **On / Off** button to turn off and on the machine.

1. Open the loading door, place the laundry and put detergent, etc.
2. Select the washing programme, temperature, spin speed and, if required, the auxiliary functions.

Operating the product

3. Set the end time of your choice by pressing the **End Time** button. **End Time** light is illuminated.
4. Press **Start / Pause** button. Time countdown starts. ":" symbol in the middle of the end time on the display starts flashing.

INFORMATION



- *Do not use liquid detergents when you activate End Time function! There is the risk of staining of the clothes.*
- *Door keeps locked during the End Time countdown period. In order to unlock the door, machine should be switched to the pause mode by pressing the programme start/pause button. At the end of the countdown, End Time indicator turns off, washing cycle starts and the time of the selected programme appears on the display.*
- *When the End Time selection is completed, the time appearing on the display consists of end time plus the duration of the selected programme.*

5.15 Starting the programme



1. Press **Start / Pause** button to start the programme.
2. The light of **Start / Pause** button which was flashing starts to illuminate steadily now, indicating that the programme has started.
3. Loading door is locked. "Locking the Door" appears on the display when the door is being locked.

5.16 Loading door lock



There is a locking system on the loading door of the machine that prevents opening of the loading door in cases when the water level is unsuitable for door opening. "Loading door locked" light in the panel turns on when the loading door is locked.

5.17 Changing the selections after programme has started

5.17.1 Adding laundry after the programme has started:



If the water level in the machine is suitable when you press **Start / Pause** button, "Loading door locked" light on the panel is turned off.

If the water level in the machine is not suitable when you press **Start / Pause** button, the panel will indicate that the loading door is locked.

5.17.2 Switching the machine to pause mode:

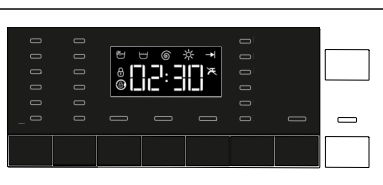

Press the **Start / Pause** button to switch the machine to pause mode.

5.17.3 Changing the programme selection after programme has started:

Changing the programme is not allowed when a programme is already running.

If you turn the **Programme Selection** knob while the programme is running, buzzer is heard and change is prohibited.

You can select the new programme after switching the current programme to pause mode.



INFORMATION

- *The newly selected programme starts from beginning.*

Operating the product

5.17.4 Changing the auxiliary function, spin speed and temperature

Depending on the step the programme has reached, you can cancel or select auxiliary functions. See, "Auxiliary function selection".

Also, you can change the spin speed, temperature and drying settings. See, "Spin speed selection" and "Temperature selection".

INFORMATION



- *The loading door will not open if the water temperature in the machine is high or the water level is above the loading door baseline.*

5.18 Child Lock

Use Child Lock function to prevent children from tampering with the machine. Thus you can avoid any changes in a running programme.

INFORMATION



- *You can switch the machine on and off with On / Off button when the Child Lock is active. When you switch on the machine again, programme will resume from where it has stopped.*
- *Machine will give an audio alarm when the buttons are pressed if the child lock is active.*

5.18.1 To activate the child lock:

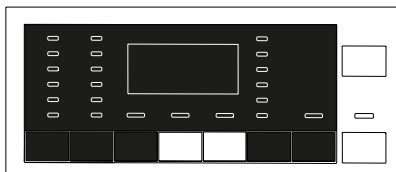

Press and hold 2nd and 3rd auxiliary function buttons for 3 seconds. After the countdown as "Child Lock 3-2-1" on the display is over, "Child Lock Enabled" appears on the display. You can release **2nd and 3rd Auxiliary Function** buttons when this warning is displayed.

Operating the product

5.18.2 To deactivate the child lock:

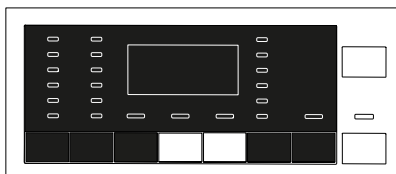

Press and hold 2nd and 3rd auxiliary function buttons for 3 seconds. After the countdown as "Child Lock 3-2-1" on the display is over, "Child Lock Enabled" is turned off on the display.

5.19 Cancelling the programme

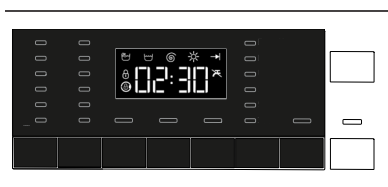

The programme is cancelled when the machine is turned off and on again. Press and hold **On / Off** button for 3 seconds. After the countdown as "3-2-1" on the display is over, the machine turns off.

INFORMATION



- *If you press On / Off button when the Child Lock is active, the programme will not be cancelled. You should cancel the child lock first. Countdown as "3-2-1" appears on the display.*
- *If you want to open the loading door after you have cancelled the programme but it is not possible to open the loading door since the water level in the machine is above the loading door baseline, then turn the Programme Selection knob to Pump+Spin programme and drain the water in the machine.*

5.20 End of programme

When the programme is over the End of Programme indicator illuminates and a buzzer is heard.

If you do not press any button for 2 minutes, the machine will switch to standby mode. Display and all indicators are turned off.

If you press any button or turn the **Programme Selection** knob when the machine is in standby mode, programme steps that are completed will appear on the display.

5.21 Your machine features a "Standby Mode".

After you switch on your machine with On-Off button, if no programme is started or no other procedure is performed at the selection step or no action is taken within approx. 2 minutes after the selected programme ends, your machine will switch to energy saving mode automatically. Also, if your product has a display that shows programme time, this display will be completely turned off. If you turn the Programme Selection knob or touch any button, lights and display will switch back to previous condition. The selections which you make when exiting from the energy efficiency may change. Please check the correctness of your selections before starting the programme. If necessary, please make your settings again. This is not an error.

6 Maintenance and cleaning

Service life of product extends and frequently experienced problems will be reduced if it is cleaned at regular intervals.

6.1 Cleaning the detergent drawer

Remove any powder residue buildup in the drawer. To do this;

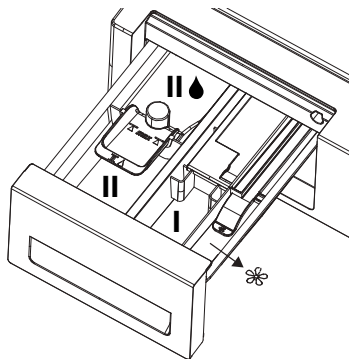

1. You can remove the detergent drawer by pulling it towards yourself strongly.

INFORMATION



- *If more than a normal amount of softener and liquid detergent mixture starts to remain in the softener compartment, the siphon must be cleaned.*

2. Wash the drawer and the siphon with plenty of lukewarm water in a washbasin. Wear protective gloves or use an appropriate brush to avoid touching the residues in the drawer when cleaning.

3. Replace the drawer into its housing after cleaning. Check if the siphon is in its original location.

6.2 Cleaning the loading door and the drum

For products with drum cleaning programme, please see Operating the product - Programmes.

For products without drum cleaning programme, follow the below steps to **clean the drum**:

Select **Additional Water** or **Extra Rinse** auxiliary functions. Use **Cottons programme** without pre-wash. Set **the temperature to the level recommended on the drum cleaning agent** which can be found in the detergent aisle in supermarkets. Apply this procedure **without any laundry in the product**. Before starting the programme, put 1 pouch of special drum cleaning agent (if the special agent could not be supplied, put max. 1 tea-cup of (max. 100 g) of antilimescale powder) into the main wash detergent compartment. If the antilimescale is in tablet form, put only one tablet into the main wash compartment no. "2". Dry the inside of the bellow with a clean piece of cloth after the programme has come to an end.

Maintenance and cleaning

INFORMATION



- Repeat Drum Cleaning process in every 2 months.
- Use an anti-limescale suitable for the washing machines.



After every washing and drying make sure that no foreign substance is left in the drum.

If the holes on the bellow shown in the figure are blocked, open the holes using a toothpick.

INFORMATION



- Foreign metal substances will cause rust stains in the drum. Clean the stains on the drum surface by using cleaning agents for stainless steel. Never use steel wool or wire wool.



CAUTION

- Never use sponge or scrub materials. These will damage the painted, chrome and plastic surfaces.

6.3 Cleaning the body and control panel

Wipe the body of the machine with soapy water or non-corrosive mild gel detergents as necessary, and dry with a soft cloth.

Use only a soft and damp cloth to clean the control panel.

6.4 Cleaning the water intake filters

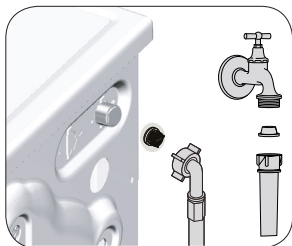

There is a filter at the end of each water intake valve at the rear of the machine and also at the end of each water intake hose where they are connected to the tap. These filters prevent foreign substances and dirt in the water to enter the washing machine. Filters should be cleaned if they are dirty.

Maintenance and cleaning

1. Close the taps.
2. Remove the nuts of the water intake hoses to access the filters on the water intake valves. Clean residues on them with an appropriate brush. If the filters are too dirty, remove them from their places with a pliers and clean in this way.
3. Take out the filters on the flat ends of the water intake hoses together with the gaskets and clean thoroughly under running water.
4. Replace the gaskets and filters carefully in their places and tighten the hose nuts by hand.

6.5 Draining remaining water and cleaning the pump filter

The filter system in your machine prevents solid items such as buttons, coins and fabric fibers clogging the pump impeller during discharge of washing water. Thus, the water will be discharged without any problem and the service life of the pump will extend.

If the machine fails to drain water, the pump filter is clogged. Filter must be cleaned whenever it is clogged or in every 3 months. Water must be drained off first to clean the pump filter.

In addition, prior to transporting the machine (e.g., when moving to another house) and in case of freezing of the water, water may have to be drained completely.

CAUTION



- **Foreign substances left in the pump filter may damage your product or may cause noise problem.**
- **If the product is not being used, shut the tap, remove mains hose and drain the water inside the machine in places where there is the risk of the product freezing .**
- **After each use, turn off the water tap to which the mains hose is connected.**

In order to clean the dirty filter and discharge the water:

1. Unplug the machine to cut off the supply power.

CAUTION



- **Temperature of the water inside the machine may rise up to 90 °C. To avoid burning risk, filter must be cleaned after the water in the machine cools down.**

Maintenance and cleaning

2. Some of our products have emergency draining hose and some does not have. Follow the steps below to discharge the water.

Discharging the water when the product does not have an emergency draining hose:

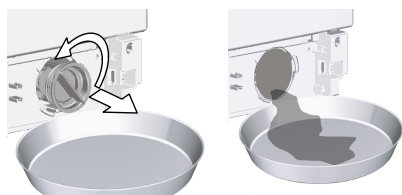

- a. Place a large container in front of the filter to catch water from the filter.
 - b. Loosen pump filter (anticlockwise) until water starts to flow. Fill the flowing water into the container you have placed in front of the filter. Always keep a piece of cloth handy to absorb any spilled water.
 - c. When the water inside the machine is finished, take out the filter completely by turning it.
3. Clean any residues inside the filter as well as fibers, if any, around the pump impeller region.
 4. Install the filter.
 5. If the filter cap is composed of two pieces, close the filter cap by pressing on the tab. If it is one piece, seat the tabs in the lower part into their places first, and then press the upper part to close.

7 Troubleshooting

Programmes do not start after the loading door is closed.

Start / Pause / Cancel button is not pressed. >>> **Press Start/Pause/Cancel button.*

Programme cannot be started or selected.

- Washing machine has switched to self protection mode due to a supply problem (line voltage, water pressure, etc. >>> *Press and hold On/Off button for 3 seconds to reset the machine to factory settings. (See. "Cancelling the programme")*

Water in the machine.

- Some water may remain in the product due to the quality control processes in the production. >>> *This is not a failure; water is not harmful to the machine.*

There is water leaking from the bottom of the machine.

- There is a problem with hoses or the pump filter. >>> *Be sure the seals of the water inlet hoses are securely fitted. Attach the hose to the tap tightly.*
- Pump filter is not closed securely. >>> *Make sure that the pump filter is closed securely.*

Machine does not fill with water.

- Tap is turned off. >>> *Turn on the taps.*
- Water inlet hose is bent. >>> *Flatten the hose.*
- Water inlet filter is clogged. >>> *Clean the filter.*
- Loading door is not closed. >>> *Close the loading door.*

Machine does not drain water.

- Water drain hose is clogged or twisted. >>> *Clean or flatten the hose.*
- Pump filter is clogged. >>> *Clean the pump filter.*

Machine vibrates or makes noise.

- Machine is standing unbalanced. >>> *Adjust the feet to level the machine.*
- A hard substance has entered into the pump filter. >>> *Clean the pump filter.*
- Transit bolts are not removed. >>> *Remove the transit bolts.*
- Laundry quantity in the machine is too little. >>> *Add more laundry to the machine.*
- Machine is overloaded with laundry. >>> *Take out some of the laundry from the machine or distribute the load by hand to balance it.*
- Machine is in contact with a rigid surface. >>> *Make sure that the machine is not contacting anything.*

Machine stopped shortly after the programme started.

- Machine has stopped temporarily due to low voltage. >>> *It will resume running when the voltage restores to the normal level.*

Machine directly discharges the water it takes in.

- Draining hose is not at adequate height. >>> *Connect the water draining hose as described in the user manual.*

No water can be seen in the machine during washing.

- The water level is not visible from outside of the washing machine. This is not a failure.

Troubleshooting

Loading door cannot be opened.

- Loading door lock is activated because of the water level in the machine. >>> *Drain the water by running the Pump or Spin programme.*
- Machine is heating up the water or it is at the spinning cycle. >>> *Wait until the programme completes.*
- Loading door lock is engaged. Loading door lock will be deactivated a couple of minutes after the programme comes to an end. >>> *Wait for a couple of minutes for deactivation of the loading door lock.*

Washing takes longer than specified in the user manual.(*)

- Water pressure is low. >>> *Machine waits until taking in adequate amount of water to prevent poor washing quality due to the decreased amount of water. Therefore, the washing time extends.*
- Voltage is low. >>> *Washing time is prolonged to avoid poor washing results when the supply voltage is low.*
- Input temperature of water is low. >>> *Required time to heat up the water extends in cold seasons. Also, washing time can be lengthened to avoid poor washing results.*
- Number of rinses and/or amount of rinse water have increased. >>> *Machine increases the amount of rinse water when good rinsing is needed and adds an extra rinsing step if necessary.*
- Excessive foam has occurred and automatic foam absorption system has been activated due to too much detergent usage. >>> *Use recommended amount of detergent.*

Programme time does not countdown. (On models with display) (*)

- Timer may stop during water intake. >>> *Timer indicator will not countdown until the machine takes in adequate amount of water. The machine will wait until there is sufficient amount of water to avoid poor washing results due to lack of water. Timer indicator will resume countdown after this.*
- Timer may stop during heating step. >>> *Timer indicator will not countdown until the machine reaches the selected temperature.*
- Timer may stop during spinning step. >>> *Automatic unbalanced load detection system might be activated due to the unbalanced distribution of the laundry in the drum.*

Programme time does not countdown. (*)

- Laundry is unbalanced in the machine. >>> *Automatic unbalanced load detection system might be activated due to the unbalanced distribution of the laundry in the drum.*

Machine does not switch to spinning step. (*)

- Laundry is unbalanced in the machine. >>> *Automatic unbalanced load detection system might be activated due to the unbalanced distribution of the laundry in the drum.*
- The machine will not spin if water is not drained completely. >>> *Check the filter and the draining hose.*
- Excessive foam has occurred and automatic foam absorption system has been activated due to too much detergent usage. >>> *Use recommended amount of detergent.*

Troubleshooting

Washing performance is poor: Laundry turns grey. (**)

- Insufficient amount of detergent has been used over a long period of time. >>> *Use the recommended amount of detergent appropriate for water hardness and the laundry.*
- Washing has been performed at low temperatures for a long time. >>> *Select the proper temperature for the laundry to be washed.*
- Insufficient amount of detergent is used with hard water. >>> *Using insufficient amount of detergent with hard water causes the soil to accumulate on the clothes over time and turns them grey. It is difficult to eliminate greying once it happens. Use the recommended amount of detergent appropriate for water hardness and the laundry.*
- Excessive amount of detergent has been used. >>> *Use the recommended amount of detergent appropriate for water hardness and the laundry.*

Washing performance is poor: Stains persist or the laundry is not whitened. (**)

- Insufficient amount of detergent is used. >>> *Use recommended amount of detergent appropriate for the laundry.*
- Excessive laundry is loaded in. >>> *Do not load the machine in excess. Load with amounts recommended in the "Programme and consumption table".*
- Wrong programme and temperature were selected. >>> *Select the proper programme and temperature for the laundry to be washed.*
- Wrong type of detergent is used. >>> *Use original detergent appropriate for the machine.*
- Detergent is put in the wrong compartment. >>> *Put the detergent in the correct compartment. Do not mix the bleaching agent and the detergent with each other.*

Washing performance is poor: Oily stains appeared on the laundry. (**)

- Regular drum cleaning is not applied. >>> *Clean the drum regularly. For this, please see 6.2.*

Washing performance is poor: Clothes smell unpleasantly. (**)

- Odours and bacteria layers are formed on the drum as a result of continuous washing at lower temperatures and/or in short programmes. >>> *Leave the detergent drawer as well as the loading door of the machine ajar after each washing. Thus, a humid environment favorable for bacteria cannot occur in the machine.*

Colour of the clothes faded. (**)

- Excessive laundry was loaded in. >>> *Do not load the machine in excess.*
- Detergent in use is damp. >>> *Keep detergents closed in an environment free of humidity and do not expose them to excessive temperatures.*
- A higher temperature is selected. >>> *Select the proper programme and temperature according to the type and soiling level of the laundry.*

Washing machine does not rinse well.

- The amount, brand and storage conditions of the detergent used are inappropriate. >>> *Use a detergent appropriate for the washing machine and your laundry. Keep detergents closed in an environment free of humidity and do not expose them to excessive temperatures.*
- Detergent is put in the wrong compartment. >>> *If detergent is put in the prewash compartment although prewash cycle is not selected, machine can take this detergent during rinsing or softener steps. Put the detergent in the correct compartment.*
- Pump filter is clogged. >>> *Check the filter.*
- Drain hose is folded. >>> *Check the drain hose.*

Troubleshooting

Laundry became stiff after washing. (**)

- Insufficient amount of detergent is used. >>> *Using insufficient amount of detergent for the water hardness can cause the laundry to become stiff in time. Use appropriate amount of detergent according to the water hardness.*
- Detergent is put in the wrong compartment. >>> *If detergent is put in the prewash compartment although prewash cycle is not selected, machine can take this detergent during rinsing or softener steps. Put the detergent in the correct compartment.*
- Detergent was mixed with the softener. >>> *Do not mix the softener with detergent. Wash and clean the drawer with hot water.*

Laundry does not smell like the softener. (**)

- Detergent is put in the wrong compartment. >>> *If detergent is put in the prewash compartment although prewash cycle is not selected, machine can take this detergent during rinsing or softener steps. Wash and clean the drawer with hot water. Put the detergent in the correct compartment.*
- Detergent was mixed with the softener. >>> *Do not mix the softener with detergent. Wash and clean the drawer with hot water.*

Detergent residue in the detergent drawer. (**)

- Detergent was put in wet drawer. >>> *Dry the detergent drawer before putting in detergent.*
- Detergent has gotten damp. >>> *Keep detergents closed in an environment free of humidity and do not expose them to excessive temperatures.*
- Water pressure is low. >>> *Check the water pressure.*
- The detergent in the main wash compartment got wet while taking in the prewash water. Holes of the detergent compartment are blocked. >>> *Check the holes and clean if they are clogged.*
- There is a problem with the detergent drawer valves. >>> *Call the Authorised Service Agent.*
- Detergent was mixed with the softener. >>> *Do not mix the softener with detergent. Wash and clean the drawer with hot water.*

There is detergent left on the laundry. (**)

- Excessive laundry was loaded in. >>> *Do not load the machine in excess.*
- Wrong programme and temperature were selected. >>> *Select the proper programme and temperature for the laundry to be washed.*
- Wrong detergent was used. >>> *Select the proper detergent for the laundry to be washed.*

Too much foam forms in the machine. (**)

- Improper detergents for the washing machine is used. >>> *Use detergents appropriate for the washing machine.*
- Excessive amount of detergent is used. >>> *Use only sufficient amount of detergent.*
- Detergent was stored under improper conditions. >>> *Store detergent in a closed and dry location. Do not store in excessively hot places.*
- Some meshed laundry such as tulle may foam too much because of their texture. >>> *Use smaller amounts of detergent for this type of item.*
- Detergent was put in the wrong compartment. >>> *Put the detergent in the correct compartment.*
- Softener is being taken early. >>> *There may be problem in the valves or in the detergent drawer. Call the Authorised Service Agent.*

Troubleshooting

Foam is overflowing from the detergent drawer.

- Excessive amount of detergent is used. >>> *Mix 1 tablespoonful softener and ½ L water and pour into the main wash compartment of the detergent drawer.*
- Put detergent into the machine suitable for the programmes and maximum loads indicated in the "Programme and consumption table". When you use additional chemicals (stain removers, bleaches and etc), reduce the amount of detergent.

Laundry remains wet at the end of the programme. (*)

- Excessive foam has occurred and automatic foam absorption system has been activated due to too much detergent usage. >>> *Use recommended amount of detergent.*

Drying lasts too long.

- Excessive laundry loaded. >>> *Do not load the machine in excess.*
- Laundry is not spun enough. >>> *Spin at a higher spin speed in washing step in the Dryer-Washing Machine.*
- Tap is turned off. >>> *Turn on the taps.*

Laundry is still damp after drying.

- An appropriate programme according to laundry type might is not selected. >>> *Check care labels on clothes and select an appropriate programme or use timed programmes in addition.*
- Excessive laundry loaded. >>> *Do not load the machine in excess.*
- Laundry is not spun enough. >>> *Spin at a higher spin speed in washing step in the Dryer-Washing Machine.*

Machine does not start or programme cannot be started.

- Power cable is not connected. >>> *Make sure the power cable is connected.*
- Programme is not set or Start / Pause / Cancel button is not pressed. >>> *Make sure the programme is set and it is not in Stand-by mode.*
- Child lock enabled. >>> *Disable Child lock.*

Laundry is shrunken, pale, matted or damaged.

- An appropriate programme according to laundry type is not selected. >>> *Check care labels on clothes and select an appropriate programme or use timed programmes in addition. You must not dry clothes that are not suitable for drying.*

Machine does not dry.

- Laundry is not dried or drying step is not enabled. >>> *Check if drying function is selected after the selected washing programme.*

Loading door cannot be opened.

Your machine's door is not opened for safety reasons. >>> *If door locked indicator is still active on display after drying, machine keeps the loading door locked until it cools for your safety.*

(*) Machine does not switch to spinning step when the laundry is not evenly distributed in the drum to prevent any damage to the machine and to its surrounding environment. Laundry should be rearranged and re-spun.

(**) Regular drum cleaning is not applied. >>> *Clean the drum regularly. See 6.2*



CAUTION

If you cannot eliminate the problem although you follow the instructions in this section, consult your dealer or the Authorised Service Agent. Never try to repair a nonfunctional product yourself.



www.beko.com