

beko

Dryer

User Manual

Szárító

Használati útmutató

Uscător

Manual de utilizare



DF 7412 PA



EN / HU / RO

2960312688_EN/090720.1250

Please read this user manual first!

Dear Customer,
Thank you for preferring a Beko product. We hope that your product which has been manufactured with high quality and technology will give you the best results. We advise you to read through this manual and the other accompanying documentation carefully before using your product and keep it for future reference. If you transfer the product to someone else, give its manual as well. Pay attention to all details and warnings specified in the user manual and follow the instructions given therein.
Use this user manual for the model indicated on the cover page.



- Read the instructions.

Explanation of symbols

Throughout this user manual the following symbols are used:



DANGER!

- Warning against electric shock.



DANGER!

- Warning against fire hazard.



WARNING!

- Warning for hazardous situations with regard to life and property.



WARNING!

- Warning against hot surfaces.



WARNING!

- Warning against scalding hazard.



NOTE

- Important information or useful hints about usage.



Packaging materials of the product are manufactured from recyclable materials in accordance with our National Environment Regulations.

Do not dispose of the packaging wastes with the domestic waste or other wastes, discard them to the dedicated collection points designated by the local authorities.



This product was manufactured using the latest technology in environmentally friendly conditions.

1 Important instructions for safety and environment



NOTE

- This section contains safety instructions that will help protect from risk of personal injury or property damage. Failure to follow these instructions shall void any warranty.

1.1 General safety



WARNING!

This appliance can be used by children aged from 8 years and above and persons with reduced physical, sensory or mental capabilities or lack of experience and knowledge if they have been given supervision or instruction concerning use of the appliance in a safe way and understand the hazards involved. Children shall not play with the appliance. Cleaning and user maintenance shall not be made by children without supervision.

Children of less than 3 years should be kept away unless continuously supervised.

- Adjustable feet should not be removed. The gap between the dryer and the floor should not be reduced with materials such as carpet, wood and tape. This will cause problems with the dryer.



WARNING!

Always have the installation and repairing procedures carried out by the Authorized Service. Manufacturer shall not be held liable for damages that may arise from procedures carried out by unauthorized persons.

- Never wash the dryer by spraying or pouring water onto it! There is the risk of electric shock!

For the products with a steam function:



WARNING!

- Use only distilled water or water condensed in the water tank of the machine in steam programs. Do not use mains water or additives. When using condensed water in the water tank, it should be filtered and cleared of fibres.
- Do not open the door when steam programs are running. Hot water may be expelled.
- Before putting laundry in a steam program, stains on it should be removed.
- You may only put laundry that is not dirty or stained but permeated with unpleasant odour in steam (odour removal) program.
- Do not use any dry cleaning sets or additional materials in a steam program or in any program.

1.1.1 Electrical safety



DANGER!

- Electrical safety instructions should be followed while electrical connection is made during the installation.
- Connect the dryer to a grounded outlet protected by a fuse at the value specified on the type label. Have the grounding installation performed by a qualified electrician. Our company shall not be liable for any damages that will arise when the dryer is used without grounding in accordance with the local regulations.
- The voltage and allowed fuse protection is stated on the type label plate.
- The voltage specified on the type label must be equal to your mains voltage.
- Unplug the dryer when it is not in use.
- Unplug the dryer from the mains during installation, maintenance, cleaning and repair works.
- Do not touch the plug with wet hands! Never unplug by pulling on the cable, always pull out by grabbing the plug.



WARNING!

- The appliance must not be supplied through an external switching device, such as a timer, or connected to a circuit that is regularly switched on and off by utility.



DANGER!

- Do not use extension cords, multi-plugs or adaptors to connect the dryer to power supply in order to decrease the risk of fire and electric shock.
- Power cable plug must be easily accessible after installation.
- Damaged mains cable should be changed notifying the Authorized Service.
- If the dryer is faulty, it must not be operated unless it is repaired by an authorized service agent! There is the risk of electric shock!

1.1.2 Product safety



DANGER!

- Superheating of the clothes inside of the dryer can occur if you cancel the programme or in the event of a power failure whilst the dryer is running, this concentration of heat can cause self-combustion and fire so always activate the ventilation programme to cool down or quickly remove all laundry from the dryer in order to hang them up and dissipate the heat.



WARNING!

- Ensure that the air inlet of the dryer is open and it is well-ventilated.
- Product contains R290 refrigerant.
- R290 is an environment-friendly, but flammable refrigerant.
- Keep the product away from potential heat sources that may cause it to ignite.

**DANGER!****Points to be taken into consideration for fire hazard:**

Below specified laundry or items must not be dried in the dryer considering fire hazard.

- Unwashed laundry items
- Items soiled with oil, acetone, alcohol, fuel oil, kerosene, stain removers, turpentine, paraffin, paraffin removers, petrol, wax or wax removers must be washed in hot water with plenty of detergent before being dried in the dryer.

For this reason especially the items containing the above specified stains must be washed very well, to do this use adequate detergent and choose a high washing temperature.

Below specified laundry or items must not be dried in the dryer due to the fire hazard:

- Garments or pillows bolstered with rubber foam (latex foam), shower bonnets, water resistant textiles, materials with rubber reinforcement and rubber foam pads.

Clothing cleaned with industrial chemicals.

Items such as lighter, match, coins, metal parts, needle etc. may damage the drum set or may lead to functional problems. Therefore check all the laundry that you will load into your dryer.

**WARNING!**

Never stop your dryer before the programme completes. If you must do this, remove all laundry quickly and lay them out to dissipate the heat.

**DANGER!**

- Clothes that are washed inadequately may ignite on their own and even may ignite after drying ends.
- You must provide enough ventilation in order to prevent gases exiting from devices operating with other types of fuels including the naked flame from accumulating in the room due to the back fire effect.

**WARNING!**

- Underwear that contains metal reinforcements should not be dried in the dryer. Dryer may be damaged if metal reinforcements come loose and break off during drying.

**NOTE**

- Use softeners and similar products in accordance with the instructions of their manufacturers.

Always clean the lint filter before or after each loading. Never operate the dryer without the lint filter installed.



WARNING!

- Never attempt to repair the dryer by yourself. Do not perform any repair or replacement procedures on the product even if you know or have the ability to perform the required procedure unless it is clearly suggested in the operating instructions or the published service manual. Otherwise, you will be putting your life and others' lives in danger.
- There must not be a lockable, sliding or hinged door that may block the opening of the loading door in the place where your dryer is to be installed.
- Install your dryer at places suitable for home use. (Bathroom, closed balcony, garage etc.)
- Make sure that pets do not enter the dryer. Check the inside of the dryer before operating it.
- Do not lean on the loading door of your dryer when it is open, otherwise it may fall over.
- The lint must not be allowed to accumulate around the tumble dryer
- The tumble dryer is not to be used if industrial chemicals have been used for cleaning.
- Fabric softeners, or similar products, should be used as specified by the fabric softener instructions.
- Exhaust air must not be discharged into a flue which is used for exhausting fumes from appliances burning gas or other fuels.

1.2 Mounting over a washing machine

- A fixing device should be used between the two machines when installing the dryer above a washing machine. The fitting device must be installed by the authorized service agent.
- Total weight of the washing machine and the dryer -with full load- when they are placed on top of each other reaches to approx. 180 kilograms. Place the products on a solid floor that has sufficient load carrying capacity!



WARNING!

- Washing machine cannot be placed on the dryer. Pay attention to the above warnings during the installation on your washing machine.

Installation Table for Washing Machine and Dryer

Dryer Depth	Washing Machine Depth			
	62 cm	60 cm	54 cm	< 50 cm
54 cm	Can be installed		Cannot be installed	
60 cm	Can be installed		Cannot be installed	

1.3 Intended use

- Dryer has been designed for domestic use. It is not suitable for commercial use and it must not be used out of its intended use.
- Use the dryer only for drying laundry that are marked accordingly.
- The manufacturer waives any responsibility arisen from incorrect usage or transportation.
- The service life of the dryer that you purchased is 10 years. During this period, original spare parts will be available to operate the dryer properly.

1.4 Child safety

- Packaging materials are dangerous for the children. Keep packaging materials away from children.
- Electrical products are dangerous for the children. Keep children away from the product when it is operating. Do not let

them tamper with the dryer. Use the child-proof lock in order to prevent the children to tamper with the dryer.



NOTE

Child-proof lock is on the control panel.
(See Child lock)

- Keep loading door closed even when the dryer is not in use.

1.5 Compliance with the WEEE regulation and disposing of the waste product



This product complies with EU WEEE Directive (2012/19/EU). This product bears a classification symbol for waste electrical and electronic equipment (WEEE).

This product has been manufactured with high quality parts and materials which can be reused and are suitable for recycling. Do not dispose of the waste product with normal domestic and other wastes at the end of its service life. Take it to the collection center for the recycling of electrical and electronic equipment. Please consult your local authorities to learn about these collection centers.



DANGER!

- R290 is a flammable refrigerant. Thus, ensure that the system and the pipes are not harmed during operation and handling.
- Keep the product away from potential heat sources that may cause it to ignite in case of damage.
- Do not dispose of the product by putting it in fire.

1.6 Compliance with RoHS Directive:

The product you have purchased complies with EU RoHS Directive (2011/65/EU). It does not contain harmful and prohibited materials specified in the Directive.

1.7 Package information

Packaging materials of the product are manufactured from recyclable materials in accordance with our National Environment Regulations. Do not dispose of the packaging materials together with the domestic or other wastes. Take them to the packaging material collection points designated by the local authorities.

1.8 Technical Specifications

EN

Height (Min. / Max.)	84,6 cm / 86,6 cm*
Width	59,7 cm
Depth	50,8 cm
Capacity (max.)	7 kg**
Net weight (± %10)	40 kg
Voltage	See type label***
Rated power input	
Model code	

* Min. height: Height with adjustable feet are closed.

Max. height: Height with adjustable feet are opened maximum.

** Dry laundry weight before washing.

*** Type label is located behind the loading door.



NOTE

- Technical specifications of the dryer are subject to specification without notice to improve the quality of the product.
- Figures in this manual are schematic and may not match the product exactly.
- Values stated on markers on the dryer or in the other published documentation accompanying with the dryer are obtained in laboratory in accordance with the relevant standards. Depending on operational and environmental conditions of the dryer, these values may vary.





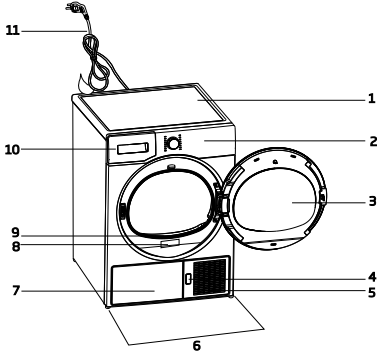

2 Your Dryer

2.1 Overview

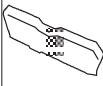

1. Top panel
2. Control panel
3. Loading door
4. Kick plate opening button
5. Ventilation grids
6. Adjustable legs
7. In models where the tank is placed below, the water tank is inside the toe board
8. Type label
9. Lint filter
10. Water tank drawer (in models where the tank is placed above)
11. Power cord

2.2 Package Contents

	1. Water drain hose *		5. Drying basket user manual*
	2. Filter drawer spare sponge*		6. Water Filling Container*
	3. User Manual		7. Pure Water*
	4. Drying basket*		8. Fragrance Capsules Group*

*It can be supplied with your machine depending on its model.

3 Installation

Before the calling the nearest Authorized Service for the installation of the dryer, ensure that electrical installation and water drain is appropriate referring to the user's manual. If they are not suitable, contact a qualified electrician and technician to make necessary arrangements.



NOTE

- Preparation of the dryer's location as well as the electrical and waste water installations is under customer's responsibility.



WARNING!

- Prior to installation, visually check if the dryer has any defects on it. If the drier is damaged, do not have it installed. Damaged products cause risks for your safety.
- Let your dryer wait for 12 hours before starting to use it.

3.1 Appropriate installation location

Install the dryer on a stable and level surface. Dryer is heavy. Do not move it by yourself.

- Operate your dryer in a well ventilated, dust-free environment.
- The gap between the dryer and the surface should not be reduced by the materials such as carpet, wood and tape.
- Do not cover the ventilation grills of the dryer.
- There must not be a lockable, sliding or hinged door that may block the opening of the loading door in the place where your dryer is to be installed.
- Once the dryer is installed, it should stay at the same place where its connections have been made. When installing the dryer, make sure that its rear wall does not touch anywhere (tap, socket, etc.).
- Place the dryer at least 1 cm away from the edges of other furniture.
- Your dryer can be operated at temperatures between +5°C and +35°C. If the operating conditions fall outside of this range, operation of the dryer will be adversely affected and it can get damaged.

- The rear surface of the tumble dryer shall be placed against a wall.



DANGER!

Do not place the dryer on the power cable.

* Ignore following warning if your product's system does not contains R290.



DANGER!

- Dryer contains R290 refrigerant.*
- R290 is an environment-friendly, but flammable refrigerant.*
- Ensure that the air inlet of the dryer is open and it is well-ventilated.*
- Keep potential flame sources away from the dryer.*

3.2 Removing the transportation safety assembly



WARNING!

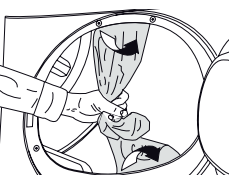

- Remove the transportation safety assembly before using the dryer for the first time.
- If the door swing side of your appliance can be modified, see the reversible door mounting instructions.

3.3 Connecting to the drain

You can directly drain accumulated water through the water drain hose supplied with the product instead of periodically draining the water collected in the water tank.

Connecting the water drain hose

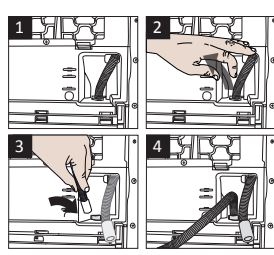

1-2 Pull hose at the behind of the dryer by hand in order to disconnect it from where it is connected. Do not use any tools to remove the hose.

3 Connect one end of the drain hose supplied with the dryer to the connection point from where you removed the hose of the product in previous step.

4 Connect the other end of the drain hose directly to the wastewater drain or to the washbasin.



NOTE

- Water drain hose should be attached to a height of maximum 80 cm.
- Make sure that the water drain hose is not stepped on and it is not folded between the drain and the machine.
- If there is an accessories pack supplied with your product, please see the detailed description.

3.4 Adjusting the feet

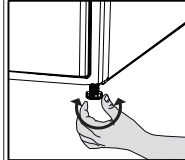

- Turn the feet to left or right until the dryer stands level and firmly.

3.5 Transportation of the dryer

Drain all water that has remained in the dryer. If direct water drain connection is made, then remove the hose connections.



WARNING!

- We recommend carrying the dryer in upright position. If it is not possible to carry the machine in the upright position, we recommend carrying it by tilting towards the right side when looked from the front.

3.6 Warnings about sounds



NOTE

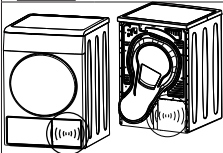

- It is normal to hear a metallic noise from the compressor sometimes during operation.
- Water collected during operation is pumped to water tank. It is normal to hear pumping noise during this process.

3.7 Changing the illumination lamp

In case an illumination lamp is used in your laundry dryer. To change the Bulb/LED used for illumination of your tumble dryer, call your Authorized Service. The lamp(s) used in this appliance is not suitable for household room illumination. The intended purpose of this lamp is to assist the user to place laundry in the tumble dryer in a comfortable way. The lamps used in this appliance have to withstand extreme physical conditions such as vibrations and temperatures above 50 °C

4 Preparation

4.1 Laundry suitable for drying in the dryer

Always obey the instructions given on the garment tags. Dry only the laundry having a label stating that they are suitable for drying in a dryer.

4.2 Laundry not suitable for drying in the dryer



Do not dry with dryer

Items with this symbol should not be dried in the dryer.



NOTE

- Delicate embroidered fabrics, woollen, silk garments, delicate and valuable fabrics, airtight items and tulle curtains are not suitable for machine drying.

4.3 Preparing laundry for drying

- Laundry may be tangled with each other after washing. Separate the laundry items before placing them into the dryer.
- Dry garments having metal accessories such as zippers, inside out.
- Fasten the zippers, hooks and buckles and button sheets.

4.4 Things to be done for energy saving

- Spin your laundry at the highest speed possible when washing them. Thus, the drying time is shortened and energy consumption is reduced.
- Sort out the laundry depending on their type and thickness. Dry the same type of laundry together. For example thin kitchen towels and tableclothes dries earlier than thick bathroom towels.
- Follow the instructions in the user manual for programme selection.
- Do not open the loading door of the machine during drying unless necessary. If you must open the loading door, do not keep it open for a long time.
- Do not add wet laundry while the dryer is in operation
- For models with a condenser unit: clean

the condenser once in a month or after every 30 operations regularly. .

- Clean the filter periodically. Read the Maintenance and cleaning of filters for detailed information.
- For models with flue unit: comply with the flue connection instructions and clean the flue.
- During the drying process, air the room well where your tumble dryer is operating.

4.5 Correct load capacity

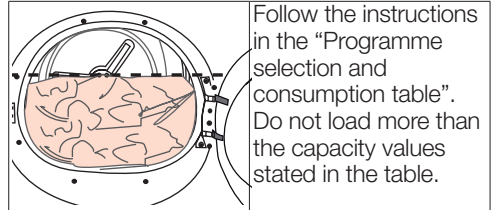

Following weights are given as examples.

Laundry	Approximate weights (g)*	Laundry	Approximate weights (g)*
Cotton quilt covers (double)	1500	Blouses	150
Cotton quilt covers (single)	1000	Cotton shirts	300
Bed sheets (double)	500	Shirts	250
Bed sheets (single)	350	Cotton dresses	500
Large tablecloths	700	Dresses	350
Small tablecloths	250	Jeans	700
Tea napkins	100	Handkerchiefs (10 pieces)	100
Bath towels	700	T-Shirts	125
Hand towels	350		

*Dry laundry weight before washing.

5 Operating the product

5.1 Control Panel

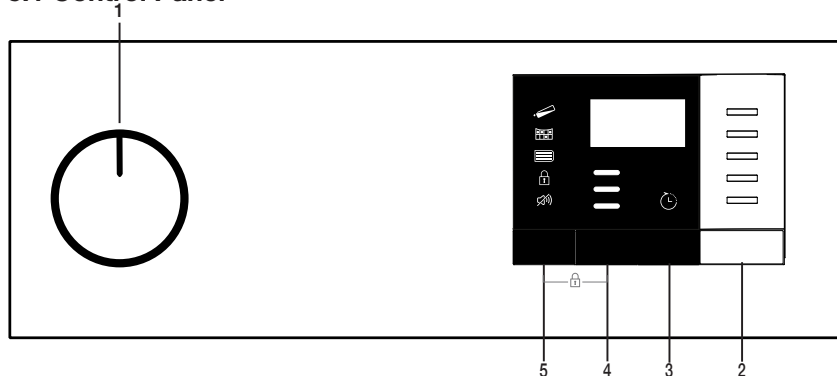

1. On/Off/Program selection button
2. Start/Stand-by button

3. End Time button
4. Drying Level Button
5. Buzzer volume/Time programs selection button

5.2 Symbols

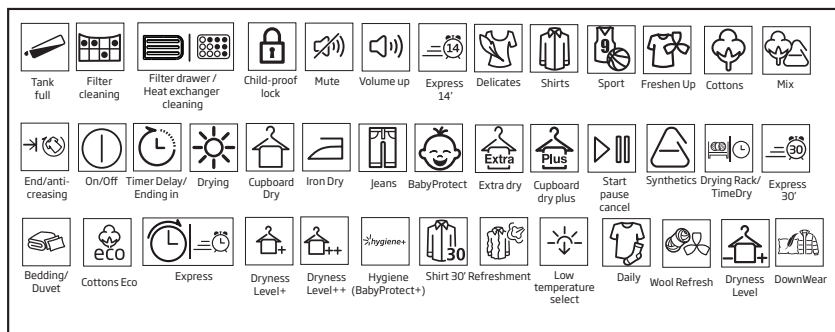

5.3. Preparation of drying machine

- Plug the drying machine.
- Open the loading door.
- Place the laundry to the drying machine without jamming them.
- Push and close the loading door.

Select the desired program using the On/Off/ Program selection knob, the machine will turn on.



NOTE

- Selecting a program using the On/Off/ Program selection button does not mean that the program started. Press the Start / Stand-by button to start the program.

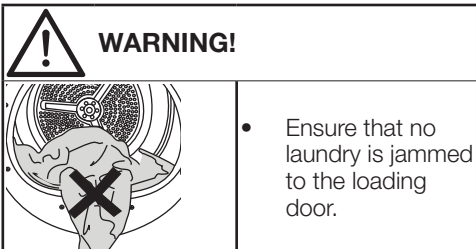

5.4 Program selection and consumption chart

EN				
Programmes	Programme Description	Capacity (kg)	Spin speed in washing machine (rpm)	Drying Time (minutes)
Cottons Iron Dry	You may dry your cotton laundry to be ironed in this program to have them slightly damp for ease of ironing. (Shirt, T-shirt, tablecloth, etc.)	7	1000	145
Cottons Eco	You may dry all your cotton laundry in this program. (T-shirt, pants, pyjamas, baby clothes, underwear, linen, etc.) You can put your laundry in the wardrobe without ironing.	7	1000	179
Cottons Cupboard Dry	You may use this program for extra dryness in thick laundry such as pants, tracksuit. You can put your laundry in the wardrobe without ironing.	7	1000	204
Cottons Extra Dry	You may dry your thick cotton laundry in this program such as towels, bathrobe, etc. You can put your laundry in the wardrobe without ironing.	7	1000	214
Synthetics Iron Dry	You may dry your synthetic laundry to be ironed in this program to have them slightly damp for ease of ironing. (Shirt, T-shirt, tablecloth, etc.)	3,5	800	55
Synthetics Cupboard Dry	You may dry all your synthetic laundry in this program. (Shirt, T-shirt, underwear, tablecloth, etc.) You can put your laundry in the wardrobe without ironing.	3,5	800	70
Timer Programmes	You may select from time programmes between 10 and 160 minutes to achieve the desired drying level at low temperature. In this programme, tumble drier's operation lasts for the set time independently from the dryness of laundry.	-	-	-
Freshen Up	Ventilates for 10 minutes without blowing hot air. You can ventilate the cotton and linen clothes that have been enclosed for a long time with this program to remove their odour. You can use this program to ventilate and soften wool laundry that can be washed in a washing machine. Do not use for full drying.	-	-	10
Gentle Care / Shirts	It dries the shirts in a more sensitive manner, and causes less creasing and easier ironing.	1,5	1200	50
Jeans	You may dry denim pants, skirts, shirts or jackets in this program.	4	1200	140
Outdoor/Sports	Use it to dry your clothes made of synthetics, cotton or mixed fabrics or waterproof products such as functional jacket, raincoat etc. Turn them inside out prior to drying.	2	1000	130
Mix(Daily)	You can dry both cotton and synthetic laundry with this programme. Sports and fitness clothes may be dried with this program.	4	1000	125

Hygiene +	It is a long-term program that you can use for the clothes (baby clothes, towels, underwear, etc. cotton) you require hygiene. Hygiene is provided with high temperature. It is especially suitable for durable fabrics. ((This program is identified and approved by England's "The British Foundation" (Allergy UK).))	5	800	195
Downwear	You can dry your clothes such as coats and jackets with feathers and fibers which have a label that can be dried in the dryer. Please dry inside out.	-	800	100
Daily Express	Use this program to have 2 shirts ready for ironing.	0,5	1200	30
Energy consumption values				
Programmes	Capacity (kg)	Spin speed in washing machine (rpm)	Approximate amount of remaining humidity	Energy consumption value kWh
Cottons Eco *	7	1000	60%	1,75
Cottons Iron dry	7	1000	60%	1,40
Synthetics cupboard dry	3,5	800	40%	0,65
	"Cottons Eco programme" used at full and partial load is the standard drying programme to which the information in the label and the fiche relates, that this programme is suitable for drying normal wet Cottons laundry and that it is the most efficient programme in terms of energy consumption for Cottons.			

* : Energy Label standard program (EN 61121:2012) All values in the table are determined according to EN 61121:2012 standard. Consumption values may vary from the values in the chart depending on laundry type, wringing speed, ambient conditions and voltage levels.



Allergy UK is the brand of the British Allergy Association. Seal of Approval is created to guide people that require recommendation about a product that the related product restricts / reduces / eliminates the allergens or reduces the allergen content significantly in the ambient where allergy patients exist. It aims to provide assurance that the products are tested scientifically or examined in a way to provide measurable results.

5.5 Auxiliary functions

Buzzer / time

Drying machine makes an audible warning when the program is completed. If you don't want the machine to make an audible warning, press the "Buzzer / Time" button. When you press the Buzzer/Time button, a light will illuminate and no audible warning will be made when the program ends.



NOTE

- You can select this function before or after the program starts.

Buzzer/Time button is used to adjust program duration while the Rack/Time programs are selected.

Drying Level

Drying Level button is used for adjusting to desired dryness level. Program duration may change depending on the selection.



NOTE

- You can activate this function only prior to start of program.

End time

You can delay the end time of the program up to 24 hours with End time function.

1. Open the loading door and place the laundry.
2. Select the drying program.
3. Press the End Time selection button and set the delay time you wish. End Time LED will illuminate. (When pressed and hold the button, End Time proceeds non-stop).
4. Press the Start / Stand-by button. End Time countdown starts. ":" Separator in

the middle of displayed delay time flashes.



NOTE

- You can add or remove laundry within end time. Displayed time is the sum of normal drying time and end time. End Time LED will turn off at the end of countdown, drying starts and drying LED will illuminate.

Changing the end time

If you want to change the duration during the countdown:

Cancel the program by turning the On/Off/ Program selection knob. Select the program you want and repeat the End Time selection process.

Cancel the end time function

If you want to cancel the end time countdown and start the program immediately:

Cancel the program by turning the On/Off/ Program selection knob. Select the program you want and press the Start/Stand-by button.

5.6 Warning indicators



NOTE

- Warning indicators may vary depending on the model of your dryer.

Filter cleaning

When the program is completed, the warning indicator for filter cleaning turns on.

Water tank

When the program is completed, the warning indicator to empty the water tank turns on.

If the water tank fills up while the program continues, the warning indicator starts flashing and the machine goes into stand-by. In this case, empty the water tank and start the program by pressing the Start / Stand-by button. Warning indicator turns off and program resumes.

Filter drawer /Heat exchanger cleaning

When the programme is finished, the cleaning symbol of the heat exchanger or filter drawer may light up.

5.7 Starting the program

Press the Start/Stand-by button to start the program.

Start/Stand-by and Drying indicators will illuminate to indicate that program started.

5.8 Child Lock

The drying machine has a child lock which prevents the program flow from being interrupted when the buttons are pressed during a program. When the child lock is activated, all buttons on the panel except the On/Off/Program selection knob are deactivated.

Press the Drying Level and Buzzer buttons simultaneously for 3 buttons to activate the child lock.

The child lock has to be deactivated to be able to start a new program after the current program is finished or to be able to interfere with the program. To deactivate the child lock, keep the same buttons pressed for 3 seconds.



NOTE

- When the child lock is activated, the child lock warning indicator on the screen turns on.
- Child lock deactivates when the drying machine is turned off and on by the On/Off/Cancel knob.



NOTE

- When the drying machine runs and the child lock is active, it beeps twice when the program selection knob is turned. If the child lock is deactivated without returning the program selection knob to its previous position, program will terminate due to the change in the program selection knob position.

5.9 Changing the program after it is started

You can change the program you selected to dry your laundry with a different program after the drying machine starts running

- For instance, select Extra Dry program by turning the On/Off/Program selection knob to select Extra Dry instead of Iron Dry.
- Press the Start/Stand-by button to start the program.

Adding and removing clothes during stand-by

If you want to add or remove clothes to/from the drying machine after the drying program starts:

- Press the Start/Stand-by button to put the drying machine in Stand-by state. The drying operation stops.
- Open the loading door while in Stand-by state, and close the door after you remove or add laundry.
- Press the Start/Stand-by button to start the program.



NOTE

- Adding laundry after the drying operation starts may cause the dried laundry inside the machine to mix with wet laundry and leave the laundry damp at the end of operation.
- Adding or removing laundry during drying may be repeated as many times as you wish. But this operation continuously interrupts the drying operation, and thus increases program duration and energy consumption. So, it is recommended to add laundry before the program starts.
- If a new program is selected by turning the program selection knob while the drying machine is in stand-by, the running program terminates.



WARNING!

- Do not touch the inner surface of the drum while adding or removing clothes during a continuing program. The drum surface is hot.

5.10 Cancelling the program

If you want to cancel the program and terminate the drying operation for any reason after the drying machine starts running, turn the On/Off/Cancel knob, the program will be cancelled.



WARNING!

- The inside of the drying machine shall be extremely hot when you cancel the program during machine operation, so run the refresh program to allow it to cool down.

5.11 End of program

When the program ends, the Fibre Filter Cleaning and Water Tank warning symbols on the program observation indicator turn on. Loading door may be opened and the dryer machine becomes ready for another run. Bring the On/Off/Program selection knob to On/Off position to turn the drying machine off.



NOTE

- If the laundry is not removed after the program is completed, the wrinkle prevention function activates for 2 hours to prevent the laundry inside the machine to get wrinkled. The program tumbles the laundry with 10-minute intervals to prevent them from wrinkling.

6 Maintenance and cleaning

6.1 Loading Door Inner Surface

The hair and fibres that are separated from the laundry during drying process is collected by the Fibre Filter.



NOTE

- Fibres are formed during wearing and washing clothes.
- You can clean the filter slot with a vacuum cleaner.



WARNING!

- After each drying cycle, clean the fibre filter and the inner surface of the loading door.

To clean the fibre filter:

- Open the loading door.
- Hold the first part (inner filter) of the two part fibre filter and remove it by pulling it upwards.
- Collect the hair, fibres and cotton balls with hand or with a soft cloth.
- Remove the second part (outer filter) by pulling it upwards.

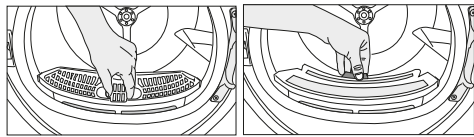

NOTE

- Ensure that hair, fibre and cotton balls do not fall into the slot where the filters are installed.
- Open both fibre filters (inner and outer filters) remove the hair, fibre, cotton balls with your damp hand or a vacuum cleaner or a cloth.

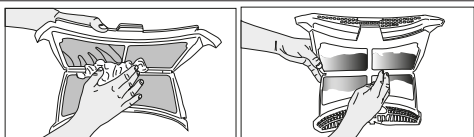

- Clean both filters under water running in reverse direction of fibre accumulation or with a soft brush. Dry the filter before placing it back.

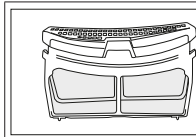
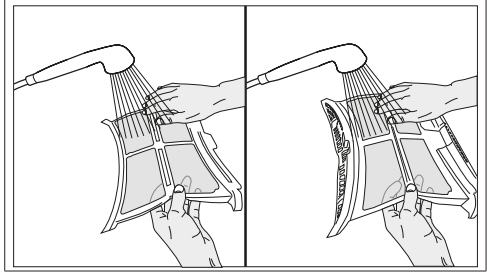

- Insert the fibre filters on one another and place it back in its place.

- Clean the loading door interior and its washer with a soft damp cloth.

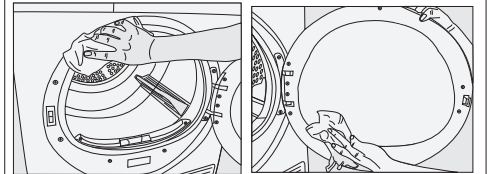

6.2 Cleaning the sensors

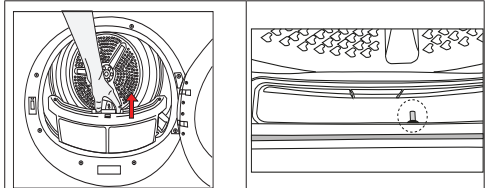

- There are temperature sensor in the dryer that detect whether the laundry is dry or not.

To clean the sensors:

- Open the loading door of the dryer.
- Remove the lint filter by pulling it up.
- Clean the sensor with your hand if any fluff accumulation on it.



NOTE

- Clean the sensor 4 times a year.
- Do not use metal tools when cleaning the sensor.
- Allow the machine to cool down if it is still hot due the drying process.



WARNING!

- Never use solvents, cleaning agents or similar substances for cleaning due to the risk of fire and explosion!

6.3 Draining the water tank

Dampness of the laundry is removed and condensed during drying process and the water that arise accumulates in the water tank. Drain the water tank after each drying cycle.



WARNING!

- Condensed water is not drinkable!
- Never remove the water tank when the program is running!

If you forget to drain the water tank, the machine will stop during the subsequent drying cycles when the water tank is full and the Water Tank warning symbol will flash. If this is the case, drain the water tank and press Start / Pause button to resume the drying cycle. To drain the water tank:

1. Remove the water tank in the drawer or container carefully.

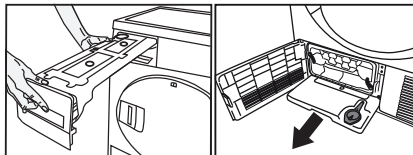

2. Drain the water in the tank.

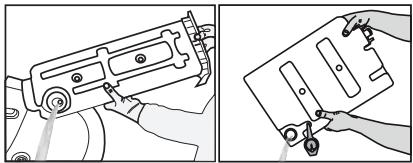

- If there is lint accumulation in the funnel of the water tank, clean it under running water.
- Place the water tank into its seat.



NOTE

- If the direct water draining is used as an option, there is no need to empty the water tank.

6.4 Cleaning the evaporator

The hair and fibres that are not caught by the fibre filter goes to the fins of the evaporator behind the toe board and accumulates here. If the evaporator "☰" icon is flashing or in 3 month periods, clean the evaporator.

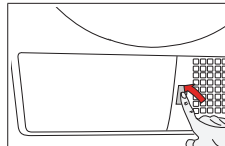

- Open the toe board by pressing on it.

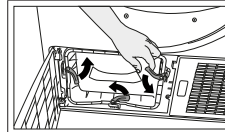

- To open the air routing door, move the release latch.

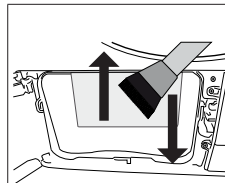

- Clean the fibres on the evaporator with a damp cloth / vacuum cleaner with a brush by moving upwards and downwards.

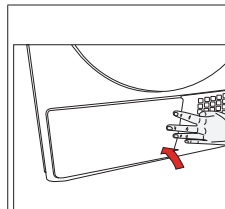

- After the cleaning process is completed, place the air router door to its place, move the latches to close it and close the toe board.



WARNING!

- You can clean by hand, provided you wear protective gloves. Do not try to clean with bare hands. Evaporator fins may damage your hands.
- Cleaning by left to right movements may damage the evaporator fins. This may lead to drying issues.

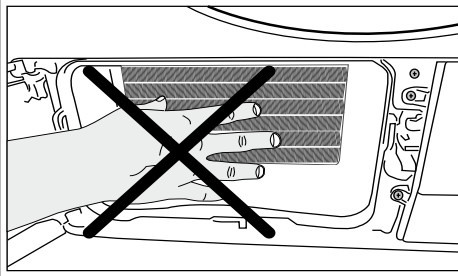

7 Troubleshooting

Drying operation takes too long.
Fibre filter (interior and exterior filter) pores may be clogged. >>> Wash the fibre filters with warm water and dry. Evaporator front side may be clogged. >>> Clean the front side of the evaporator. The ventilation grills in front of the machine may be closed. >>> Remove any object in front of the ventilation grills that blocks air. Ventilation may be inadequate because the are the machine is installed in is too small. >>> Open the door or windows to prevent the room temperature from rising very high. A lime layer may have accumulated on the humidity sensor. >>> Clean the humidity sensor. Excessive amount of laundry might be loaded. >>> Do not load the drying machine excessively. Laundry might not have been wrung adequately. >>> Perform a higher speed wringing on the washing machine.
Clothes come out damp after drying.
A program not suitable for the laundry type may have been used.>>> Check the maintenance labels on the clothes and select a program suitable for the clothes' type or use time programs as extra. Fibre filter (interior and exterior filter) pores may be clogged. >>> Wash the filters with warm water and dry. Evaporator front side may be clogged. >>> Clean the front side of the evaporator. Excessive amount of laundry might be loaded. >>> Do not load the drying machine excessively. Laundry might not have been wrung adequately. >>> Perform a higher speed wringing on the washing machine.
Drying machine does not turn on or program cannot be started. Drying machine does not run after it is configured.
Power plug might be unplugged. >>> Make sure the power cord is plugged in. Loading door might be open. >>> Ensure that the loading door is properly closed. A program might not be set or Start / Pause /Cancel button might not be pressed. >>> Check that the program is set and it is not in Pause position.. Child lock may be activated. >>> Turn off the child lock.
Program terminated prematurely for no reason.
Loading door might be closed completely. >>> Ensure that the loading door is properly closed. There might be a power outage. >>> Press the Start / Pause / Cancel button to start the program. Water tank may be full. >>> Empty the water tank.
Clothes have shrunk, hardened or spoiled.
A program not suitable with the laundry type might have been used. >>> Check the maintenance labels on the clothes and select a program suitable for the clothes.
Water drips from the loading door.
Fibres might have gathered on the inner sides of the loading door and the loading door gasket. >>> Clean the inner surfaces of the loading door and the loading door gasket surfaces.
Loading door opens by itself.
Loading door might be closed completely. >>> Push the loading door until the closing sound is heard.

Water tank warning symbol is on/flashing.
Water tank may be full. >>> Empty the water tank. Water discharge hose might have collapsed. >>> If the product is connected directly to the water drain check the water discharge hose.
The lighting inside the drying machine does not turn on. (In models with lamp)
The drying machine might not have been turned on using On/Off button. >>> Check that the drying machine is turned on. Lamp might be malfunctioning. >>> Contact Authorized Service to replace the lamp.
Anti-crease icon is lit.
Anti-Crease mode that prevents the laundry in the drier to crease may be activated. >>> Turn the drier off and remove the laundry.
Fibre filter cleaning icon is lit.
Fibre filter (interior and exterior filter) may be unclean. >>> Wash the filters with warm water and dry.. A layer may be formed on the fibre filter pores that leads to clogging. >>> Wash the filters with warm water and dry. Fibre filters may not be inserted. >>> Insert the interior and exterior filters to their places.
An audible warning is heard from the machine
Fibre filters may not be inserted. >>> Insert the interior and exterior filters to their places.
Evaporator warning icon is flashing.
Evaporator front side may be clogged with fibres. >>> Clean the front side of the evaporator. Fibre filters may not be inserted. >>> Insert the interior and exterior filters to their places.
The lighting inside the drying machine turns on. (In models with lamp)
If the drying machine is plugged to the power outlet, the On/Off button is pressed and the door is open; the light turns on. >>> Unplug the drying machine or bring the On/ Off button to Off position.

	WARNING!
<ul style="list-style-type: none">• If the problem persists after following the instructions in this section, contact your vendor or an Authorized Service. Never try to repair your product yourself.	

	NOTE
<ul style="list-style-type: none">• In an event that you encounter an issue on any part on your appliance, you can ask for a replacement by contacting the authorized service with the appliance model number.• Operating the appliance with non-authentic parts may lead the appliance to malfunction.• Manufacturer and distributor are not liable for malfunctions resulting from using non-authentic parts.	

PRODUCT FICHE

Complying Commission Delegated Regulation (EU) No 392/2012

Supplier name or trademark		BEKO
Model name		DF7412PA 7188301400
Rated capacity (kg)		7.0
Type of Tumble Dryer	Air Vented	-
	Condenser	•
Energy efficiency class ⁽¹⁾		A++
Annual Energy Consumption (kWh) ⁽²⁾		212,0
Type of Control	Automatic	•
	Non-automatic	-
Energy consumption of the standard cotton programme at full load (kWh)		1,75
Energy consumption of the standard cotton programme at partial load (kWh)		0,96
Power consumption of the off-mode for the standard cotton programme at full load, P ₀ (W)		0,50
Power consumption of the left-on mode for the standard cotton programme at full load, P _L (W)		1,00
The duration of the left on mode (min)		30
Standard cotton programme ⁽³⁾		•
Programme time of the standard cotton programme at full load, T _{dry} (min)		179
Programme time of the standard cotton programme at partial load, T _{dry1/2} (min)		107
Weighted programme time of the standard cotton programme at full and partial load (T _w)		138
Condensation efficiency class ⁽⁴⁾		B
Average condensation efficiency of the standard cotton programme at full load, C _{dry}		81%
Average condensation efficiency of the standard cotton programme at partial load, C _{dry1/2}		81%
Weighted condensation efficiency of the standard cotton programme at full load and partial load, C _w		81%
Sound power level for the standard cotton programme at full load ⁽⁵⁾		65
Built-in		-

• : Yes - : No

(1) Scale from A+++ (most efficient) to D (least efficient)

(2) Energy consumption based on 160 drying cycles of the standard cotton programme at full and partial load, and the consumption of the low-power modes. Actual energy consumption per cycle will depend on how the appliance is used.

(3) "Cotton cupboard dry programme" used at full and partial load is the standard drying programme to which the information in the label and the fiche relates, that this programme is suitable for drying normal wet cotton laundry and that it is the most efficient programme in terms of energy consumption for cotton

(4) Scale from G (least efficient) to A (most efficient)

(5) Weighted average value — L_{WA} expressed in dB(A) re 1 pW

Kérjük, először olvassa el a használati útmutatót!

Kedves Vásárló!

Köszönjük, hogy egy Beko terméket választott. Reméljük, hogy az ön által megvásárolt, korszerű körülmények között gyártott gép a legjobb eredményt nyújtja majd önnek. Azt tanácsoljuk, hogy az első használat előtt alaposan olvassa végig ezt a használati útmutatót és a kísérő dokumentumokat, majd tartsa azt meg a továbbiakban is. Ha másnak adná át a terméket, mellékelje a használati útmutatót is. Ügyeljen az útmutatóban található részletekre és a figyelmeztetésekre, és kövesse azokat. Ezt a használati útmutatót a fedlapján látható modellhez használja.



- Olvassa el a használati útmutatót.

Jelmagyarázat

A használati útmutatóban a következő jelzések fordulnak elő:



VESZÉLY!

- Áramütéssel kapcsolatos figyelmeztetés.



VESZÉLY!

- Tűzveszéllyel kapcsolatos figyelmeztetés.



FIGYELMEZTETÉS!

- A veszélyes helyzetekkel kapcsolatos figyelmeztetések, tekintettel az élet- és vagyonbiztonságra.



FIGYELMEZTETÉS!

- Forró felületekkel kapcsolatos figyelmeztetés.



FIGYELMEZTETÉS!

- Figyelmeztetés a leforrzás veszélyére



MEGJEGYZÉS

- Fontos információk, illetve a használatlaltal kapcsolatos hasznos útmutatók.



A termék csomagolóanyagait, a nemzeti környezetvédelmi szabályzásnak megfelelően újrahasznosítható anyagokból gyártottuk.

Ne dobja ki a csomagolóanyagokat háztartási vagy más hulladékkal együtt, azokat a helyi hatóságok által kijelölt csomagolóanyag gyűjtőpontoknál dobja ki.



Ez a termék a legmodernebb technológiák felhasználásával készült, környezetbarát körülmények között.

1 Fontos utasítások a biztonság és környezet kapcsán



MEGJEGYZÉS

- Ez a fejezet olyan biztonsági információkat tartalmaz, melyek segítenek megelőzni a személyi sérülések és az anyagi károk kockázatát. Az előírások figyelmen kívül hagyása a garancia elvesztésével jár.

1.1 General safety



FIGYELMEZTETÉS!

- A készülék használható 8 éves és ennél nagyobb gyermekek által, valamint csökkentett fizikális, érzékelési vagy mentális készségekkel rendelkező személyek által, vagy tapasztalattal és tudással nem rendelkező személyek által, ha őket a biztonságukért felelős személy a készülék használatával kapcsolatban tájékoztatással vagy iránymutatással látta el. Ne hagyja a gyermekeket a készülékkel játszani. A tisztítási és karbantartási műveleteket gyermekek felügyelet nélkül nem végezhetik.
- Ha a gyermekek nincsenek folyamatos felügyelet alatt, tartsa távol a 3 éven aluli gyermekeket.
- Az állítható lábat nem szabad eltávolítani. A szárító és a padló közötti távolságot nem szabad olyan anyagokkal csökkenteni, mint pl. a szőnyeg, fa vagy a szerelőszalag. Ez problémákat okoz a szárítónál.



FIGYELMEZTETÉS!

- A beszerelési és javítási munkákat mindig bízza Szakszervizre. A gyártó nem vállal felelősséget azokért a károkért, melyek képzetlen személy által végzett javítási munkák következtében következnek be.
- Soha ne tisztítsa úgy a szárítót, hogy vizet permetez vagy borít rá! Ezzel áramütés veszélyének teszi ki magát

Gőzölő funkcióval rendelkező termékek esetében:



FIGYELMEZTETÉS!

- Csak desztillált vizet vagy a gép víztartályában lecsapódott vizet használja a gőzölős programokkal. Ne használjon vezetékes vizet vagy adalékanyagokat. A víztartályban összegyűlt víz használata során szűrje meg és távolítsa el belőle a szálakat.
- A gőzölő program üzeme közben ne nyissa ki az ajtót. Forró víz csapódhat ki.
- Mielőtt gőzölő programot állít be a ruhának, távolítsa el a foltokat.
- Csak olyan ruhákhoz állítsa be a gőzölő programot, amelyek nem piszkosak vagy foltosak, csak valamilyen kellemetlen szag járja át őket (szageltávolító).
- Sem a gőzölő, sem más program során ne használjon vegytisztító szereket vagy kiegészítő anyagokat.

1.1.1 Electrical safety



VESZÉLY!

- **Az elektromos biztonsági utasításokat a beszerelés során az elektromos csatlakozással kapcsolatban követni kell.**
- **A berendezést tilos külső kapcsoló berendezésen keresztül csatlakoztatni, mint amilyenek az időzítő, vagy olyan áramkörre kapcsolni, amelyet egy berendezés rendszeresen bekapcsol és kikapcsol.**
- Az olajjal, acetonnal, alkohollal, fűtőolajjal, kerozinnal, feltöltővel, szerekkel, terpentinrel, paraffinnal, paraffin eltávolító szerekkel, benzinnel, viasszal vagy viaszos eltávolító szerekkel szennyezett tárgyakat bő vízzel kell lemosni, mielőtt a szárítóban szárítanák.
- A feszültség és a megengedett biztosítékos védelem adatait a típuscímke lemezen találja.
- A típuscímken látható feszültségnek meg kell egyeznie a hálózati feszültséggel.
- Ha nincs használatban a szárító, áramtalanítsa.
- Telepítés, karbantartás, tisztítás és javítási munkálatok közben, húzza ki a szárítót a hálózati csatlakozóból.



VESZÉLY!

- Nedves kézzel ne érintse meg a csatlakozót! Az áramtalanítást soha ne a zsinór húzásával végezze, mindig a csatlakozónál fogva húzza ki.
- Az áramütés és tűz kockázatának csökkentése érdekében, a szárítót ne csatlakoztassa hosszabbítókkal, többdugaszos aljzatokkal vagy adapterekkel az elektromos hálózathoz.
- A gép beszerelése után a tápkábel dugójának könnyen hozzáférhetőnek kell lennie.
- **A sérült tápkábelt a szakszerviz értesítésével le kell cserélni.**
- **Ha a készülék meghibásodása esetén, a javítás szakszervizzel való elvégzéséig nem üzemeltethető! Ezzel áramütés veszélyének teszi ki magát!**

1.1.2 Termék biztonság



FIGYELMEZTETÉS!

- Győződjön meg arról, hogy a szárító levegő bemenete nyitva van, és jól szellőzik.
- A termék R290 hűtőközeget tartalmaz.
- Az R290 egy környezetbarát, de gyúlékony hűtőközeg.
- Tartsa távol a terméket olyan potenciális hőforrásoktól, amelyek meggyulladhatnak.



VESZÉLY!

A tűzveszéllyel kapcsolatosan megfontolandó pontok:

- A meghatározott mosott cikkeken kívül, más nem szárítható a szárítóban, tűzveszély miatt.
- Mosatlan ruhaneműk
- A olajjal, acetonnal, alkohollal, gázolajjal, kerozinnal, folteltávolítóval, terpentinnel, parafinnal vagy parafin-eltávolítóval szennyezett ruhaneműt a szárítás előtt forró, oldószeres vízben kell lemosni.
- Ezért, főleg az olyan anyagokat melyekben a fent meghatározott foltok vannak, alaposan ki kell mosni, ahhoz megfelelő mosószer kell használni, magas mosási hőmérsékleten.

Az alább meghatározott mosott cikkeken kívül, más nem szárítható a szárítóban, tűzveszély miatt:



VESZÉLY!

- Gumihabbal (latex hab) bevont ruhák vagy párnák, fürdőköpenyek, vízálló textíliák, gumi erősítéssel ellátott anyagok és gumihab betétek.
- Ipari kemikáliákkal tisztított ruházat.
- Az olyan tárgyak, mint az öngyújtó, gyufa, aprópénz, fém alkatrészek, tű, stb. károsíthatják a dobot vagy működési problémákhoz vezethetnek. Ezért, ellenőrizze a ruhát, amit a szárítóba kíván tenni.
- Soha ne állítsa meg a szárítót mielőtt a program befejeződné. Ha mégis így kell tennie, távolítsa el a ruhát gyorsan, és fektesse le azokat hogy eloszlassa a hőt. A nem megfelelően mosott ruhák maguktól meggyulladhatnak, még az után is, hogy a szárítás befejeződött.
- Gondoskodnia kell a megfelelő szellőztetésről annak érdekében, hogy az eltérő üzemanyagokkal (pl. nyílt lánggal) üzemelő gépek által kibocsátott gázok ne gyűljenek fel a helységben az utógyújtás hatás miatt.



FIGYELMEZTETÉS!

- Fémrészeket is tartalmazó alsónemű nem szárítható a szárítóban. A szárítógép meghibásodásához vezethet, ha a szárítás alatt a fém részek meglazulnak és letörnek.



MEGJEGYZÉS

- Az öblítőket és hasonló termékeket a gyártó útmutatásai szerint használja.
- Az egyes betöltések előtt vagy után mindig tisztítsa meg a szűrőt. A szárítót soha ne használja bolyhszűrő nélkül.



FIGYELMEZTETÉS!

- Soha ne próbálja saját maga megjavítani a terméket. Hacsak a használati útmutató vagy a szervizkönyv kifejezetten ezt nem javasolja, ne kíséreljen meg semmiféle javítási vagy cserélési műveletet a terméken, még akkor sem, ha tudja, hogy azt hogyan kell kivitelezni. Ellenkező esetben saját és mások életét veszélyezteti.
- Ahol a szárítót beszerelik, nem lehet olyan zárható, toló, vagy zsanéros ajtó, mely akadályozhatja a betöltő ajtó kinyitását.
- Olyan helyre szerelje be a szárítót ami megfelel az otthoni használatnak. (Fürdőszoba, zárt balkon, garázs, stb.)
- Ügyeljen arra, hogy a háziállatok ne másszanak bele a szárító. Használat előtt ellenőrizze a szárító dobját.
- Ne támaszkodjon a szárító betöltő ajtajára amikor az nyitva van, mert az leeshet.
- Ne hagyja, hogy sok szősz gyűljön össze a szárítógép körül.

1.2 Mounting over a washing machine

- Ha a készüléket a mosógép felett kívánja használni, akkor a két gép között rögzítő eszközt kell alkalmazni. A rögzítő eszközt szakképzett személynek kell beszerelnie.
- Ha a mosógép és a szárítógép egymásra van helyezve, teljes töltet esetén körülbelül 180 kg-ot nyomnak együtt. A készülékeket olyan, egyenletes talajra helyezze, mely megfelelő teherbírással rendelkezik!



FIGYELMEZTETÉS!

- A mosógépet nem szabad a szárítóra helyezni. A mosógépre való felszerelésekor, figyeljen oda a fent leírt utasításokra.

Beszerelési táblázat a mosógéphez és a szárítóhoz

Szárítógép mélysége	Mosógép mélysége			
	62 cm	60 cm	54 cm	< 50 cm
54 cm	Beszerelhető		Nem beszerelhető	
60 cm	Beszerelhető		Nem beszerelhető	

1.3 Rendeltetészerű használat

- A szárítót otthoni használatra tervezték. Kereskedelmi célra valamint a rendeltetésétől eltérő módon nem használható.
- A szárítót csak olyan ruhanemű szárításához használhatja, melyen ez megfelelően jelezve van.
- A gyártó elhárítja a helytelen használatból vagy szállításból származó felelősséget.
- Az Ön által megvásárolt szárító élettartama 10 év. Ez idő alatt a szárító megfelelő működtetéséhez elérhetőek lesznek az eredeti pótalkatrészek..

1.4 Gyermekek biztonsága

- A csomagolóanyagok veszélyesek a gyermekek számára. A csomagolóanyagokat tartsa távol a

gyermekektől.

- Az elektromos berendezések veszélyesek a gyermekekre nézve. Ha a gép működik, a gyermekeket ne engedje a közelébe! Ne hagyja, hogy játsszanak a szárítóval! Használjon gyerekbiztos zárat, hogy elkerülje azt, hogy a gyermekek a szárítóval játsszanak.



MEGJEGYZÉS

A gyerekbiztos zár a vezérlőpanelen található. **(Lásd Gyerekzár)**

- Tartsa zárva a betöltőajtót még akkor is, amikor nem használja a szárítót.

1.5 Megfelelés a WEEE előírásnak és a termék leselejtezése



A termék megfelel az uniós WEEE-irányelv (2012/19/EU) követelményeinek. A terméken megtalálható az elektromos és elektronikus hulladékok besorolására vonatkozó szimbólum

(WEEE).

A terméket magas minőségű alkatrészekből és anyagokból állították elő, amelyek ismételten felhasználhatók és alkalmasak az újrahasznosításra. A hulladék terméket annak élettartamának végén ne a szokásos háztartási vagy egyéb hulladékkal együtt selejtezze le. Vigye el azt egy az elektromos és elektronikus berendezések újrahasznosítására szakosodott begyűjtőhelyre. A begyűjtőhelyek kapcsán kérjük, tájékozódjon a helyi hatóságoknál.



VESZÉLY!

- Az R290 egy gyúlékony hűtőközeg. Ezért győződjön meg róla, hogy a rendszer és a csövek nem sérültek-e a működés és a kezelés során.
- Tartsa távol a terméket olyan potenciális hőforrásoktól, amelyek sérülés esetén meggyulladhatnak.
- Ne dobja a terméket tűzbe.

1.6 Az RoHS-irányelvnek való megfelelés:

Az Ön által megvásárolt termék megfelel az uniós RoHS-irányelv (2011/65/EU) követelményeinek. A termék nem tartalmaz az irányelvben meghatározott káros vagy tiltott anyagokat.

1.7 Csomagolási információ

A termék csomagolóanyagai, a nemzeti környezetvédelmi előírásokkal összhangban, újrahasznosítható anyagokból készültek. A csomagolóanyagokat ne a háztartási vagy egyéb hulladékokkal együtt dobja ki! Vigye el azokat a helyi hatóságok által e célból kijelölt csomagolóanyag-begyűjtő pontokra.

1.8 Műszaki Specifikációk

HU

Magasság (min. / max.)	84,6 cm / 86,6 cm*
Szélesség	59,7 cm
Mélység	50,8 cm
Kapacitás (max.)	7 kg**
Nettó súly (± %10)	40 kg
Feszültség	
Névleges bemeneti teljesítmény	Lásd a típuscímkét***
Modellkód	

* Min. magasság: Magasság zárt beállítólábakkal.

Max. magasság: Magasság maximálisan nyitott beállítólábakkal.

** Száraz szennyes súly mosás előtt.

*** A típuscímké a betöltőajtó mögött található.



MEGJEGYZÉS

- A szárító műszaki jellemzői előzetes értesítés nélkül megváltozhatnak a minőség fejlesztése érdekében.
- A jelen használati utasításban található értékek csak sematikus adatok, így elképzelhető, hogy nem egyeznek száz százalékban a termékkel.
- A szárító címkéin vagy a dokumentumokon feltüntetett értékek laboratóriumi körülmények között kerültek meghatározásra, a vonatkozó szabványok szem előtt tartása mellett. A szárító működési és környezeti körülményektől függően az értékek eltérőek lehetnek.

2 Az Ön szárítógépe

2.1 Áttekintése

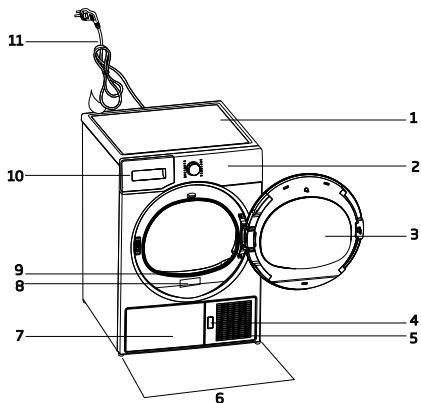

1. Felső panel
2. Vezérlőpanel
3. Betöltőajtó
4. Védőlemez nyitó gomb
5. Szellőzőrácsok
6. állítható lábak
7. Azokban a modellekben, amelyekben a tartály alul található, a víztartály a talplemezen belül van
8. Típusjelölő címke
9. Bolyhszűrő
10. Víztartály-fiók (azokban a modellekben, amelyekben a tartály felül található)
11. Tápkábel

2.2 A csomag tartalma

	1. Víz leeresztő cső		5. Szárítógép használati utasítás*
	2. Szűrőfiók pót- szivacs *		6. Víztöltő tartály*
	3. Használati útmutató		7. Tiszta víz*
	4. Szárító-kosár*		8. Illatkapszula csoport*

*A modelltől függően, tartozéka lehet a gépének.

3 Üzembe helyezés

Mielőtt az Önhöz legközelebbi szakszervizt kihívna a szárítógép bekötése céljából, győződjön meg, hogy az elektromos csatlakozás és a csatornabekötés megfeleljen a használati útmutatóban meghatározott követelményeknek. Ha nem megfelelőek, hívjon képesített villany-, illetve vízvezeték szerelőt a szükséges csatlakozás kialakítása érdekében.



MEGJEGYZÉS

- A szárítógép helyének előkészítése, valamint az elektromos és csatornahálózati bekötés a fogyasztó felelőssége.



FIGYELMEZTETÉS!

- Telepítés előtt szemrevételezéssel győződjön meg, hogy a szárítógép nem sérült. Ha a szárító sérült, ne végeztesse el a bekötését. A sérült termék használata balesetveszélyes lehet.
- A szárítógép használata előtt várjon 12 órát.

3.1 Megfelelő elhelyezés

A szárítót stabil, egyenes felszínen helyezze el.

A szárítógép nehéz. Ne mozgassa egyedül.

- A szárítógépet jól szellőző, pormentes helyiségben használja.
- A szárítógép és a talaj közötti hézagot tilos kitölteni pl. szőnyeggel, fával vagy szalaggal.
- Ne takarja el a szárítógépe szellőzőnyílásait.
- A telepítés helyszínén nem lehet olyan zárható tolóajtó vagy zsanéros ajtó, amely akadályozza a gép töltőajtójának nyitását.
- A szárítógép telepítését követően a gépet azon a helyen kell hagyni, ahol a bekötést elvégezték. A gép telepítésekor győződjön meg, hogy annak hátfala nem ér semmihez (csap, aljzat stb.).
- Helyezze a szárítógépet legalább 1 cm távolságra más berendezési tárgyaktól.
- Az Ön szárítógépét +5°C és +35°C közötti hőmérséklettartományban lehet működtetni. Ettől eltérő körülmények

esetén az üzemeltetés a gépet károsíthatja.

- A szárítógép hátfalát állítsa a falhoz.



VESZÉLY!

A gépet ne állítsa rá a tápkábelre.

*** Hagyja figyelmen kívül a következő figyelmeztetést, ha a termék rendszere nem tartalmaz R290-et**



VESZÉLY!

- A szárító R290 hűtőközeget tartalmaz.*
- Az R290 egy környezetbarát, de gyúlékony hűtőközeg.*
- Győződjön meg arról, hogy a szárító levegő bemenete nyitva van, és jól szellőzik.*
- Tartsa távol a potenciális lángforrásokat a szárítótól.*

3.2 A szállítási biztosító szerelvények eltávolítása



FIGYELMEZTETÉS!

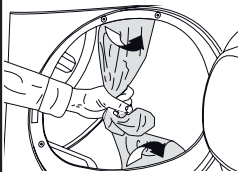

- A szárítógép első használata előtt a szállítási biztosító szerelvényeket el kell távolítani.
- Amennyiben az ajtó nyílásiránya megfordítható, ehhez kövesse a az ajtó szerelésére vonatkozó utasításokat.

3.3 Csatornabekötés

A víztartályban összegyűlt víz időszakos ürítése helyett a vizet a termékkel kapott tömlőn keresztül közvetlenül is ürítheti.

A vízleeresztő tömlő csatlakoztatása

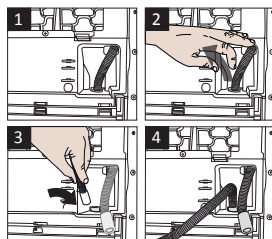

1-2 Kézzeel húzza át a tömlőt a szárító mögött, lecsatlakoztatva a rögzítési helyéről. A tömlő levételéhez ne használjon szerszámot.

3 A szárítógéppel kapott leeresztő tömlő egyik végét csatlakoztassa ahhoz a csatlakozási ponthoz, ahonnan az előző pontban levette.

4 A leeresztő tömlő másikat csatlakoztassa közvetlenül a csatornahálózati csomagra, vagy a mosdókagylóhoz.



MEGJEGYZÉS

- A leeresztő tömlő csatlakoztatási magassága max. 80 cm lehet.
- Ügyeljen, hogy a leeresztő tömlőre ne lépjenek, és az ne szoruljon be a gép és a szerelvény közé.
- Amennyiben a termékhez tartozék csomagot is mellékeltek, lásd a részletes leírást.

3.4 A lábak beállítása

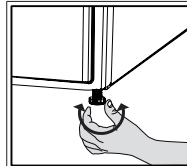

- A lábak jobbra vagy balra forgatásával állítsa a szárítógépet stabil vízszintes helyzetbe.

3.5 A szárítógép szállítása

Üritsen ki minden vizet, ami esetleg a gépben maradt. Ha a gép közvetlenül a csatornabekötő csonkra van csatlakoztatva, csatlakoztassa azt le.



FIGYELMEZTETÉS!

- Javasoljuk, hogy a szárítógépet csak függőleges helyzetben mozgassák. Ha nem lehetséges a függőleges helyzetben való mozgatás, akkor javasoljuk, hogy az előlnézetből jobb kéz felőli oldala felé döntsék meg.

3.6 Hangokra vonatkozó figyelmeztetések



MEGJEGYZÉS

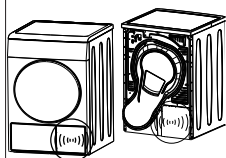

- A működés közben a kompresszor irányából jövő időnkénti fémes zaj normális jelenség.
- A működés közben összegyűlt vizet a gép a víztartályba szivattyúzza. E folyamat során a szivattyúzás zaja normális jelenség.

3.7 A megvilágító izzó cseréje

Ha az Ön készülékében van megvilágítás, az izzó/LED cseréje érdekében hívja a szakszervízt. A szárítógépben használt izzó szokásos háztartási célokra nem használható. A megvilágítás célja, hogy a szárítógép töltését megkönnyítse, kényelmesebbé tegye. A készülékben használt izzó szélsőséges körülményeknek is ellenáll, pl. rezgéseknek és az 50°C-nál magasabb hőmérsékletnek is.

4 Előkészítés

4.1 Gépi szárításra alkalmas ruhaneműk

Mindig tartsa be a ruhanemű címkéjén megadott utasításokat. Csak olyan ruhát szárítson, amely rendelkezik a szárítóban való szárításra alkalmasságot igazoló címkével.

4.2 Gépi szárításra nem alkalmas ruhaneműk



Az ezzel a szimbóolummal ellátott ruhaneműt ne szárítsa szárítóban



MEGJEGYZÉS

- A finom hímzett anyagok, a gyapjú, selyem ruhák, a finom és értékes anyagok, a légzáró anyagok és a túll függönyök nem alkalmasak gépi szárításra.

4.3 A ruhák előkészítése a szárításra

- A mosást követően a ruhanemű összegubancolódhat. Mielőtt a szárítóba helyezi őket, csoportosítsa a ruhaneműt.
- Szárítsa a fém részeket tartalmazó ruhaneműt kifordítva (pl. cipzár).
- Zárja be a cipzárakat, kampókat, csatokat és gombokat.

4.4 Teendők az energiatakarékosság jegyében

- Centrifugáláskor mindig a lehető legmagasabb sebességfokozatot használja. Ily módon a szárítási idő lerövidíthető, az energiafogyasztás pedig csökkenthető.
- A ruhákat típus és vastagság szerint válogassa. Az azonos típusú ruhaneműt együtt szárítsa. Például, a vékony anyagú konyharuhák és asztalterítők gyorsabban száradnak, mint a vastagabb törölközők.
- A megfelelő program kiválasztását illetően tekintse meg a használati útmutatót.
- Szárítás közben ne nyissa ki a gép betöltő ajtáját, csak ha feltétlenül szükséges. Ha mindenképp ki kell nyitnia, csak a lehető legrövidebb ideig tartsa nyitva.

- Működése közben ne adjon hozzá vizes ruhát a szárítóhoz
- Kondenzátor egységgel rendelkező modellek esetében: havonta egyszer vagy minden 30. használatot követően tisztítsa meg a kondenzátort.
- Hőszivattyú egységgel rendelkező modellek esetében: tisztítsa rendszeresen a szűrőfiókot, amikor szemmel láthatóan összegyűlt a szősz, vagy amikor a szűrőfiók-tisztítás jelzőfény felvillan.
- Kürtös modellek esetében: kövesse a kürtő csatlakoztatására vonatkozó utasításokat, és tisztítsa ki a kürtőt.
- A szárítási folyamat során jól szellőztesse ki a helyiséget, ahol a szárítógép működik.

4.5 Helyes ruhamennyiség

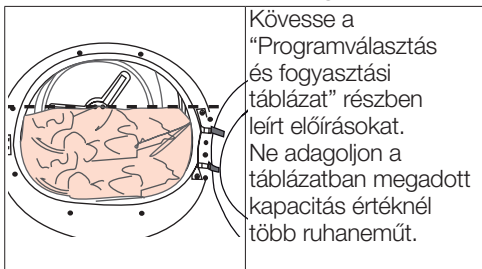

Az alábbi súlyok példaként szerepelnek:

Szennyes	Körülbelüli súly (g)*	Szennyes	Körülbelüli súly (g)*
Pamut paplanhuzat (dupla)	1500	Blúz	150
Pamut paplanhuzat (szimpla)	1000	Pamut ing	300
Lepedő (dupla)	500	Ingek	250
Lepedő (szimpla)	350	Pamut ruha	500
Nagy asztalterítő	700	Ruha	350
Kis asztalterítő	250	Farmer	700
Szalvéta	100	Zsebkendő (10 db)	100
Törölköző	700	Póló	125
Kéztörő	350		

*Szárás szennyes súly mosás előtt..

5 A termék használata

5.1 Kezelőpanel

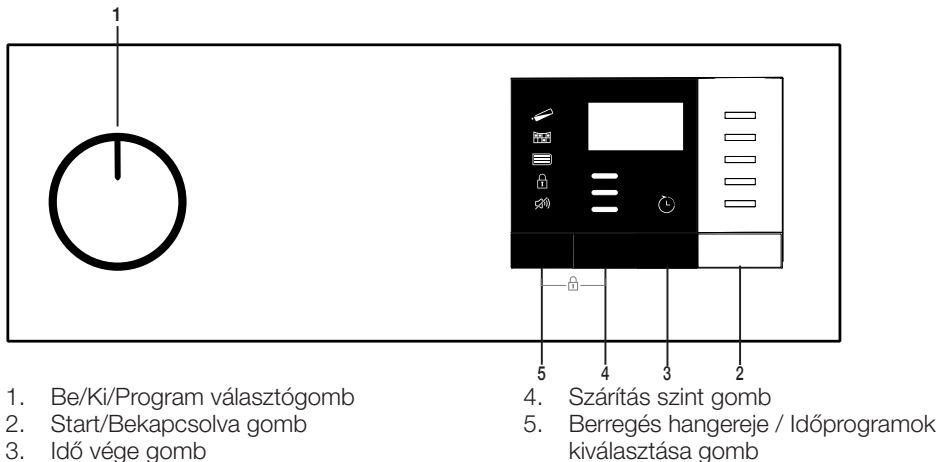

5.2. Szimbólumok

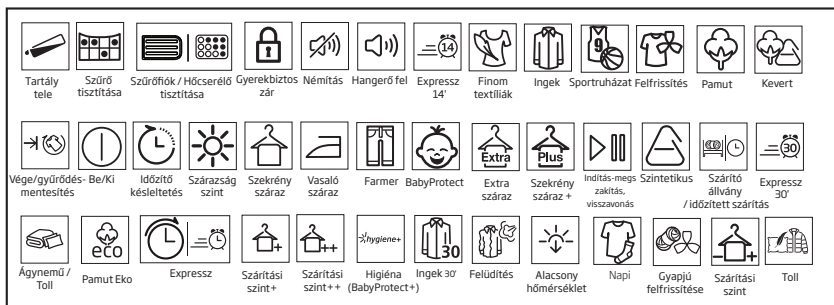

5.3. A szárítógép előkészítése

- Dugja be a szárítógépet.
- Nyissa ki a betöltőajtót.
- Helyezze a ruhát a szárítógépbe, anélkül, hogy teletömné.
- Nyomja be és zárja be a betöltőajtót.

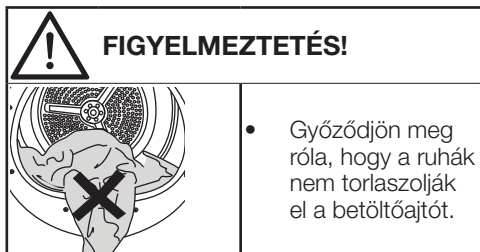

A Be/Ki/Program kiválasztása gomb segítségével válassza ki a kívánt programot, majd a gép bekapcsol.



MEGJEGYZÉS

- Az, hogy a Be/Ki/program kiválasztása gomb segítségével kiválaszt egy programot, nem jelenti azt, hogy a program elindult. A program elindításához nyomja meg az Indítás/Bekapcsola gombot.

5.4 Programkiválasztás és fogyasztási táblázat

HU				
Programok	A programok leírása	Kapacitás (kg)	A mosódob forgási sebessége (ford./perc)	Szárítási idő (perc)
Pamut, vasalásra kész	A vasalandó pamut ruhaneműt száríthatja ezzel a programmal, hogy az egyszerűbb vasalás érdekében egy kicsit nyirkosak legyenek. (ingek, pólók, abroszok stb.)	7	1000	145
Pamut Eko	Ezzel a programmal az összes pamut ruhaneműt száríthatja. (ingek, nadrágok, pizsamák, csecsemőruhák, fehérnemű, ágynemű stb.) A szekrénybe helyezés előtt nincs szükség vasalásra.	7	1000	179
Pamut, szekrényszárász	Ezt a programot vastag ruhaneműk, pl. nadrágok, tréningruhák extra szárításhoz használhatja. A szekrénybe helyezés előtt nincs szükség vasalásra.	7	1000	204
Pamut, extra szárász	Ezzel a programmal vastag pamut ruhaneműket száríthat, mint pl. törölközők, köntös stb. A szekrénybe helyezés előtt nincs szükség vasalásra.	7	1000	214
Szintetikus, vasalásra kész	A vasalandó szintetikus ruhaneműt száríthatja ezzel a programmal, hogy az egyszerűbb vasalás érdekében egy kicsit nyirkosak legyenek. (ingek, pólók, abroszok stb.)	3,5	800	55
Szintetikus, szekrényszárász	Ezzel a programmal az összes szintetikus ruhaneműt száríthatja. (Ingek, pólók, alsónemű, abroszok stb.) A szekrénybe helyezés előtt nincs szükség vasalásra.	3,5	800	70
Időzítő programok	A 10 és 160 perc közötti időprogramok közül választhat a kívánt szárítási szint alacsony hőmérsékleten történő eléréséhez. Ebben a programban a szárítógép működése a ruhanemű szárazságától függetlenül a beállított ideig tart.	-	-	-
Frissítés (Gyapjú frissítés)	Forró levegő befűvése nélkül 10 percig szellőztet. A programnak köszönhetően kiszellőztetheti a hosszú ideig zárt helyen tartott ruhákat, megszabadítva azokat a kellemetlen szagoktól. Használja ezt a programot mosógépben mosható gyapjú ruhanemű szellőztetéséhez és lágyításához. Ne használja teljes szárításhoz.	-	-	10
Finom textíliák / Ing	Ez sokkal érzékenyebben szárítja, és kevésbé gyűri meg az ingeket, így megkönnyíti a vasalást.	1,5	1200	50
Farmer	Ezzel a programmal farmernadrágokat, -szoknyákat, -ingeket vagy -kabátokat száríthat.	4	1200	140
Szabadidő / Sport (Goretex)	Szárítsa meg a szintetikus, pamut vagy vegyes textíliákból vagy vízálló anyagból készült ruháit, például funkcionális dzsekiket, esőkabátokat stb.. A szárítás előtt fordítsa ki őket.	2	1000	130
Vegyes(Napi)	Ezzel a programmal pamut és szintetikus ruhát is száríthat. Ezzel a programmal a sport- és fitness ruhákat száríthat.	4	1000	125

Higiéna (BabyProtect+)	Ez egy hosszú távú program, amely a higiéniai igénylő ruhákhoz (bébi ruhák, törülközők, fehérneműk, stb.) használatos, ahol magasabb higiénia van szükség. A higiéniai magas hőmérséklettel éri el ((Ezt a programot az angol "The British Foundation" (Allergy UK) azonosítja és hagyja jóvá.))	5	800	195
Toll	A szárítóban azokat a ruháit, például tollal és szállal bélelt kabátjait, dzsekijeit száríthatja, melyek címkéje engedélyezi a szárítóban történő szárítást. Kérjük, szárításkor fordítva!	-	800	100
Expressz 30'	Használja ezt a programot 2 ing vasalásra előkészítéséhez.	0,5	1200	30

Energiafogyasztási értékek

Programok	Kapacitás (kg)	A mosódob forgási sebessége (ford/perc)	Maradék nedvességtartalom kb.	Energiafogyasztási értékek kWh
Pamut Eko*	7	1000	60%	1,75
Pamut, vasalásra kész	7	1000	60%	1,40
Szintetikus, szekrényszárász	3,5	800	40%	0,65
	A teljes és részleges terhelés mellett használt "Pamut Eko program" egy szabványos szárítási program, a címkén és a lapon szereplő információk alapján ez a program alkalmas a normál nedves pamut ruhanemű szárítására, és ez a leghatékonyabb energiafogyasztású program a pamut ruhaneműk számára.			

* : Energy Label szabványos program (EN 61121: 2012) A táblázat összes értékét az EN 61121: 2012 szabvány határozza meg. Ezek az értékek a ruhanemű típusa, a centrifugálási sebesség, a környezeti viszonyok vagy a feszültségingadozás függvényében eltérhetnek a táblázatban megadott értékektől.



Az Allergy UK a British Allergy Association márkája. A „jóváhagyás pecsétjét” úgy alakították ki, hogy olyan emberek számára jelentsen iránymutatást, akik olyan

termékekre vonatkozó ajánlást követelnek meg, hogy a kapcsolódó termék az allergiás betegek környezetében korlátozza / csökkenti / megszünteti az allergéneket vagy csökkenti az allergén tartalmat. Célja annak biztosítása, hogy a termékeket tudományosan megvizsgálják vagy megvizsgálják oly módon, hogy mérhető eredményeket biztosítsanak.

5.5 Kiegészítő funkciók

Berregés / idő

A szárítógép a program végeztével hangjelzést bocsát ki. Ha nem akarja, hogy a jelzés hangos legyen, nyomja meg a „Berregés / idő” gombot. A Berregés / idő gomb megnyomásakor egy jelzőfény villan fel, és nem hallható hangjelzés a program befejeződésekor.



MEGJEGYZÉS

- Ez a funkció vagy a program elindulása előtt vagy az után aktiválható.

A Berregés / idő gomb segítségével állíthatja be a program időtartama alatt a Szárító rekesz/ Időszárító programokat.

Nedvesség szint gomb

A Nedvesség szint beállító gombot a nedvesség szintjének beállítására használhatja. A program ideje függ a választástól.



MEGJEGYZÉS

- Ezt a funkciót csak a program megkezdése előtt aktiválhatja.

Befejezési idő

Az idő vége funkció segítségével a program végének idejét akár 24 órával elhalaszthatja.

1. Nyissa ki a betöltőajtót és helyezze be a ruhaneműt.
2. Állítsa be a szárítási programot.
3. Nyomja meg Befejezés idejének kiválasztása gombot a kívánt késleltetés beállításához. A Befejezés idő LED világít. (Ha lenyomja és tartja a gombot, az Idő vége non-stop folyamatban lesz).
4. Nyomja le a Indítás/Bekapcsolva gombot. A Befejezési idő visszaszámlálása elindul. “:” A kijelzett késleltetett idő közepén található elválasztóvonal villog.



MEGJEGYZÉS

- Az idő lejártá előtt hozzáteheti és kiveheti a ruhaneműt. A kijelzett idő a normál szárítási idő és az Idő vége összege. A Befejezési idő LED a leszámolás végén kikapcsol, megkezdődik a szárítás és felvillan a szárítás LED.

Az Idő vége megváltoztatása

Amennyiben a visszaszámlálás alatt szeretné megváltoztatni a késleltetés idejét, akkor:

Törölje a programot a Be/Ki/Program kiválasztása gomb segítségével. Válassza ki a kívánt programot, majd ismétlje meg a Befejezési idő kiválasztása folyamatot. Idő vége funkció törlése

Amennyiben törölni szeretné az Idő vége funkciót és azonnal el szeretné indítani a programot:

Törölje a programot a Be/Ki/Program kiválasztása gomb segítségével. Válassza ki a kívánt programot, majd nyomja meg a Start/Készenlét gombot.

5.6 Figyelmeztető jelzések



MEGJEGYZÉS

- A figyelmeztető jelzések az adott szárítógép modelltől függően eltérőek lehetnek.

Bolyhszűrő tisztítása

A program végeztével bekapcsol a szűrőtisztítás figyelmeztető jelzés.

Víztartály

A program végeztével bekapcsol a víztartály leeresztése figyelmeztető jelzés.

Ha a víztartály a program közben telik meg, a figyelmeztető jelzés villogni kezd és a gép készenléti üzemmódba vált. Ebben az esetben engedje le a tartályt, majd a program elindításához nyomja meg az Indítás/Bekapcsolva gombot. A figyelmeztető szimbólum eltűnik és a program újra elindul.

Szűrőfiók / Hőcserélő tisztítása

Amikor a program befejeződik, a hőcserélő vagy a szűrőfiók tisztítását jelző fény világíthat.

5.7 A program indítása

A program elindításához nyomja meg az Indítás/Bekapcsolva gombot.

A Start / Készenléti és Száradási jelzőfények világítani fognak, jelezve, hogy a program elindult.

5.8 Gyerekzár

A szárítógép gyerekzárral rendelkezik annak érdekében, hogy a gombok lenyomásával ne lehessen megváltoztatni az aktuális programot. Amennyiben a gyerekzár aktív, a panelen lévő összes gomb, a Be/Ki/Programválasztás gombok kivételével inaktívvá válik.

A gyerekzár aktiválásához nyomja meg egyszerre a Nedvesség szint és a Berregés gombot, majd tartsa 3 másodpercig nyomva. A program végeztével új program elindításához, illetve a program megszakításához a gyerekzárát fel kell oldani. A gyerekzár feloldásához tartsa nyomva ugyanazokat a gombokat 3 másodpercen át.



MEGJEGYZÉS

- Ha a gyerekzár aktív, a kijelzőn bekapcsol a gyerekzár figyelmeztető jelzés.
- Ha a gépet be vagy kikapcsolja a Be/Ki/Törlés gombbal, a gyerekzár kikapcsol.



MEGJEGYZÉS

- Miközben a szárítógép működik és a gyerekzár aktív, kétszer sípol, amikor a programválasztó gombot elfordítja. Ha a gyerekzárát úgy kapcsolja ki, hogy a programválasztó gombot nem állítja vissza korábbi helyzetébe, a program a programválasztó gomb állásának módosítása miatt leáll.

5.9 A program módosítása indítás után

- A szárítógép elindítása után módosíthatja a kiválasztott a szárítási programot egy másik programra.
- Például, válassza az Extra száraz programot a Be/Ki/programválasztó gomb Vasalás-szárazból Extra száraz állásba való elfordításával.
- A program elindításához nyomja meg az Indítás/Bekapcsolva gombot.

Ruhanemű hozzáadása és eltávolítása bekapcsolt állapotban

- Ruhanemű hozzáadásához, illetve kivételéhez a szárítási program elindulását követően:
- A szárítógép készenléti üzemmódba állításához nyomja meg a Start/Készenlét gombot. A szárítási folyamat leáll.
- Nyissa ki a betöltőajtót Készenlét üzemmódban, töltsse be vagy vegye ki a ruhákat, majd csukja vissza az ajtót.
- A program elindításához nyomja meg az Indítás/Bekapcsolva gombot.



MEGJEGYZÉS

- A szárítás megkezdése után hozzáadott ruhanemű azt eredményezheti, hogy a gépben lévő, már megszáradt ruhák összekeverednek a vizes ruhákkal, így a szárítási folyamat végén a ruhanemű nedves marad.



MEGJEGYZÉS

- A ruhanemű hozzáadását és eltávolítását a szárítás ideje alatt akármennyiszor megismételheti. De ezzel többször megszakítja a szárítási folyamatot és növeli a programidőt és az energiafogyasztást is. A ruhanemű hozzáadása ezért a szárítási program elindulása előtt javasolt.
- Ha a berendezés készenléti állapotában a programválasztó gombbal új program választ, a folyamatban lévő program megszakad.



FIGYELMEZTETÉS!

- Ha a program futása közben adagol vagy vesz ki ruhát, a dob belső felszínét ne érintse meg. A dob felszíne ugyanis forró.

5.10 Program törlése

Ha bármilyen okból szeretné a szárítást leállítani és a programot törölni azután, hogy a gép elindult, nyomja meg a Be/Ki/Törlés gombot, és a program törődik.



FIGYELMEZTETÉS!

- Amennyiben a programot a berendezés működése közben állítja le, a berendezés belseje rendkívül forró lehet, ezért kapcsolja be a szellőztetés programot, hogy lehűtse.

5.11 Program vége

Ha a program véget ér, a Bolyhszűrő tisztítása és a Víztartály figyelmeztető jelzések kigyulladnak. A betöltőajtó kinyitható, és a gép készen áll a következő szárítási ciklusra. A szárítógép kikapcsolásához állítsa a Be/Ki/Programválasztás gombot Be/Ki állásba.



MEGJEGYZÉS

- Amennyiben a program végeztével nem üríti ki a ruhákat, a gyűrődés-megelőző funkció 2 órára aktívává válik, ezzel megakadályozva, hogy a gépben lévő ruhák összegyűrődjenek. A program 10 perces intervallumokban megforgatja a ruhákat, így megelőzve a gyűrődést.

6 Karbantartás és tisztítás

6.1 Betöltőajtó belső felület

A szárítási folyamat során kiválasztott haját, szőröket és szöszöket a szöszszűrő gyűjti össze.



MEGJEGYZÉS

- A szöszök a ruhák viselése és mosása során keletkeznek.
- A szűrő nyílását porszívóval tisztíthatja.



FIGYELMEZTETÉS!

- Minden szárítási ciklust követően tisztítsa ki a szöszszűrőt és a betöltő ajtó belső felületét.

A szöszszűrő tisztításához:

- Nyissa ki a betöltőajtót.
- Tartsa a két részes szöszszűrő első részét (a belső szűrőt), és vegye ki felfelé kihúzva azt.
- Kezével vagy puha ronggyal gyűjtse össze a szöszöket, bolyhokat és pamutgombócokat.
- Vegye ki a második részt (a külső szűrőt) felfelé kihúzva azt.

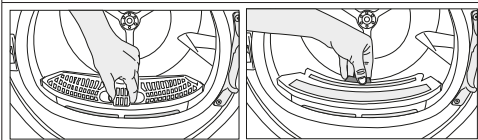

MEGJEGYZÉS

- Ugyeljen, hogy haj, szőrök, szöszök és pamutgombócok ne essenek a nyílásba, ahova a szűrőt kell behelyezni.
- Nyissa ki mindkét szöszszűrőt (a belső és a külső szűrőt), távolítsa el a haját, szöszöt, pamutgombócokat nedves kézzel vagy porszívóval vagy egy ruhával.

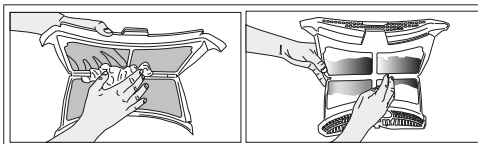

- Tisztítsa meg mindkét szűrőt folyóvíz alatt, a szösz felgyűlésével ellentétes irányban, vagy egy puha kefe használatával. Szárítsa meg a szűrőt, mielőtt visszahelyezné.

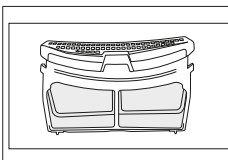
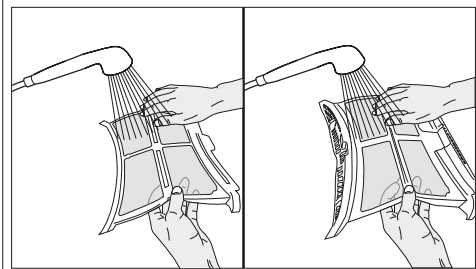

- Helyezze a két szöszszűrőt egymásra, és helyezze vissza azokat a helyükre.

- Tisztítsa meg a betöltő ajtó belsejét és az alátétet nedves puha ruhával.

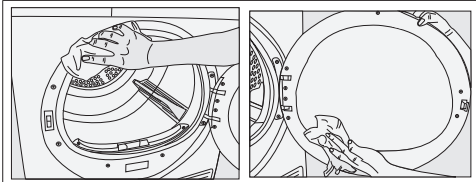

6.2 Az érzékelők tisztítása

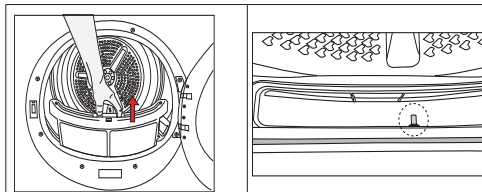

- A szárítóban hőmérséklet-érzékelő található, amely megállapítja, hogy a ruhanemű száraz vagy sem.

Az érzékelők tisztítása:

- Nyissa ki a szárító betöltési ajtaját.
- A szőszszűrő eltávolításához húzza ki azt.
- Tisztítsa meg az érzékelőt a kezével, ha a bolyhok felhalmozódnak rajta.

Amennyiben a víztartályt elfelejti leereszteni, a gép a következő szárítási ciklusok során, amikor a víztartály teli van, leáll, a Víztartály telítettségét jelző fény pedig villog. Amennyiben ez az eset áll elő, eressze le a víztartályt, majd nyomja meg a Start / Pause gombot, a szárítási ciklus folytatásához.

A víztartály leeresztéséhez:

1. Óvatosan emelje ki a víztartályt a fiókból vagy a tartályból.

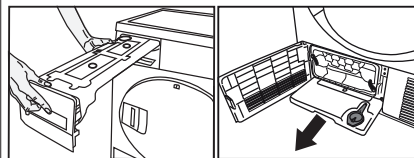

2. Öntse ki a vizet a tartályból.

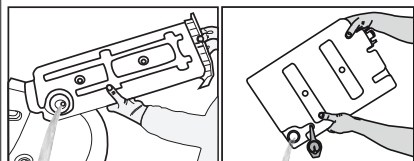

- Amennyiben a víztartály tölcserében szőszök gyűltek fel, folyó víz alatt tisztítsa meg azt.
- Helyezze vissza a víztartályt.



MEGJEGYZÉS

- Tisztítsa évente 4 alkalommal a szenzorok fém felületeit.
- A szenzorok fém felületeinek tisztítása során ne használjon fém eszközöket.
- Várja meg, amíg a gép lehűl, ha az még meleg a szárítást követően.



FIGYELMEZTETÉS!

- A tisztítás során soha ne használjon oldószereket, tisztítószereket és hasonló anyagokat, tűz- és robbanásveszély miatt!



MEGJEGYZÉS

- Amennyiben lehetősége van közvetlen vízleeresztésre, nem szükséges ürítenie a víztartályt.

6.4 A párologtató tisztítása

Azok a szőrök és szőszök, amit a szőszszűrő nem fog fel, a párologtató lamellái közé kerülnek, a biztonsági rács mögött, és ott gyűlnek össze. Tisztítsa ki a párologtatót negyedévenként, vagy amikor a párologtató " " ikon villogó jelzést ad.

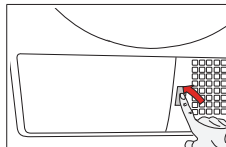

- Nyissa ki a biztonsági rácsot annak megnyomásával.

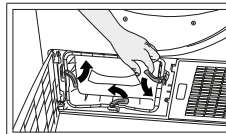

- A légtelítő ajtó megnyitásához mozgassa az oldó reteszt.

6.3 A víztartály leeresztése

A szárítási folyamat során a ruhákban lévő nedvességet a gép eltávolítja és kondenzálja, a meglévő víz a víztartályban gyűlik össze. Minden szárítási ciklus után engedje le a vizet.



FIGYELMEZTETÉS!

- A kondenzvíz nem iható!
- Program közben soha ne távolítsa el a víztartályt!

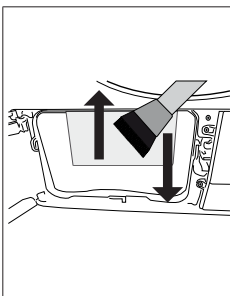

- Távolítsa el a párologtatóról a szőszöket nedves ruhával vagy porszívóval kefék előtét alkalmazásával, a porszívófej fel- és lefelé való mozgatásával.

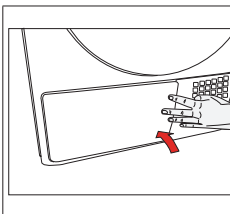

- A tisztítás elvégzését követően helyezze a légtérelő aajtáját a helyére, zárja a reteszt, és zárja vissza a biztonsági rácsot.



FIGYELMEZTETÉS!

- A tisztítást kézzel is végezheti, amennyiben védőkesztyűt visel. Ne próbálja meg csupasz kézzel végezni a tisztítást. A párologtató lamellái megsérthetik a kezét.
- A balról jobbra való mozdulattal végzett tisztítás kárt okozhat a párologtató lamelláiban. Ez szárítási problémákat eredményezhet.

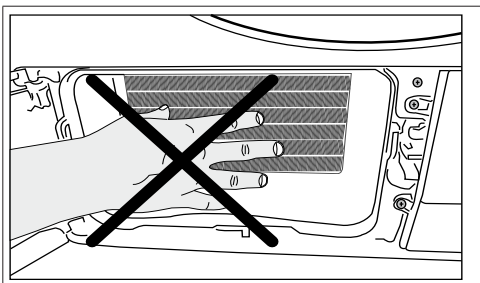

7 Hibaelhárítás

A szárítási művelet túl hosszán tart.
Szösszszűrő (belső és külső szűrő) pórusai eltömődhetnek. >>> Mossa ki a szösszszűrőket meleg vízzel, és szárítsa meg. A párologtató elülső oldala eltömődhetett. >>> Tisztítsa meg a párologtató elülső oldalát. A gép elején található szellőzőrácsok zárva lehetnek. >>> Távolítsa el minden tárgyat a szellőzőrács elől, ami akadályozhatja a levegő útját. Lehetséges, hogy a szellőzés nem megfelelő, ugyanis a hely, ahová a gépet beszerelték, túl kicsi. >>> Nyissa ki az ajtót vagy az ablakokat, hogy megakadályozza, hogy a hőmérséklet túl magasra emelkedjen a helyiségben. A nedvesség-érzékelőn vízköréteg rakódhatott le. >>> Tisztítsa meg a nedvesség érzékelőt. Lehet, hogy túl sok ruhát töltött be. >>> Ne töltse túl a szárítógépet. Lehet, hogy a ruhák nincsenek megfelelően kicentrifugázva. >>> Kapcsolja nagyobb fordulatszámra a centrifugát a mosógépen.
A ruhák a szárítást követően is nedvesek.
Lehetséges, hogy nem a ruhatípusnak megfelelő programot használt.>>> Ellenőrizze a ruhák kezelésre vonatkozó címkéit, majd válasszon a ruhatípusnak megfelelő programot, vagy kiegészítésként használjon más időprogramot. Szösszszűrő (belső és külső szűrő) pórusai eltömődhetnek. >>> Mossa ki a szűrőket meleg vízzel, és szárítsa meg. A párologtató elülső oldala eltömődhetett. >>> Tisztítsa meg a párologtató elülső oldalát. Lehet, hogy túl sok ruhát töltött be. >>> Ne töltse túl a szárítógépet. Lehet, hogy a ruhák nincsenek megfelelően kicentrifugázva. >>> Kapcsolja nagyobb fordulatszámra a centrifugát a mosógépen.
A szárítógép nem kapcsol be, vagy a program nem indul el. A szárítógép nem működik a konfigurálást követően.
Lehetséges, hogy a kábel ki van húzva. >>> Ellenőrizze, hogy a tápkábel be van-e dugva. A betöltőajtó félig nyitva van. >>> Győződjön meg róla, hogy a betöltőajtó biztosan be van-e zárva. A programot nem lehet beállítani, vagy a Start/Szünet/Töröl gombot nem lehet megnyomni. >>> Ellenőrizze, hogy a programot beállította-e, és nem Szünet módban van. Lehetséges, hogy a gyerekkár aktiv. >>> Kapcsolja ki a gyerekkárát.

A program idő előtt ok nélkül megszakadt.
Lehetséges, hogy a betöltőajtó teljesen be van csukva. >>> Győződjön meg róla, hogy a betöltőajtó biztosan be van-e zárva. Lehetséges, hogy áramkimaradás van. >>> A program elindításához nyomja meg az Indítás/Szünet/Törés gombot. Lehet, hogy a víztartály megtelt. >>> Eressze le a víztartályt.
A ruhák összemertek, megkeményedtek vagy tönkrementek.
Lehetséges, hogy nem az adott ruháknak megfelelő programot használt. >>> Ellenőrizze a ruhán található címkét, és az anyagnak megfelelő programot válasszon.
A betöltőajtón víz csepeg.
Lehetséges, hogy a betöltőajtó belső oldalán és a betöltőajtó tömítésén szálak gyűltek fel. >>> Tisztítsa meg a betöltőajtó belső felületét és az ajtó tömítéseit.
A betöltőajtó magától kinyílik.
Lehetséges, hogy a betöltőajtó teljesen be van csukva. >>> Tolja be a betöltőajtót, amíg a becsukódást jelző hangot nem hallja.
A Víztartály figyelmeztető jelzés világít/villog.
Lehet, hogy a víztartály megtelt. >>> Eressze le a víztartályt. Lehetséges, hogy a vízleeresztő tömlő tönkrement. >>> Ha a készülék közvetlenül csatlakozik a vízleeresztőhöz, ellenőrizze a tömlőt.
A szárítógépen belüli világítás nem kapcsol fel. (Lámpával ellátott modellek esetén)
Lehet, hogy a szárítógépet nem kapcsolták be a Be/Ki gombbal. >>> Győződjön meg róla, hogy a szárítógépet bekapcsolta. Lehetséges, hogy a lámpa meghibásodott. >>> A lámpa cseréje érdekében vegye fel a kapcsolatot a Hivatalos Szervizzel.
A gyűrődésmentes ikon világít.
A ruhák gyűrődését megakadályozó gyűrődésmentes üzemmód aktiválva lehet. >>> Kapcsolja ki a szárítót és vegye ki a ruhákat.
A szösszszűrő tisztítására figyelmeztető ikon világít.
Szösszszűrő (belső és külső szűrő) szennyezett lehet. >>> Mossa ki a szűrőket meleg vízzel, és szárítsa meg. A szösszszűrő pórusain lepedék képződhetett, ami eltömődést okoz. >>> Mossa ki a szűrőket meleg vízzel, és szárítsa meg. Lehet, hogy a szösszszűrők nincsenek behelyezve. >>> Helyezze be a belső és a külső szűrőt a helyére.

Figyelmeztető hangjelzést ad a gép

Lehet, hogy a szöszszűrők nincsenek behelyezve.
>>> Helyezze be a belső és a külső szűrőt a helyére.

A párologtató figyelmeztető ikonja villog.

A párologtató elülső oldala szöszszel eltömődhetett. >>> Tisztítsa meg a párologtató elülső oldalát.
Lehet, hogy a szöszszűrők nincsenek behelyezve.
>>> Helyezze be a belső és a külső szűrőt a helyére.

A szárítógépen belüli világítás felkapcsol. (Lámpával ellátott modellek esetén)

Ha a szárítógép a hálózatra van csatlakoztatva, a Be/Ki kapcsolót megnyomják, és az ajtó nyitva van, akkor a világítás felkapcsolódik. >>> Húzza ki a hálózati csatlakozót, vagy állítsa a Be/Ki kapcsolót "Ki" állásba.



FIGYELMEZTETÉS!

- Amennyiben a probléma a jelen fejezetben közölt útmutatások követése után is fennáll, vegye fel a kapcsolatot eladójával vagy a Hivatalos szervizzel. Soha ne próbálja egyedül megjavítani a készüléket.



MEGJEGYZÉS

- Amennyiben a berendezés bármely alkatrészét illetően problémával találkozik, a hivatalos szerviztől kérheti annak cseréjét, megadva a készülék modellszámát.
- Amennyiben a berendezést nem eredeti alkatrészekkel használja, az hibás működést eredményezhet.
- A gyártót és a forgalmazót semmilyen felelősség nem terheli a nem eredeti alkatrészekkel történő használatból eredő hibákért.

TERMÉKISMERTETŐ ADATLAP

Megfelel a Bizottság 392/2012 sz. (EU) felhatalmazáson alapuló rendeletének

A forgalmazó neve vagy márkája		BEKO
A típus neve		DF7412PA 7188301400
Névleges kapacitás (kg)		7.0
Forgódobos szárítógép típus	Légbefűvős	-
	Kondenzátor	•
Energiahatékonysági osztály ⁽¹⁾		A++
Éves energiafelhasználás (kWh) ⁽²⁾		212,0
Vezérlés típusa	Automatikus	•
	Nem-automatikus	-
Energiafelhasználás teljes töltetű normál pamutprogram esetén (kWh)		1,75
Energiafelhasználás féltöltetű normál pamutprogram esetén (kWh)		0,96
Energiafogyasztás kikapcsolt üzemmódban teljes töltetű normál pamutprogramhoz, P_0 (W)		0,50
Energiafogyasztás kikapcsolt üzemmódban teljes töltetű normál pamutprogramhoz, P_L (W)		1,00
A bekapcsolva hagyott üzemmód időtartama (perc)		30
Normál pamut program ⁽³⁾		•
A teljes töltetű normál pamutprogram programideje $T_{szárz}$ (perc)		179
A részleges töltetű normál pamutprogram programideje, $T_{szárz\ 1/2}$ (perc)		107
A teljes és részleges töltetű normál pamutprogram súlyozott programideje (T_s)		138
Kondenzációhatékonysági osztály ⁽⁴⁾		B
Átlagos kondenzáció hatékonyság standard pamut program esetén, teljes adag, C_{gy}		81%
Átlagos kondenzáció hatékonyság standard pamut program esetén, részleges adag, $C_{gy1/2}$		81%
A teljes és féltöltetű normál pamutprogram súlyozott kondenzációhatékonysági osztálya, C_t		81%
A teljes töltetű normál pamutprogram hangteljesítményszintje ⁽⁵⁾		65
Beépített		-

• : Igen - : Nem

(1) A+++-tól (leghatékonyabb) D-ig (legkevésbé hatékony) terjedő skála

(2) Az energiafelhasználás 160 teljes és részleges töltetű normál pamutprogram szárítási ciklusán alapul, alacsony energiaszintű teljesítmény fokozaton. Az aktuális energiafelhasználás/ciklus a készülék alkalmazási módjától függ.

(3) "A teljes és a részleges töltet melletti „Szekrényszáraz pamutprogram” az a normál nedves pamut ruhanemű szárítására alkalmas standard szárítóprogram, amelyre a címkén és a termékmertető adatlapon megadott adatok vonatkoznak, és amely a pamut ruhanemű esetében az energiafogyasztás szempontjából a leghatékonyabb.

(4) G-től (legkevésbé hatékony) A-ig (leghatékonyabb) terjedő skála

(5) Súlyozott átlagos érték — L_{WA} B(A)-ban kifejezve 1 pW-ra vonatkoztatva

Vă rugăm să citiți mai întâi acest manual de utilizare!

Stimate client,

Vă mulțumim pentru alegerea produselor Beko. Sperăm că produsul nostru, fabricat la standarde de înaltă calitate și tehnologie, vă va oferi cele mai bune rezultate. Vă recomandăm să citiți cu atenție acest manual și alte documentații suplimentare înainte de a utiliza produsul dumneavoastră și să le păstrați pentru referințe ulterioare. Dacă oferiți acest produs altei persoane, oferiți-i și manualul aferent. Acordați atenție tuturor detaliilor și avertismentelor specificate în manualul de utilizare și respectați instrucțiunile prezentate în acesta.

Utilizați manualul de utilizare pentru modelul indicat pe copertă.



- Citiți instrucțiunile.

Explicația simbolurilor

Următoarele simboluri sunt utilizate în cuprinsul acestui manual de utilizare:



PERICOL!

- Avertisment împotriva electrocutării.



PERICOL!

- Avertisment împotriva pericolului de incendiu.



AVERTISMENT!

- Avertismente privind situații periculoase pentru viață și proprietate.



AVERTISMENT!

- Avertisment împotriva suprafețelor fierbinți.



AVERTISMENT!

- Avertizare privind riscul de arsuri



REȚINEȚI

- Informații importante sau sfaturi utile despre utilizare.



- Ambalajele produsului sunt fabricate din materiale reciclabile în conformitate cu Reglementările naționale privind mediul.

Nu eliminați deșeurile de ambalaje împreună cu deșeurile menajere sau alte deșeuri, eliminați-le la punctele de colectare speciale, desemnate de autoritățile locale.



1 Instrucțiuni importante de securitate și mediu



REȚINEȚI

- Această secțiune conține instrucțiuni de securitate care vă vor ajuta la protecția împotriva riscului de rănire sau deteriorarea a proprietății. Nerespectarea acestor instrucțiuni va anula orice garanție.

1.1 Informații generale privind securitatea



AVERTISMENT!

- Acest echipament poate fi utilizat de copii cu vârsta de peste 8 ani și persoane cu capacitate fizică, senzorială sau mentală redusă sau care nu au experiență și nu sunt familiarizate cu echipamentul dacă acestea sunt supravegheate sau li se oferă instrucțiuni privind utilizarea echipamentului într-o manieră sigură și înțeleg pericolele implicate. Copiii nu trebuie să se joace cu echipamentul. Curățarea și operațiunile de întreținere realizate de utilizator nu vor fi realizate de copii nesupravegheați.
- Nu permiteți copiilor cu vârsta sub 3 ani accesul la aparat cu excepția cazului în care sunt în permanent supravegheați.
- Picioarele reglabile nu trebuie îndepărtate. Spațiul liber dintre uscător și podea nu trebuie redus cu materiale precum covoare, lemn sau bandă. Acest lucru cauzează probleme în funcționarea uscătorului.



AVERTISMENT!

- Instalarea și procedurile de reparare trebuie efectuate întotdeauna de către Personalul autorizat de service. Producătorul nu va fi răspunzător pentru daunele care pot apărea din efectuarea procedurilor de către persoane neautorizate.
- Nu spălați niciodată uscătorul prin pulverizarea sau picurarea apei pe echipament! Există pericol de electrocutare!

1.1.1 Securitatea electrică



PERICOL!

- **Securitatea electrică**
Instrucțiunile privind securitatea electrică trebuie respectate în timpul efectuării racordării la rețeaua electrică în momentul instalării.
- **Aparatul nu trebuie alimentat printr-un dispozitiv de conectare, cum ar fi un comutator temporizat, sau conectat la un circuit care este activat sau dezactivat regulat de serviciul public utilitar.**
- Conectați uscătorul la o priză cu împământare protejată de o siguranță la valoarea specificată pe etichetă. Instalarea împământării trebuie efectuată de către un electrician calificat. Societatea noastră nu va fi răspunzătoare pentru nicio daună care poate apărea în momentul în care uscătorul este utilizat fără împământare, în conformitate cu regulamentele locale.



PERICOL!

- Tensiunea și protecția permisă a siguranței sunt specificate pe etichetă.
- Tensiunea specificată pe etichetă trebuie să fie egală cu tensiunea sursei dumneavoastră principale de alimentare. Scoateți uscătorul din priză când nu îl utilizați.
- Deconectați uscătorul de la sursa principală de alimentare în timpul instalării, operațiunilor de întreținere, curățare și reparație.
- Nu atingeți priza dacă aveți mâinile umede! Nu deconectați niciodată aparatul prin smulgerea cablului, întotdeauna prindeți de fișă atunci când scoateți cablul.
- Nu utilizați prelungitoare, blocuri multipriză sau adaptoare pentru conectarea uscătorului la sursa de alimentare, pentru a permite scăderea riscului de incendiu sau de electrocutare.
- Fișa cablului de alimentare trebuie să fie ușor accesibilă după instalare.
- **Cablul principal deteriorat trebuie înlocuit, notificând Personalul autorizat de service.**
- **Dacă uscătorul este defect, acesta nu trebuie utilizat decât dacă a fost reparat de către un agent autorizat de service!
Există pericol de electrocutare!**

1.1.2 Securitatea produsului



AVERTISMENT!

- Asigurați-vă că admisia de aer a uscătorului este deschisă și bine ventilată.
- Produsul conține agent frigorific R290.
- Produsul conține agent frigorific R290.
- Țineți produsul departe de posibile surse de căldură care pot provoca aprinderea.



PERICOL!

- **Puncte de luat în considerare în cazul pericolului de incendiu:**

Următoarele tipuri de rufe sau articole nu trebuie uscate în uscător, având în vedere pericolul de incendiu.

- Rufe nespălate
- Articolele pătate cu ulei, acetonă, alcool, păcură, cherosen, soluții de îndepărtare a petelor, terebentină, parafină sau soluții de îndepărtare a parafinei, trebuie spălate în apă caldă cu mult detergent înainte de a fi uscate în uscător.

Din acest motiv, în special articolele care prezintă petele specificate anterior trebuie spălate foarte bine, iar pentru acest lucru trebuie să utilizați detergentul adecvat și să selectați o temperatură ridicată de spălare.

- **Următoarele rufe sau articole specificate nu trebuie uscate în uscător din cauza pericolului de incendiu:**



PERICOL!

- Articole de îmbrăcăminte sau perne întărite cu spumă de cauciuc (spumă latex), bonete de duș, materiale textile rezistente la apă, materiale cu întăritură din cauciuc și pernțe din spumă de cauciuc.
- Articole de îmbrăcăminte curățate cu substanțe chimice industriale.
- Articole precum brichete, chibrite, monede, piese din metal, ace, etc. pot deteriora ansamblul tamburului sau pot duce la probleme de funcționare. De aceea, verificați toate rufele spălate pe care le încărcăți în uscătorul dumneavoastră.
- Nu opriți niciodată uscătorul înainte de finalizarea programului. Dacă trebuie să faceți acest lucru, îndepărtați rapid toate rufele spălate și întindeți-le pentru a elimina căldura.
- Articolele de îmbrăcăminte care au fost spălate neadecvat se pot autoaprinde, chiar și după finalizarea procesului de uscare.
- Trebuie să furnizați o ventilație suficientă pentru a preveni acumularea în cameră a gazelor emise de dispozitivele care funcționează cu alte tipuri de combustibil, inclusiv flacăra deschisă, din cauza efectului de aprindere inversă.



AVERTISMENT!

- Lenjeria care conține întărituri din metal nu trebuie uscată în uscător. Uscătorul se poate deteriora dacă întăriturile din metal se slăbesc și se rup în timpul procesului de uscare.



REȚINEȚI

- Utilizați balsamuri de rufe și produse similare în conformitate cu instrucțiunile producătorilor acestora.
- Întotdeauna curățați filtrul de scame înainte sau după fiecare încărcare. Nu operați niciodată uscătorul fără a avea filtrul de scame instalat.



AVERTISMENT!

- Nu încercați niciodată să reparați dumneavoastră uscătorul. Nu efectuați nicio reparație sau procedură de înlocuire pe produs chiar dacă știți sau aveți capacitatea de a efectua procedurile necesare, doar dacă se specifică clar acest lucru în instrucțiunile de funcționare sau în manualul de service publicat. Altfel, vă puneți viața dumneavoastră și a celorlalți în pericol.
- Nu trebuie să existe nicio ușă blocabilă, culisantă sau batantă care ar putea bloca deschiderea ușii de încărcare în locația în care uscătorul dumneavoastră va fi instalat.
- Instalați uscătorul dumneavoastră în locații adecvate pentru utilizare casnică. (Baie, balcon închis, garaj, etc.)



AVERTISMENT!

- Asigurați-vă că animalele de casă nu intră în uscător. Verificați interiorul uscătorului înainte de a-l porni.
- Nu vă aplecați pe ușa de încărcare a uscătorului dumneavoastră atunci când este deschisă; aceasta ar putea cădea.
- Nu se va permite acumularea scamelor în jurul uscătorului.

1.2 Montajul pe o mașină de spălat

- Se va utiliza un dispozitiv de fixare între cele două mașini în momentul instalării uscătorului peste o mașină de spălat. Dispozitivul de fixare trebuie instalat de către un agent autorizat de service.
- Greutatea totală a mașinii de spălat și a uscătorului - în sarcină completă - în locația în care sunt montate una peste alta trebuie să atingă aproximativ 180 de kilograme. Așezați produsele pe o suprafață solidă care are o capacitate suficientă de susținere a sarcinii!



AVERTISMENT!

- Mașina de spălat nu poate fi așezată pe uscător. Acordați atenție avertismentelor anterioare în timpul instalării pe mașina dumneavoastră de spălat.

Masa de instalare pentru mașina de spălat și uscător

Adâncimea uscătorului	Adâncimea mașinii de spălat			
	62 cm	60 cm	54 cm	< 50 cm
54 cm	Poate fi instalat.		Nu poate fi instalat.	
60 cm	Poate fi instalat.	Nu poate fi instalat.		

1.3 Domeniul de utilizare

- Uscătorul este conceput pentru utilizare casnică. Nu este adecvat pentru utilizare comercială și nu trebuie utilizat în alte scopuri decât utilizarea recomandată.
- Utilizați uscătorul doar pentru uscarea rufelor marcate special în acest sens.
- Producătorul nu își asumă nicio răspundere care poate apărea din utilizarea sau transportul incorect.
- Durata de funcționare a uscătorului pe care l-ați achiziționat este de 10 ani. În timpul acestei perioade, piesele de schimb originale vor fi disponibile pentru funcționarea adecvată a uscătorului.

1.4 Siguranța copiilor

- Ambalajele sunt periculoase pentru copii. Nu lăsați ambalajele la îndemâna copiilor. Produsele electrice sunt periculoase pentru copii. Nu lăsați copii în apropierea produsului care este în funcțiune. Nu permiteți copiilor să umble la uscător. Utilizați un sistem de închidere securizat pentru copii pentru a-i împiedica să umble la uscător.



REȚINEȚI

- Sistemul de închidere securizat pentru copii se află pe panoul de control. (Consultați secțiunea Sistem de închidere securizat pentru copii)
- Mențineți ușa de încărcare închisă chiar și atunci când uscătorul nu este în funcțiune.

1.5 Conformitate cu Directiva WEEE și depozitarea la deșeurile a produsului uzat:



Acest produs respectă Directiva UE WEEE (2012/19/UE). Produsul este marcat cu un simbol de clasificare pentru deșeurile electrice și electronice (WEEE).

Acest produs a fost fabricat

folosind piese și materiale de înaltă calitate, care pot fi reutilizate și reciclate. Nu depozitați produsul uzat împreună cu gunoierul menajer la sfârșitul duratei sale de funcționare. Duceți-l la un centru de colectare pentru reciclarea echipamentelor electrice și electronice. Luați legătura cu autoritățile locale pentru a afla informații despre aceste centre de colectare.

1.8 Specificații tehnice

RO

Înălțime (Min. / Max.)	84,6 cm / 86,6 cm*
Lățime	59,7 cm
Adâncime	50,8 cm
Capacitate (max.)	7 kg**
Greutate netă (± %10)	40 kg
Tensiune	Consultați eticheta***.
Putere nominală de intrare	
Cod model	

* Înălțime min.: Înălțimea cu picioarele reglabile închise.

Înălțime max.: Înălțimea cu picioarele reglabile deschise la nivelul maxim.

**Greutatea rufelor uscate înainte de spălare.

*** Eticheta cu tipul aparatului se află în spatele ușii de încărcare.

	REȚINEȚI
<ul style="list-style-type: none">• Specificațiile tehnice ale uscătorului sunt supuse modificărilor fără o notificare prealabilă pentru a îmbunătăți calitatea produsului.• Imaginile din acest manual de utilizare sunt schematic și pot să nu corespundă exact produsului dumneavoastră.• Valorile specificate pe marcasele de pe uscător sau din alte documentații publicate care însoțesc uscătorul sunt obținute în laborator în conformitate cu standardele relevante. Aceste valori pot varia în funcție de condițiile de operare și de mediu ale uscătorului.	



PERICOL!

- R290 este un agent frigorific inflamabil. Astfel, asigurați-vă că sistemul și țevile nu sunt avariate în timpul operării și manevrării.
- Țineți produsul departe de posibile surse de căldură care pot provoca aprinderea în caz de avarii.
- Nu casați produsul dându-i foc.

1.6 Conformitate cu Directiva RoHS:

Produsul pe care l-ați achiziționat respectă Directiva UE RoHS (2011/65/UE). Nu conține materiale dăunătoare și interzise specificate în Directivă.

1.7 Informații despre ambalaj

Ambalajul produsului este produs din materiale reciclabile, conform reglementărilor noastre naționale de mediu. Nu depozitați ambalajul împreună cu gunoierul menajer sau cu alte deșeurile. Depozitați-l în punctele de colectare a ambalajelor amenajate de autoritățile locale.

2 Uscătorul dumneavoastră

2.1 Prezentare generală

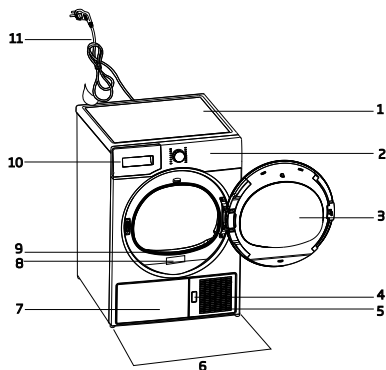

1. Panoul superior
2. Panoul de comandă
3. Ușa de încărcare
4. Butonul de deschidere a plăcii de protecție
5. Grătare de ventilare
6. Picioare reglabile
7. Placa de protecție
8. Eticheta
9. Filtru de scame
10. Sertarul rezervorului de apă
11. Cablul de alimentare

2.2 Conținutul ambalajului

	1. Furtun pentru scurgerea apei*		5. Manual de utilizare al tamburului de uscare*
	2. Burete de schimb pentru sertarul filtrului*		6. Recipientul de umplere cu apă*
	3. Manual de utilizare		7. Apă pură*
	4. Tambur de uscare*		8. Unitatea pentru pastile de parfum*

*Poate fi furnizată împreună cu mașina dumneavoastră în funcție de modelul acesteia.

3 Instalare

Înainte de a telefona celui mai apropiat Centru de service pentru instalarea uscătorului, asigurați-vă că instalația electrică și rețeaua de scurgere a apei sunt corespunzătoare conform manualului de utilizare. Dacă acestea nu sunt adecvate, contactați un electrician și un tehnician calificat pentru a realiza modificările necesare.



REȚINEȚI

- Clientul este răspunzător pentru pregătirea locației uscătorului, precum și pentru instalațiile electrice și de scurgere a apei menajere.



AVERTISMENT!

- Înainte de instalare, verificați vizual dacă uscătorul are defecte. Dacă uscătorul este deteriorat, acesta nu trebuie instalat. Produsele deteriorate cauzează riscuri asupra securității dumneavoastră.
- Așteptați 12 ore înainte de a porni uscătorul pentru utilizare.

3.1 Locația potrivită pentru instalare

Instalați uscătorul pe o suprafață stabilă și plană.

Uscătorul este greu. Nu mutați uscătorul singuri.

- Utilizați uscătorul într-un mediu bine ventilat și fără praf.
- Spațiul liber dintre uscător și podea nu trebuie redus cu materiale precum covoare, lemn sau bandă.
- Nu acoperiți grătarele de ventilare ale uscătorului.
- Nu trebuie să existe nicio ușă blocabilă, culisantă sau batantă care ar putea bloca deschiderea ușii de încărcare în locația în care uscătorul dumneavoastră va fi instalat.
- După instalarea uscătorului, acesta trebuie să rămână în același loc în care s-au realizat racordurile. La instalarea uscătorului, asigurați-vă că peretele din spate al acestuia nu atinge nimic (robinet, priză, etc.).
- Așezați uscătorul la cel puțin 1 cm de

marginile altor corpuri de mobilier.

- Uscătorul dumneavoastră poate funcționa la temperaturi între +5°C și +35°C. În cazul în care condițiile de funcționare nu sunt cuprinse în acest interval, funcționarea uscătorului poate fi afectată și acesta se poate deteriora.
- Suprafața din spate a uscătorului va fi așezată pe un perete.



PERICOL!

- Nu așezați uscătorul pe cablul de alimentare.

*** Ignorați următorul avertisment dacă sistemul produsului dvs. nu conține R290**



PERICOL!

- Uscătorul conține agent frigorific R290.*
- R290 este un agent frigorific prietenos cu mediul, dar inflamabil.*
- Asigurați-vă că admisia de aer a uscătorului este deschisă și bine ventilată.*
- Asigurați-vă că admisia de aer a uscătorului este deschisă și bine ventilată.*

3.2 Îndepărtarea ansamblului de securitate în transport



AVERTISMENT!

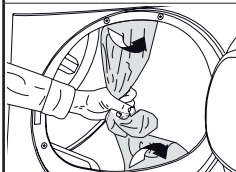

Îndepărtați ansamblul de securitate în transport înainte de a utiliza uscătorul pentru prima dată.

3.3 Racordarea la rețeaua de scurgere

Puteți scurge apa acumulată direct prin furtunul de scurgere a apei furnizat cu produsul, în locul scurgerii periodice a apei colectate în rezervor.

Racordarea furtunului de scurgere a apei

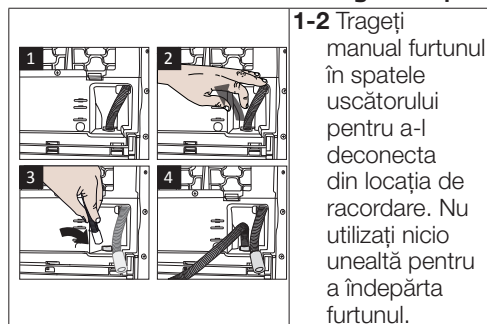

1-2 Trageți manual furtunul în spatele uscătorului pentru a-l deconecta din locația de racordare. Nu utilizați nicio unealtă pentru a îndepărta furtunul.

3 Conectați un capăt al furtunului de scurgere furnizat cu uscătorul la punctul de racordare de unde ați îndepărtat furtunul produsului în pasul anterior.

4 Conectați capătul celălalt al furtunului de scurgere direct la rețeaua de scurgere a apei menajere sau la chiuvetă.

i REȚINEȚI

- Furtunul de scurgere a apei trebuie atașat la o înălțime de maxim 80 cm.
- Asigurați-vă că furtunul de scurgere a apei nu este călcat și nu are pliuri între rețeaua de scurgere și mașină.
- Dacă împreună cu produsul vi s-a furnizat și un pachet cu accesorii, vă rugăm să citiți descrierea detaliată.

3.4 Reglarea picioarelor

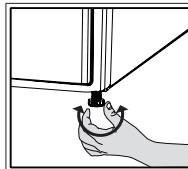

- Rotiți picioarele către stânga sau dreapta până ce uscătorul este așezat la nivel și fix.

3.5 Transportul uscătorului

Scoateți uscătorul din priză înainte de a-l transporta.

Surgeți toată apa care a rămas în uscător. Dacă s-a realizat o racordare directă la rețeaua de scurgere a apei, atunci îndepărtați racordurile furtunului



AVERTISMENT!

- Recomandăm să transportați uscătorul în poziție dreaptă. Dacă nu este posibil acest lucru, vă recomandăm transportul acestuia prin înclinarea mașinii către partea dreaptă, privind mașina din față.

3.6 Avertismente privind sunetele



REȚINEȚI

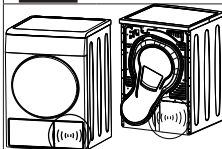

- Este normal să auziți uneori un zgomot metallic din compresor în timpul funcționării.
- Apa colectată în timpul funcționării este pompată către rezervorul de apă. Este normal să auziți zgomotul de pompare în timpul procesului.

3.7 Înlocuirea lămpii de iluminare

În cazul utilizării unei lămpi de iluminare în uscătorul dumneavoastră
Pentru a înlocui becul/LED-ul utilizat pentru iluminare în uscătorul dumneavoastră, apelați la Centrul autorizat de service local.
Lampa (lămpile) utilizate în acest aparat nu este (sunt) corespunzătoare pentru iluminarea unei camere. Scopul recomandat al acestei lămpi este de a asista utilizatorul în așezarea rufelor în uscător într-un mod confortabil. "Becurile folosite în acest aparat trebuie să reziste la condiții fizice extreme precum vibrațiile și temperaturile de peste 50 °C."

4 Pregătirea

4.1 Rufe corespunzătoare pentru uscarea în uscător

Urmați întotdeauna instrucțiunile oferite pe etichetele vestimentare. Uscăți la uscător doar rufe care au o etichetă care le indică ca fiind potrivite pentru uscare în uscător.

4.2 Rufe necorespunzătoare pentru uscarea în uscător



Articolele cu acest simbol nu trebuie uscate în Uscător.



REȚINEȚI

- Materialele brodate delicate, lâna, articolele din mătase, materialele delicate și fine, articolele ermetice și perdelele din tul nu sunt corespunzătoare pentru uscător.

4.3 Pregătirea rufelor pentru uscare

- Rufe pot fi încălcite după spălare. Separați articolele înainte de a le așeza în uscător.
- Uscăți articolele care au accesorii din metal, precum fermoare, pe dos.
- Închideți fermoarele, cărligele și cataramele și butonii.

4.4 Modalități de reducere a consumului de energie electrică

- Informațiile următoare vă vor ajuta să utilizați uscătorul într-o manieră ecologică și eficientă din punct de vedere al energiei electrice.
- Stoarceți rufe la viteza cea mai mare posibilă în momentul în care le spălați. Astfel, timpul de uscare este redus, iar consumul de energie electrică este redus.
- Sortați rufe în funcție de tipul și grosimea acestora. Uscăți același tip de rufe împreună. De exemplu, prosoapele de bucătărie subțiri și fețele de masă se usucă mai rapid decât prosoapele de baie.
- Urmați instrucțiunile din manualul de utilizare pentru selectarea programelor.
- Nu deschideți ușa de încărcare a mașinii în timpul procesului de uscare decât dacă este necesar. Dacă trebuie neapărat

să deschideți ușa de încărcare, nu o mențineți deschisă timp îndelungat.

- Pentru modelele cu condensator: curățați condensatorul o dată pe lună sau tot la 30 de cicluri de funcționare.
- Pentru modelele cu pompă de căldură: curățați sertarul filtrului periodic când există o acumulare vizibilă de puf sau când indicatorul de curățare al sertarului filtrului se iluminează.
- Pentru modelele cu coș de fum: respectați instrucțiunile pentru coșul de fum și curățați-l.
- În timpul ciclului de uscare, aerisiți bine încăperea unde este amplasat uscătorul dvs. de rufe.

4.5 Sarcina corectă

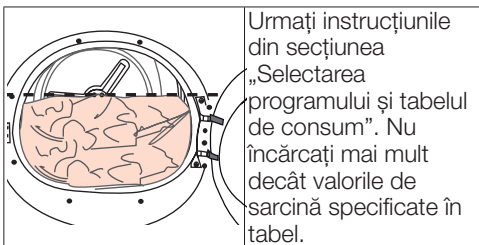

Următoarele valori de greutate sunt oferite drept exemplu.

Rufe	Approximate weights (g)*	Rufe	Approximate
Cuverturi din bumbac (duble)	1500	Bluze	150
Cuverturi din bumbac (simple)	1000	Cămăși din bumbac	300
Așternuturi (duble)	500	Cămăși	250
Așternuturi (simple)	350	Rochii din bumbac	500
Fețe de masă mari	700	Rochii	350
Fețe de masă mici	250	Blugi	700
Șervețele	100	Batiste (10 bucăți)	100
Prosoape de baie	700	Tricouri	125
Prosoape de mână	350		

*Greutatea rufelor uscate înainte de spălare.

5 Operarea produsului

5.1. Panoul de comandă

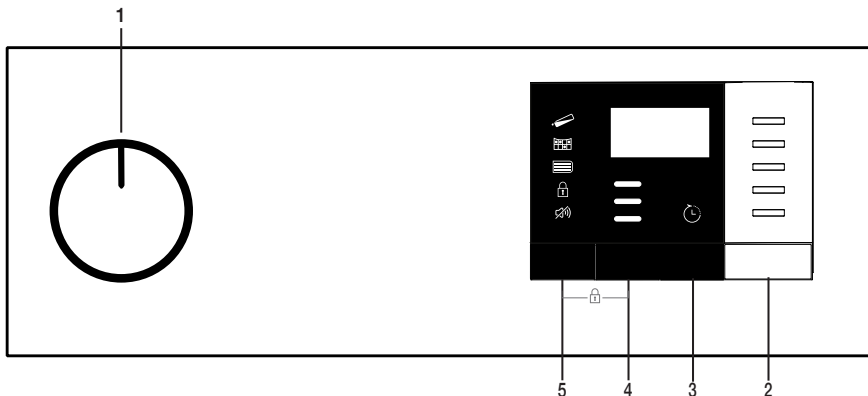

1. Buton de selectare On/Off/Program (Pornit/Oprit/Program)
2. Buton Start/Stand by (Pornire/Pauză)
3. Buton Sfârșitul programului
4. Butonul Nivel de uscare
5. Volum sonor/Butonul de selectare a timpului programelor

5.2 Simboluri

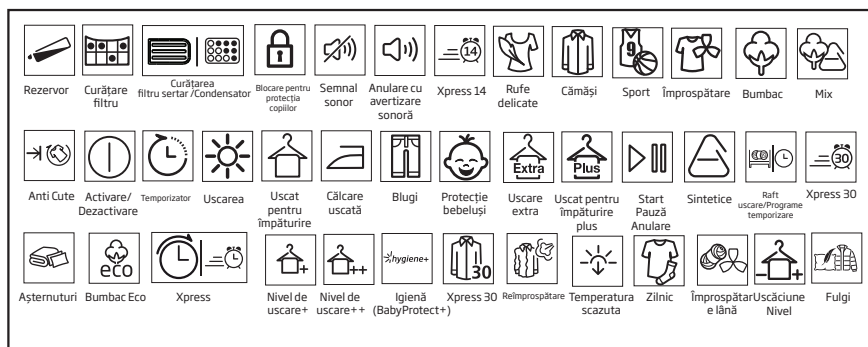

5.3. Pregătirea uscătorului

Cuplați uscătorul.

Deschideți ușa de încărcare.

Puneți rufe în uscător fără a umple exagerat.

Împingeți și închideți ușa de încărcare.

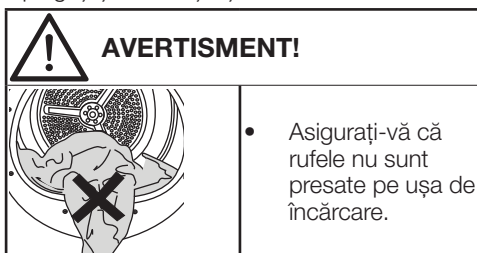

Atunci când selectați programul dorit folosind butonul de selecție On/Off/Program (Pornit/Oprit/Program), mașina va porni.

i REȚINEȚI

- Selectarea unui program folosind butonul de selectare On/Off/Program (Pornit/Oprit/Program) nu înseamnă că programul a început. Apăsăți butonul Start/Stand-by (Start/Pauză) pentru a începe programul.

5.4 Selectarea programelor și tabelul de consum

RO				
Programe	Descriere program	Capacitate (kg)	Viteza de stoarcere în mașina de spălat (rpm)	Temp de uscare (minute)
Uscare bumbac pentru călcare	Puteți usca rufe din bumbac pentru călcare în acest program pentru a fi ușor umede, gata de călcare. (cămașă, tricou, față de masă etc.)	7	1000	145
Bumbac Eco	Puteți usca toate rufe dvs. din bumbac în acest program. (tricouri, pantaloni, pijamale, haine de bebeluși, lenjerie intimă, pânză etc.) Puteți pune rufe în dulap fără călcare.	7	1000	179
Uscare bumbac pentru împăturire	Puteți folosi acest program pentru o uscare superioară a rufelor groase cum ar fi pantaloni, treninguri. Puteți să vă puneți rufe în șifonier fără a le călca.	7	1000	204
Uscare extra bumbac	Puteți usca rufe din bumbac gros în acest program precum prosoapele, halatele etc. Puteți pune rufe în dulap fără călcare.	7	1000	214
Uscare sintetice pentru călcare	Puteți usca rufe din materiale sintetice pentru călcare în acest program pentru a fi ușor umede, gata de călcare. (cămașă, tricou, față de masă etc.)	3,5	800	55
Uscare sintetice pentru împăturire	Puteți usca toate rufe dvs. din materiale sintetice în acest program. (cămașă, tricou, pantaloni, lenjerie intimă, fațade masă etc.) Puteți pune rufe în dulap fără călcare.	3,5	800	70
Programe temporizare	Puteți selecta programele de timp între 10 și 160 de minute, pentru a atinge la temperaturi scăzute nivelul de uscare dorit. În cadrul acestui program, funcționarea uscătorului cu tambur se întinde pe durata setată independent de nivelul de uscare a rufelor.	-	-	-
Refresh (Wool Refresh)	Se ventilează preț de 10 minute fără a sufla aer cald. Puteți ventila bumbacul și hainele de pânză care au fost închise o vreme îndelungată cu acest program pentru a îndepărta mirosul. Puteți folosi acest program pentru a ventila și înmuia lâna lrușelor din lână care pot fi spălate într-o mașină de spălat. Nu folosiți pentru uscare completă.	-	-	10
Îngrijire delicată/ Cămași	Uscă cămașile într-un mod mai delicat și nu șifonează foarte mult, necesitând mai puțină călcare	1,5	1200	50
Blugi	Puteți usca pantalonii, rochiile, cămașile sau hainele din denim în acest program.	4	1200	140
Exterior/Sporturi (Goretex)	Folosiți-l pentru a usca hainele făcute din sintetice, bumbac sau materiale amestecate sau produse rezistente la apă precum jachetele funcționale, pelerine etc. Întoarceți-le pe dos înainte de uscare.	2	1000	130
Mix(Zilnic)	Puteți usca cu acest program atât rufe din bumbac, cât și sintetice. Hainele de sport și fitness pot fi uscate cu acest program.	4	1000	125

Igienă (BabyProtect+)	E un prfogram pe termen lung pe care îl puteți folosi pentru haine (haine de copii, prosoape, lenjerie intimă, etc.) care necesită igienă specială. Igiena e oferită prin temperatura mare ((Acest program este identificat și aprobat de "The British Foundation" din Anglia (Allergy UK.))	5	800	195
Fulgi	Puteți usca haine precum paltoane și sacouri cu pene și fibre care au eticheta că pot fi uscate în uscător. Uscăți pe dos.	-	800	100
Xpress 30	Folosiți acest program pentru a avea 2 cămăși gata de călcat	0,5	1200	30

Valori ale consumului de energie

Programe	Capacitate (kg)	Viteza de stoarcere în mașina de spălat (rpm)	Cantitatea aproximativă de umezeală rămasă	Valoarea consumului de energie kWh
Bumbac Eco*	7	1000	60%	1,75
Uscare bumbac pentru călcare	7	1000	60%	1,40
Uscare sintetice pentru împăturire	3,5	800	40%	0,65
	"Programul de uscare bumbac Eco" folosit la capacitate maximă și parțială este programul de uscare standard la care se referă informațiile de pe etichetă și din fișa tehnică, adică acest program este adecvat pentru uscarea lenjeriei de bumbac normală udă și că este cel mai eficient program în termeni de consum de energie pentru bumbac.			

* : Cadrul privind directiva de etichetare energetică (EN 61121:2012) Toate valorile din tabel sunt determinate conform directivei EN 61121:2012. Valorile de consum pot varia în tabel în funcție de tipul de rufe, viteza de rotație, condițiile ambientale și schimbările în tensiune.



Allergy UK este o marcă a British Allergy Association. Ștampila de aprobare este creată pentru a-i ghida pe oamenii care necesită o recomandare despre un

produs pe care produsul respectiv în interzice / reduce / elimină alergenii sau reduce conținutul alergic în mod semnificativ în mediul în care există pacienții cu alergii. Are ca scop să ofere asigurări pe care produsele sunt testate în mod științific sau examinate astfel încât să ofere rezultate măsurabile.

5.5 Funcții auxiliare

Buzzer (Sonor) / timp

Uscătorul emite o avertizare sonoră atunci când programul este terminat. Dacă nu doriți să se emită un semnal sonor, apăsați butonul „Buzzer/Time” (Sonor/Timp). Când apăsați butonul Buzzer/Time (Sonor/Timp), se va aprinde un led iar la sfârșitul programului nu se va emite nici un sunet.



REȚINEȚI

- Puteți selecta această funcție înainte sau după pornirea programului.

Butonul Buzzer/Time (Sonor/Timp) este folosit pentru a regla durata programului când se selectează programele Rack/Time.

Nivel de uscare

Butonul de selectare a nivelului de uscare este folosit pentru reglarea nivelului de uscare dorit. Durata programului poate varia în funcție de selecție.



REȚINEȚI

- Puteți activa această funcție doar înainte de începerea programului.

Sfârșitul programului

Puteți prelungi durata programului cu până la 24 de ore cu funcția End Time (Sfârșitul programului).

1. Deschideți ușa de încărcare și introduceți rufe.
2. Selectați programul de uscare.
3. Apăsați butonul de selectare End Time (Sfârșitul programului) și alegeți amânarea pe

care o doriți. Ledul End Time se va ilumina. (Când este apăsat și ținut apăsat butonul, funcția End Time (Sfârșitul programului) este activată non-stop).

4. Apăsați butonul Start / Stand-by (Start/Pauză). Începe numărarea inversă pentru Sfârșitul programului. “.” Separatorul din mijlocul intervalului de temporizare afișat clipește.



REȚINEȚI

- Puteți adăuga sau îndepărta rufe în intervalul de temporizare. Timpul afișat este suma dintre timpul normal de uscare și timpul de finalizare. Ledul End Time (Sfârșitul programului) se va stinge la finalul numărării inverse, uscarea va începe iar ledul indicator al uscării se va ilumina.

Schimbarea timpului de finalizare

Dacă doriți să schimbați durata în timpul numărării inverse:

Anulați programul rotind butonul de selecție On/off/program (Pornit/Oprit/Program). Selectați programul dorit și repetați procedura de selectare a Sfârșitului de program. Anularea funcției Sfârșitul programului Dacă doriți să anulați numărătoarea inversă a sfârșitului de program și să începeți programul imediat:

Anulați programul rotind butonul de selecție On/off/program (Pornit/Oprit/Program).

Selectați programul dorit și apăsați butonul Start / Stand-by (Start/Pauză).

5.6 Indicatoare avertizare



REȚINEȚI

- Puteți activa această funcție doar înainte de începerea programului.



REȚINEȚI

- Indicatoarele de avertizare pot diferi în funcție de modelul uscătorului dvs.

Curățarea filtrului

Atunci când programul este terminat, indicatorul de avertizare pentru curățarea filtrului se aprinde.

Rezervorul de apă

Dacă rezervorul de apă se umple în timp ce programul funcționează, indicatorul de avertizare începe să clipească iar mașina intră în stand-by. În acest caz, goliți apa din rezervor și porniți programul apăsând butonul Start / Pause (Start/Pauză). Indicatorul de avertizare se stinge iar programul este reluat.

5.7 Pornirea programului

Apăsați butonul Start/Stand-by (Start/Pauză) pentru a începe programul. Indicatorii Start/Stand-by (Start/Pauză) și Drying (Uscare) se vor ilumina pentru a arăta că programul a început.

5.8. Blocare de siguranță pentru copii

Mașina are o funcție de siguranță pentru copii ce face ca fluxul programului mașinii să nu fie afectat dacă sunt apăsat butoanele în timpul funcționării. Atunci când funcția de blocare de siguranță pentru copii este activată, toate butoanele de pe panou, cu excepția butonului On/Off/Program sunt dezactivate. Apăsați butoanele Nivel de uscare și Buzzer simultan pentru 3 secunde pentru a activa blocarea de siguranță pentru copii. Blocarea de siguranță pentru copii trebuie să fie dezactivată pentru a putea porni un nou program după ce se termină programul curent sau pentru a putea interveni în programul curent. Pentru a dezactiva blocarea de siguranță pentru copii, țineți apăsat aceleași butoane timp de 3 secunde.



REȚINEȚI

- Atunci când blocarea de siguranță pentru copii este activată, indicatorul funcției de blocare de pe ecran se aprinde.
- Blocarea de siguranță pentru copii se dezactivează atunci când uscătorul este oprit și repornit folosind butonul On/Off/Cancel (Pornire/Oprire/Anulare).

Atunci când blocarea de siguranță pentru copii este activată:

Atunci când uscătorul funcționează, sau este în standby, simbolurile indicatoare nu se vor schimba la modificarea poziției comutatorului de selectare.



REȚINEȚI

- Atunci când uscătorul funcționează iar blocarea de siguranță pentru copii este activată, la rotirea comutatorului de selectare se vor auzi două bipuri. Dacă blocarea de siguranță pentru copii este dezactivată fără a readuce comutatorul de selectare în poziția sa anterioară, programul va lua sfârșit datorită modificării poziției comutatorului de selectare a programelor.

5.9 Schimbarea programului după pornire

Puteți schimba programul selectat pentru a usca rufe dvs. cu un program diferit după ce mașina începe să funcționeze.

De exemplu, selectați programul Extra Dry (Foarte uscat) rotind comutatorul de selectare On/Off/Program (Pornit/Oprit/Program) pentru a selecta Extra Dry în loc de Iron Dry (Uscare normală).

Apăsați butonul Start/Stand-by (Start/Pauză) pentru a începe programul.

Adăugarea și scoaterea hainelor în modul stand-by

Dacă doriți să adăugați sau să scoateți haine în/din uscător după începerea programului de uscare:

Apăsați butonul Start/Stand-by (Start/Pauză) pentru a aduce uscătorul în modul Stand-by. Operațiunea de uscare se oprește.

Deschideți ușa de încărcare în timpul modului Stand-by (Pauză) și închideți ușa după ce ați adăugat sau scos rufe.

Apăsați butonul Start/Stand-by (Start/Pauză) pentru a începe programul.



REȚINEȚI

- Adăugarea de rufe după ce operațiunea de uscare a început poate face ca rufele uscate din interiorul mașinii să se amestece cu rufele ude și să rămână umede după terminarea operațiunii.
- Adăugarea sau îndepărtarea rufelor poate fi repetată de câte ori doriți. Dar această operațiune întrerupe în mod constant operațiunea de uscare și ar face ca durata programului să se prelungească și să mărească consumul de energie. Astfel, este recomandat să adăugați rufe înainte de începerea programului.
- Dacă este selectat un nou program prin schimbarea poziției comutatorului de selectare a programelor în timp ce uscătorul este în modul stand-by, programul în derulare ia sfârșit.

5.11 Terminarea programului

Când programul se încheie, LED-urile Ultimul/ Anti-șifonare și Avertismentul pentru curățarea filtrului de pe indicatorul urmăririi programului se va ilumina. Ușa de încărcare poate fi deschisă iar uscătorul este gata pentru un nou ciclu. Aduceți comutatorul de selectare On/Off/Program (Pornit/Oprit/Program) în poziția On/Off pentru a opri uscătorul.



REȚINEȚI

- Dacă rufe nu sunt scoase după ce programul este terminat, se va activa funcția de prevenire a șifonării timp de 2 ore pentru a evita șifonarea rufelor în interiorul uscătorului. Programul va roti rufe la intervale de 10 minute pentru a preveni șifonarea.



AVERTISMENT!

- Nu atingeți suprafața interioară a tamburului atunci când adăugați sau scoateți rufe în timpul unui program în derulare. Suprafața tamburului este fierbinte.

5.10 Anularea programului

Dacă doriți să anulați programul și să încheiați operațiunea de uscare din orice motiv după ce uscătorul începe să funcționeze, rotiți comutatorul de selectare On/Off/Cancel (Pornit/Oprit/Anulare) iar programul va fi anulat.



AVERTISMENT!

- Interiorul uscătorului va fi extrem de încins atunci când anulați programul în timpul funcționării mașinii, deci rulați programul de ventilare pentru a-i permite să se răcească.

6 Întreținerea și curățarea

6.1 Suprafața interioară a ușii de încărcare

Părul și scamele care sunt separate de rufe în timpul procesului de uscare este strâns de Filtrul de scame.



NOTĂ

- Scamele se formează în timpul purtării și spălării hainelor.
- Puteți curăța compartimentul filtrului de scame cu un aspirator.

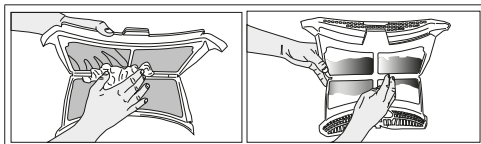

- Curățați ambele filtrele sub jetul de apă în direcție inversă a acumulării scamei sau cu o perie moale. Uscați filtrul înainte de a-l pune la loc.

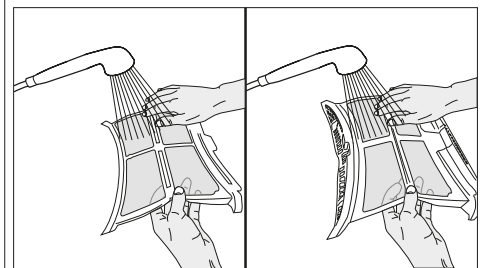

AVERTISMENT!

- După fiecare ciclu de uscare, curățați filtrul de scame și suprafața interioară a ușii de încărcare.

Pentru a curăța filtrul de scame:

- Deschideți ușa de încărcare.
- Țineți prima parte (filtrul interior) al filtrului de scame format din două părți și îndepărtați-l trăgând în sus.
- Curățați părul, scamele și resturile de bumbac manual sau cu o cârpă moale.
- Îndepărtați a doua parte (filtrul exterior) trăgându-l în sus.

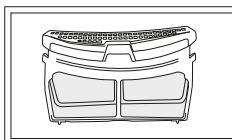

- Introduceți filtrele de scame unul în altul și puneți-le la loc.

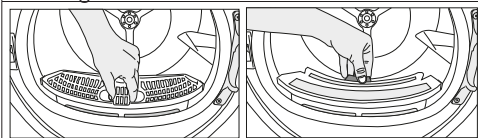

- Curățați interiorul ușii de încărcare și spălătorul cu o cârpă moale și umedă.

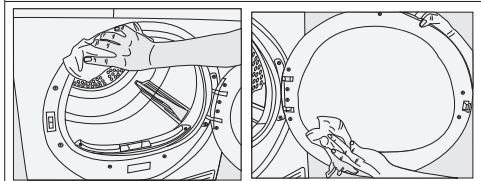

NOTĂ

- Asigurați-vă că părul, scamele și resturile de bumbac nu cad în fanta în care sunt instalate filtrele.

- Deschideți ambele filtrele de scame (filtrele interioare și exterioare) îndepărtați părul, scamele, resturile de bumbac cu mâna umedă, un aspirator sau o cârpă.

6.2 Curățarea senzorilor

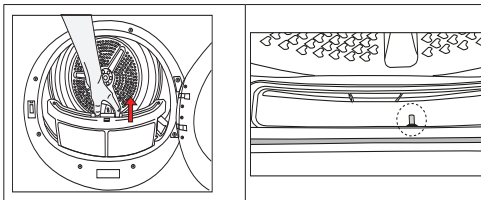

- Există senzor de temperatură în uscător care detectează dacă rufele sunt sau nu uscate
- Pentru a curăța senzorii:
- Deschideți ușa de încărcare a uscătorului.
- Scoateți filtrul de scame trăgând în sus.
- Curățați senzorul cu mâna dacă are acumulare de scame pe el.



NOTĂ

- Curățați senzorul de 4 ori pe an.
- Nu folosiți instrumente metalice atunci când curățați senzorul.
- Permiteți mașinii să se răcească dacă este încă încinsă din cauza procesului de uscare.



AVERTIZARE!

- Nu folosiți niciodată solvenți, agenți de curățare sau substanțe similare pentru curățare din cauza riscului de foc sau explozie!



AVERTISMENT!

- Nu folosiți niciodată solvenți, agenți de curățare sau substanțe similare pentru curățare din cauza riscului de foc sau explozie!

6.3 Golirea rezervorului de apă

Umezeala rufelor este îndepărtată și condensată în timpul procesului de uscare și apa care crește se acumulează în rezervorul de apă. Goliți rezervorul de apă după fiecare ciclu de uscare.



AVERTISMENT!

- Apa condensată nu este potabilă!
- Nu îndepărtați niciodată rezervorul de apă atunci când programul rulează!

Dacă uitați să goliți rezervorul de apă, mașina se va opri în timpul ciclurilor de uscare ulterioare atunci când rezervorul de apă este plin și simbolul de avertizare Rezervor Apă clipește. În acest caz, goliți rezervorul de apă și apăsați butonul Start / Pause pentru a relua ciclul de uscare.

Golirea rezervorului de apă:

1. Scoateți cu grijă rezervorul de apă din sertar sau suport.

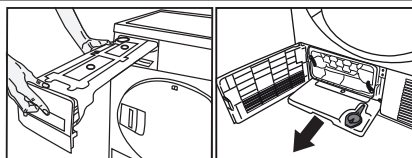

2. Goliți apa din rezervor.

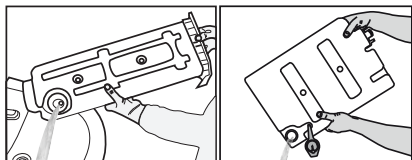

- Dacă există acumulare de scame în pâlnia rezervorului de apă, curățați-o sub apă curentă.
- Amplasați rezervorul de apă la locul său.



NOTĂ

- Dacă aveți opțiunea de scurgere directă a apei, nu e nevoie să goliți rezervorul de apă.

6.4 Curățarea evaporatorului

Părul și fibrele care nu sunt prinse de filtrul de scame se acumulează în nervurile evaporatorului din spatele plinte. Dacă pictograma evaporatorului clipește sau într-o perioadă de 3 luni, curățați evaporatorul.

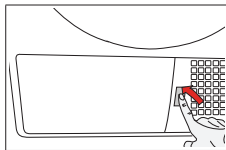

- Deschideți plinta apăsând pe ea.

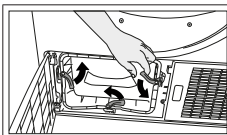

- Pentru a deschide ușa de rutare a aerului, mișcați mecanismul de eliberare.

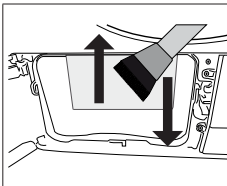

- Curățați scamele pe evaporator cu o cârpă umedă / cu un aspirator cu o perie printr-o mișcare în sus și în jos.

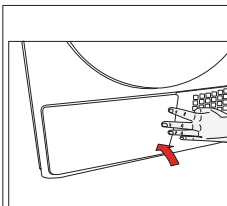

- După încheierea procesului de curățare, puneți ușa de rutare a aerului la locul ei, mutați mecanismele pentru a o închide și închideți plinta.



AVERTISMENT!

- Puteți curăța manual, cu condiția să purtați mănuși protectoare. Nu încercați să curățați cu mâinile goale. Nervurile evaporatorului vă pot vătăma mâinile.
- Curățarea cu mișcări la stânga și la dreapta poate cauza avaria nervurilor evaporatorului. Acest lucru poate duce la probleme de uscare.

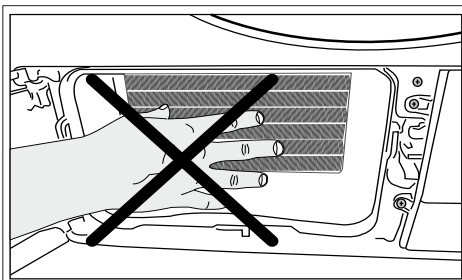

7 Depanare

Operațiunea de uscare durează prea mult.
Porii filtrului de scame (filtrul interior și exterior) poate fi înfundat. >>> Spălați filtrele de scame cu apă caldă și uscați-le. Partea din față a evaporatorului poate fi înfundată. >>> Curățați partea din față a evaporatorului. Grilele de aerisire din partea din față a mașinii ar putea fi obstructionate. >>> Îndepărtați orice obiecte din fața grilelor de aerisire ce blochează fluxul de aer. Ventilarea ar putea fi insuficientă datorită faptului că spațiul în care este instalată mașina este prea mic. >>> Deschideți ușa sau fereastra pentru a evita creșterea excesivă a temperaturii în cameră Posibilă acumulare de calcar pe senzorul de umiditate. >>> Curățați senzorul de umiditate. Încărcare excesivă cu rufe. >>> Nu încărcăți uscătorul excesiv. Este posibil ca rufe să nu fi fost centrifugate în mod adecvat. >>> Efectuați o centrifugare la turație mai mare.
Hainele sunt umede după uscare.
Este posibil să se fi folosit un program necorespunzător pentru tipul de rufe.>>> Verificați etichetele de întreținere de pe haine și selectați un program corespunzător cu tipul de haine sau folosiți suplimentar un program de durată. Porii filtrului de scame (filtrul interior și exterior) poate fi înfundat. >>> Spălați filtrele de scame cu apă caldă și uscați-le. Partea din față a evaporatorului poate fi înfundată. >>> Curățați partea din față a evaporatorului. Încărcare excesivă cu rufe. >>> Nu încărcăți uscătorul excesiv. Este posibil ca rufe să nu fi fost centrifugate în mod adecvat. >>> Efectuați o centrifugare la turație mai mare.
Uscătorul nu pornește sau un program nu poate fi pomit. Uscătorul nu pornește după ce este programat.
Cablul de alimentare ar putea fi deconectat. >>> Asigurați-vă de conectarea cablului de alimentare. Ușa de încărcare ar putea fi deschisă. >>> Asigurați-vă că ușa de încărcare este bine închisă. Un program ar putea să nu fie setat sau butonul Start / Pause / Cancel (Start/Pauză/Anulare) ar putea să nu fie apăsat. >>> Verificați ca programul să fie setat și să nu fie pe poziția de Pauză. Blocarea de siguranță pentru copii ar putea fi activată. >>> Dezactivați blocarea de siguranță pentru copii.
Programul a fost întrerupt fără motiv.
Este posibil ca ușa de încărcare să nu fi fost închisă bine. >>> Asigurați-vă că ușa de încărcare este bine închisă. Ar putea exista o întrerupere de curent. >>> Apăsăți butonul Start/Pause/Cancel (Start/Pauză/Anulare) pentru a începe programul. E posibil ca rezervorul de apă să fie plin. >>> Goliți rezervorul de apă.
Hainele s-au micșorat, s-au întărit sau s-au deteriorat.
Este posibil să se fi folosit un program necorespunzător cu tipul de haine. >>> Verificați etichetele de întreținere de pe haine și selectați un program adecvat tipului acestora.

Scurgeri de apă de la ușa de încărcare.
S-au acumulat scame pe suprafețele interne ale ușii de încărcare și pe garnitura ușii de încărcare. >>> Curățați suprafețele interioare ale ușii de încărcare și pe cele ale garniturii ușii de încărcare.
Ușa de încărcare se deschide singură.
Este posibil ca ușa de încărcare să nu fi fost închisă bine. >>> Apăsăți ușa de încărcare până ce se aude sunetul de închidere.
Simbolul de avertizare rezervor apă se aprinde sau clipește.
E posibil ca rezervorul de apă să fie plin. >>> Goliți rezervorul de apă. Furtunul de golire a apei poate fi defect. >>> Dacă produsul este conectat direct la rețeaua de scurgerea menajeră, verificați furtunul de scurgere a apei.
Lumina din interiorul uscătorului nu se aprinde. (La modelele cu lămpi)
Este posibil ca uscătorul să nu fi fost pomit folosind butonul On/Off (Pomire/Oprire). >>> Asigurați-vă că uscătorul este pomit. E posibil ca lampa să nu funcționeze. >>> Contactați un Service Autorizat pentru a înlocui lampa.
Pictograma de antișifonare e aprinsă.
Este posibil să fi activat modul de antișifonare care împiedică rufele din uscător să se șifoneze. >>> Oprți uscătorul și scoateți rufele.
Pictograma de curățare a filtrului de scame este aprinsă.
Filtrul de scame (filtrul interior și exterior) poate fi murdar. >>> Spălați filtrele de scame cu apă caldă și uscați-le. Se poate forma un strat pe porii filtrului de scame care duce la înfundare. >>> Spălați filtrele de scame cu apă caldă și uscați-le. Este posibil ca filtrele de scame să nu fie introduse. >>> Introduceți filtrele interior și exterior la locurile lor.
O avertizare sonoră se aude din mașină.
Este posibil ca filtrele de scame să nu fie introduse. >>> Introduceți filtrele interior și exterior la locurile lor.
Pictograma de avertizare a evaporatorului clipește.
Partea din față a evaporatorului poate fi înfundată cu scame. >>> Curățați partea din față a evaporatorului. Este posibil ca filtrele de scame să nu fie introduse. >>> Introduceți filtrele interior și exterior la locurile lor.
Lumina din interiorul uscătorului se aprinde. (La modelele cu lămpi)
Dacă uscătorul este conectat la priză, butonul On/Off (Pomit/Oprit) este apăsat și ușa se deschide; lumina se aprinde. >>> Scoateți din priză uscătorul sau treceți butonul On/Off (Pomit/Oprit) în poziția Off (Oprit).



AVERTISMENT!

- Dacă problema persistă după ce ați urmat instrucțiunile din acest capitol, contactați distribuitorul dvs. sau un centru de service autorizat. Nu încercați niciodată să vă reparați singur aparatul.



NOTĂ

- În cazul în care întâmpinați o problemă de orice fel la aparat, puteți solicita înlocuirea contactând un service autorizat cu numărul de model al aparatului.
- Operarea aparatului cu părți neautentice poate duce la defectarea aparatului.
- Producătorul și distribuitorul nu răspund de defectele care rezultă din părțile neautentice.

FIȘĂ PRODUS

REGULAMENTUL DELEGAT (UE) NR. 392/2012 AL COMISIEI

Nume furnizor și marcă înregistrată		BEKO
Denumire model		DF7412PA 7188301400
Capacitate nominală (kg)		7.0
Tip uscător	Ventilat	-
	Condensator	•
Clasa eficienței consumului de energie ⁽¹⁾		A++
Consum anual de energie (kWh) ⁽²⁾		212,0
Tip Control	Automat	•
	Neautomat	-
Consum energie program bumbac standard la încărcare maximă (kWh)		1,75
Consum energie program bumbac standard la încărcare maximă parțială (kWh)		0,96
Consumul de energie al modului off (oprit) pentru programul standard pentru bumbac la capacitate maximă, P ₀ (W)		0,50
Consumul de energie al modului left-on (lăsat pornit) pentru programul standard pentru bumbac la capacitate maximă, P ₁ (W)		1,00
Durata modului lăsat pornit (min)		30
Program bumbac standard ⁽³⁾		•
Timp program bumbac standard la încărcare maximă, T _{dy} (min)		179
Timp program bumbac standard la încărcare parțială, T _{dy1/2} (min)		107
Timp program ponderat bumbac standard la încărcare maximă și încărcare parțială (T ₁)		138
Clasa eficienței condensării ⁽⁴⁾		B
Eficiență condensare medie program bumbac standard la încărcare parțială, C _{dy}		81%
Eficiență condensare medie program bumbac standard la încărcare parțială, C _{dy1/2}		81%
Eficiență ponderată program bumbac standard la încărcare maximă și încărcare parțială, C ₁		81%
Nivel putere sunet program bumbac standard la încărcare maximă ⁽⁵⁾		65
Integrat		-

• : Da - : Nu

(1) Scara de la A+++ (cea mai mare eficiență) la D (cea mai mică eficiență)

(2) Consum energie pe baza a 160 cicluri de uscare a programului bumbac standard la încărcare maximă și parțială, și consumul modurilor cu putere redusă. Consumul de energie real per ciclu va depinde de modul de folosire al aparatului.

(3) "Programul de uscare bumbac pentru dulap" folosit la capacitate maximă și parțială este programul de uscare standard la care se referă informațiile de pe etichetă și din fișa tehnică, adică acest program este adecvat pentru uscarea lenjeriei de bumbac normală udă și că este cel mai eficient program în termeni de consum de energie pentru bumbac.

(4) Scara de la G (cea mai mică eficiență) la A (cea mai mare eficiență)

(5) Valoare ponderată medie — L_{WA} exprimată în dB(A) re 1 pW

