



Built-in Oven
User Manual



BCW14400B-BQW12400X-BQW14400B

EN

285.4455.47/R.AI/6.08.2021
7758088307-7758089203-7731686326

Please read these instructions first before using your appliance

Thank you for choosing a Beko appliance.

Please take some time to read this user manual before using your appliance, to ensure you know how to safely operate the controls and functions.

Carefully follow all unpacking and installation instructions to ensure the appliance is correctly connected and fitted prior to use.

Please write your product model and serial number on the last page of this user manual, and store in a safe location close to the appliance for easy future reference.

This user manual may also be applicable for several other models. Differences between models will be listed.

If you have any questions or concerns, please call our contact centre or find help and information online at www.beko.co.uk

Explanation of symbols used throughout this User Manual

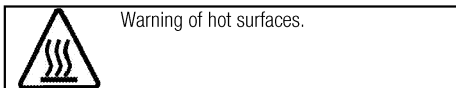
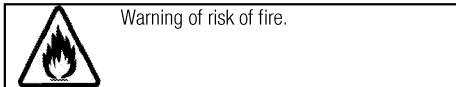
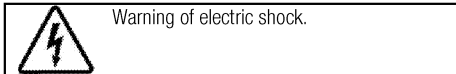
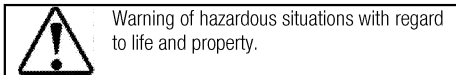

This product was manufactured using the latest technology in environmentally friendly conditions.

TABLE OF CONTENTS

1 Important instructions for safety and environment 4

General safety.....	4
Electrical safety.....	4
Product safety.....	5
Safety instructions for microwave.....	7
Intended use.....	10
Safety for children.....	11
Disposing of the old product.....	11
Package information.....	12

2 General information 13

Overview.....	13
Package contents.....	14
Technical specifications.....	15

3 Installation 16

Before installation.....	16
Installation and connection.....	19
Future Transportation.....	20

4 Preparation 21

Tips for saving energy.....	21
Initial use.....	21
Day time setting.....	21
First cleaning of the appliance.....	22
Initial heating.....	22

5 How to operate the microwave 23

General information on microwave cooking.....	23
How to use the microwave oven.....	27
Operating modes for microwave.....	31
Cooking times table.....	32

6 How to operate the oven 33

General information on baking, roasting and grilling.....	33
How to operate the electric oven.....	33
Operating modes.....	34
How to operate the oven control unit.....	35
Cooking times table.....	39
Operating the grill.....	40
Cooking times table for grilling.....	40

7 Maintenance and care 41

General information.....	41
Cleaning microwave oven part.....	41
Cleaning the control panel.....	41
Cleaning the oven.....	41
Replacing the oven lamp.....	42

8 Troubleshooting 43

9 Guarantee Details 45

Important instructions for safety and environment

This section contains safety instructions that will help protect from risk of personal injury or property damage. Failure to follow these instructions shall void any warranty.

General safety

- This appliance can be used by children aged from 8 years and above and persons with reduced physical, sensory or mental capabilities or lack of experience and knowledge if they have been given supervision or instruction concerning use of the appliance in a safe way and understand the hazards involved. Children shall not play with the appliance. Cleaning and user maintenance shall not be made by children without supervision.
- The appliance is not to be used by persons (including children) with reduced physical, sensory or mental capabilities, or lack of experience and knowledge, unless they have been given supervision or instruction. Children should be supervised and ensure they do not play with the appliance
- If the product is handed over to someone else for personal use or second-hand use purposes, the user manual, product labels and

other relevant documents and parts should be also given.

- Installation and repair procedures must always be performed by Authorised Service Agents. The manufacturer shall not be held responsible for damages arising from procedures carried out by unauthorised persons which may also void the warranty. Before installation, read the instructions carefully.
- Do not operate the product if it is defective or has any visible damage.
- Ensure that the product function knobs are switched off after every use.

Electrical safety

- If the product has a failure, it should not be operated unless it is repaired by the Authorized Service Agent. There is the risk of electric shock!
- Only connect the product to a grounded outlet/line with the voltage and protection as specified in the “Technical specifications”. Have the grounding installation made by a qualified electrician while using the product with or without a transformer. Our company shall not be liable for any problems

arising due to the product not being earthed in accordance with the local regulations.

- Never wash the product by spreading or pouring water onto it! There is the risk of electric shock!
- The product must be disconnected during installation, maintenance, cleaning and repairing procedures.
- If the power connection cable for the product is damaged, it must be replaced by the manufacturer, its service agent or similar qualified persons in order to avoid a hazard.
- The appliance must be installed so that it can be completely disconnected from the mains supply. The separation must be provided by a switch built into the fixed electrical installation, according to construction regulations.
- Rear surface of the oven gets hot when it is in use. Make sure that the electrical connection does not contact the rear surface; otherwise, connections can get damaged.
- Do not trap the mains cable between the oven door and frame and do not route it over hot surfaces. Otherwise, cable insulation may melt and cause fire as a result of short circuit.

- Any work on electrical equipment and systems should only be carried out by authorized and qualified persons.
- In case of any damage, switch off the product and disconnect it from the mains. To do this, turn off the fuse at home.
- Make sure that fuse rating is compatible with the product.

Product safety

- **WARNING:** The appliance and its accessible parts become hot during use. Care should be taken to avoid touching heating elements. Children less than 8 years of age shall be kept away unless continuously supervised.
- Never use the product when your judgment or coordination is impaired by the use of alcohol and/or drugs.
- Be careful when using alcoholic drinks in your dishes. Alcohol evaporates at high temperatures and may cause fire since it can ignite when it comes into contact with hot surfaces.
- Do not place any flammable materials close to the product as the sides may become hot during use.
- During use the appliance becomes hot. Care should be

taken to avoid touching heating elements inside the oven.

- Keep all ventilation slots clear of obstructions.
- Do not heat closed tins and glass jars in the oven. The pressure that would build-up in the tin/jar may cause it to burst.
- Do not place baking trays, dishes or aluminium foil directly onto the bottom of the oven. The heat accumulation might damage the bottom of the oven.
- Do not place aluminium foil on the base of the tray.
- Do not use harsh abrasive cleaners or sharp metal scrapers to clean the oven door glass since they can scratch the surface, which may result in shattering of the glass.
- Do not use steam cleaners to clean the appliance as this may cause an electric shock.
- Placing the wire shelf and tray onto the wire racks properly
It is important to place the wire shelf and/or tray onto the rack properly. Slide the wire shelf or tray between 2 rails and make sure that it is balanced before placing food on it (Please see the following figure).

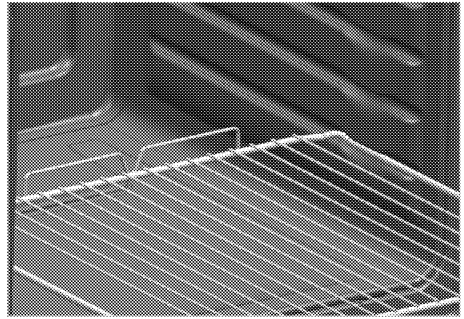

- Do not use the product if the front door glass removed or cracked.
 - The Oven handle is not a towel dryer. Do not hang up towels, gloves, or similar textile products when the grill function is being used with the door open.
 - Always use heat resistant oven gloves when putting in or removing dishes into/from the hot oven.
 - **WARNING:** Ensure that the appliance is switched off before replacing the lamp to avoid the possibility of electric shock.
 - The appliance must not be installed behind a decorative door in order to avoid overheating.
- Prevention against possible fire risk!
- Ensure all electrical connections are secure and tight to prevent risk of arcing.
 - Do not use damaged cables or extension cables.
 - Ensure liquid or moisture is not accessible to the electrical connection point.

Safety instructions for microwave

- The appliance is intended to be used in household and similar applications as:
 - staff kitchen areas in shops, offices and other working environments;
 - farm houses;
 - by clients in hotels, motels and other residential environments;
 - bed and breakfast type environments.
- The appliance is intended to be used in domestic households only. The appliance is not to be used in commercial outlet.
- Only allow children aged from 8 year to use the oven without supervision when adequate instructions have been given so that the child is able to use the microwave oven in a safe way and understands the hazards of improper use.
- When the appliance is operated in the combination mode, children aged from 8 years should only use the oven under adult supervision due to the temperature generated.
- The exposed parts of the product will become hot while and after the product is in use.
- Check the oven for any damage, such as a misaligned or bent door, damaged door seals and sealing surface, broken or loose door hinges and latches and dents inside the cavity or on the door. If there is any damage, do not operate the oven and contact an Authorised Service Agent.
- If the door or door seals are damaged, the oven must not be operated until it has been repaired by a competent person or Authorised Service Agent.
- Before operating your oven ensure that the door has been closed properly. A safety mechanism in the door lock prevents your appliance from operating when the door is open, halting the cooking operation if you open the door. You should not interfere with the door locking system or attempt to override this system. If the door locking system is overridden, risk of exposure to microwaves arises if the appliance is operated with an open door.
- Do not place any kind of object between the front of the oven and the door. You should not operate your oven if objects such as paper towels or napkins prevent it from being closed properly.
- Radio Interference
Place the oven no less than 2 metres from TVs, radios, wireless

modems, access points and aeriels. Otherwise it may cause interference.

- Do not cook your meals with the cooking time and microwave power set excessively high. Excessive cooking may, burn some parts of the meal.
- **Never use aluminum foil or aluminum utensils for microwave cooking.** Sparks will damage the appliance.
- Do not use metal objects closer than 3 cm to the oven door while cooking with microwave.
- Do not place corrosive chemicals or materials containing corrosive vapor into the oven.

When there is interference, it may be reduced or eliminated by taking the following measures:

1. Clean door and sealing surface of the oven.
 2. Reorient the receiving antenna of radio or television.
 3. Relocate the microwave oven with respect to the receiver.
 4. Move the microwave oven away from the receiver.
 5. Connect the microwave oven into a different outlet so that the microwave oven and receiver are on different circuits.
- Place the oven away from other heating appliances and avoid

using in damp or steamy environments.

- It is hazardous for anyone other than a competent person or an Authorised Service Agent to carry out any service or repair operation that involves the removal of a cover which gives protection against exposure to microwave energy.
- This product is a Group 2 Class B ISM equipment. The definition of Group 2 which contains all ISM (Industrial, Scientific and Medical) equipment in which radio-frequency energy is intentionally generated and/or used in the form of electromagnetic radiation for the treatment of material, and spark erosion equipment. For Class B equipment is equipment suitable for use in domestic establishments and in establishments directly connected to a low voltage power supply network which supplies buildings used for domestic purpose.
- The microwave oven is intended for heating food and beverages. Drying of food or clothing and heating or warming pads, slippers, sponges, damp cloth and similar may lead to risk of injury, ignition or fire.
- Your oven has not been designed for drying any living beings.

- **Do not operate** your oven when it is **empty**. This may damage the oven. Should you wish to test the oven, place a glass of water inside. The water will absorb the microwave energy and the oven will suffer no damage.
- Only use utensils that are suitable for use in microwave ovens.

Do not use earthenware containers for microwave cooking. Moisture in the earthenware may expand and cause cracking of your container.

To reduce the risk of fire in the oven cavity:

- When heating food in plastic or paper containers, keep an eye on the oven due to the possibility of ignition. If smoke is observed, switch off or disconnect the appliance and keep the door closed in order to stifle any flames.
- Remove wire twist-ties from paper or plastic bags before placing bag in oven.
- Do not use the cavity for storage purposes. Do not leave paper products, cooking utensils or food in the cavity when not in use.
- If you use materials like paper, wood or plastic for cooking in your microwave, do not leave the oven unattended. Paper, wood and similar materials may ignite,

while plastic materials may melt. Do not use containers made of such materials for fan oven, grilling and mixed cooking operations.

- The contents of feeding bottles and baby food jars should be stirred or shaken and the temperature checked before consumption, in order to avoid burns.
- Liquids and other foods must not be heated in sealed containers since they are liable to explode.
- Microwave heating of beverages can result in delayed eruptive boiling, therefore care must be taken when handling the container.
- Eggs in their shell and whole hard-boiled eggs should not be heated in microwave ovens since they may explode, even after microwave heating has ended.
- Do not use your oven to heat carbonated drinks or foods stored in airtight containers like tin cans. This will cause pressure to build up inside the oven that may result in damage or explosion when the door is opened.
- Do not use your microwave oven for cooking or reheating unwhisked eggs, whether shelled or not. Ensure that you pierce the skins of potatoes, apples, chestnut

or similar fruits and vegetables before cooking.

- Do not use porcelain containing metal (silver, gold, etc.). Ensure that you remove all metal twist-ties from food packages. Pieces of metal inside the oven can cause arcing that may result in serious damage.
- Do not use your oven for frying with oil since you will be unable to regulate the temperature of the oil.

Do not use the microwave to warm cooking oil or drinks with high alcohol volume.

- Do not place the oven where heat, moisture, or high humidity are generated, or near combustible materials.
- Do not use the interior of your oven for storage purposes.
- Do not lean on the oven door when it is open, or let children swing on it. This will warp the oven door and prevent it from closing properly.
- Put a metal teaspoon or glass rod in the container when heating up liquids. This will prevent delay of boiling of the liquid, thus prevent sudden overflowing when the container is moved.
- Do not use the oven, if:
 - The door is not closed properly;
 - The door hinges are damaged;

- The contact surfaces between the door and the front side of the oven are damaged;
- The door window is damaged;
- An electrical arc occurs within the oven although there are no metal object in the cooking segment.
- It is very important not to select long durations or extremely high power levels while cooking a small amount of food in order to avoid overheating or burning the meal. For example, a slice of bread may burn after 3 minutes if a very high power level is selected.
- Do not use the oven for frying as it is not possible to control the temperature of oil heated in microwave.
- Contact surfaces of the door (front side of the inner segment and inner side of the doors), must be kept clean to ensure proper operation of the oven.

Intended use

- This product is designed for domestic use. Commercial use will void the guarantee.
- This appliance is for cooking purposes only. It must not be used for other purposes, for example room heating.
- This appliance is not intended for use at mobile homes, recreational vehicles and similar places.

- Use your oven indoors. Do not use it in gardens, on balconies or in other outdoor settings.
- This product should not be used for warming plates under the grill, drying towels, dish cloths etc. by hanging them on the oven door handles. This product should also not be used for room heating purposes.
- All openings in the wall behind the appliance and in the floor under the appliance shall be sealed.
- Do not obstruct the flow of ventilation air.
- The manufacturer shall not be liable for any damage caused by improper use or handling errors.
- The oven can be used as a microwave, for defrosting, baking, roasting and grilling food.
- operating and do not allow them to play with the product.
- When the appliance is operated in combination mode, children aged from 8 years should only use the oven under adult supervision due to temperature generated.
- The exposed parts of the product will become hot while and after the product is in use.
- Do not place any items above the appliance that children may reach for.
- When the door is open, do **not** load any heavy object on it and do **not** allow children to sit on it. It may overturn or door hinges may get damaged.

Safety for children

- **WARNING:** Accessible parts may become hot during use. Young children should be kept away.
- The packaging materials will be dangerous for children. Keep the packaging materials away from children. Please dispose of all parts of the packaging according to environmental standards.
- Electrical products are dangerous to children. Keep children away from the product when it is

Disposing of the old product

Compliance with the WEEE

Directive and Disposing of the Waste Product:



This product complies with EU WEEE Directive (2012/19/EU). This product bears a classification symbol for waste electrical and electronic equipment (WEEE).

This product has been manufactured with high quality parts and materials which can be reused and are suitable for recycling. Do not dispose of the waste product with normal domestic and other wastes at the end of its

service life. Take it to the collection center for the recycling of electrical and electronic equipment. Please consult your local authorities to learn about these collection centers.

Compliance with RoHS Directive:

The product you have purchased complies with EU RoHS Directive (2011/65/EU). It does not contain harmful and prohibited materials specified in the Directive.

Package information

- Packaging materials of the product are manufactured from recyclable materials in accordance with our National Environment Regulations. Do not dispose of the packaging materials together with the domestic or other wastes. Take them to the packaging material collection points designated by the local authorities.

2 General information

Overview

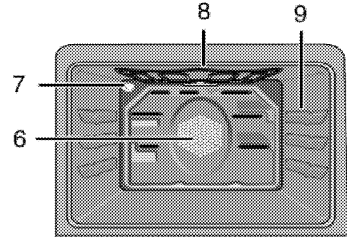
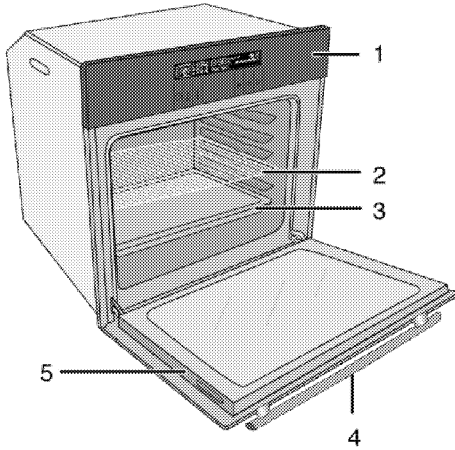

- 1 Control panel
- 2 Wire shelf
- 3 Tray
- 4 Handle
- 5 Front door

- 6 Fan motor (behind steel plate)
- 7 Lamp
- 8 Top heating element
- 9 Shelf positions

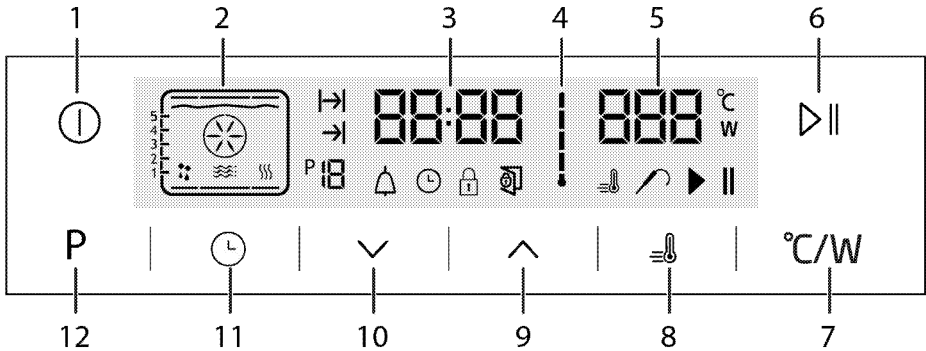

- 1 On/Off key
- 2 Function display
- 3 Current time indicator field
- 4 Oven inner temperature symbol
- 5 Temperature indicator field
- 6 Start/stop cooking key

- 7 Temperature/power setting key
- 8 Booster symbol (Quick preheating)
- 9 Plus key
- 10 Minus key
- 11 Setting key
- 12 Return to function display key

Package contents



Accessories supplied can vary depending on the product model. Not every accessory described in the user manual may exist on your product.

1. **User manual**
2. **Standard tray**

Used for pastries, frozen foods and big roasts.

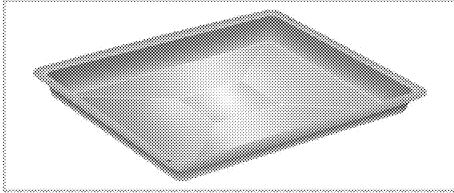

3. **Wire Shelf**

Used for roasting and for placing the food to be baked, roasted or cooked in casserole dishes to the desired rack.

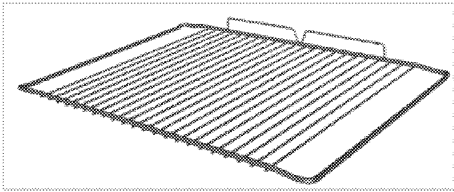

4. **Small wire shelf**

It is placed into the tray (if supplied) in order to collect the dripping fat while grilling so that the oven is kept clean.

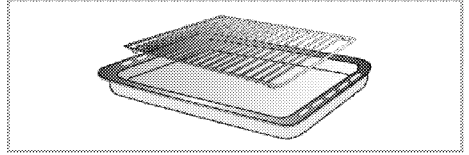

Technical specifications

GENERAL	
Voltage / frequency	220-240 V ~ 50 Hz
Total power consumption	2.7 kW
Fuse	16 A
Cable type / section	H05W-FG 3 x 1,5 mm ² or equivalent
Cable length	max. 2 m
OVEN/GRILL	
External dimensions (height / width / depth)	455 mm/594 mm/567 mm
Installation dimensions (height / width / depth)	**450 or 460 mm/560 mm/min. 550 mm
Main oven	Multifunction oven
Inner lamp	15/25 W
Grill power consumption	2.0 kW
MICROWAVE	
Net volume	40 lt
Microwave power	Max. 800 W
Microwave frequency	2465 MHz

Basics: Information on the energy label of electrical ovens is given in accordance with the EN 60350-1 / IEC 60350-1 standard. Those values are determined under standard load with bottom-top heater or fan assisted heating (if any) functions.

Energy efficiency class is determined in accordance with the following prioritization depending on whether the relevant functions exist on the product or not. 1-Cooking with eco-fan, 2- Turbo slow cooking, 3- Turbo cooking, 4- Fan assisted bottom/top heating, 5-Top and bottom heating.

** See. *Installation*, page 16.



Technical specifications may be changed without prior notice to improve the quality of the product.



Figures in this manual are schematic and may not exactly match your product.



Values stated on the product labels or in the documentation accompanying it are obtained in laboratory conditions in accordance with relevant standards. Depending on operational and environmental conditions of the product, these values may vary.

3 Installation

Product must be installed by a qualified person in accordance with the regulations in force. The manufacturer shall not be held responsible for damages arising from procedures carried out by unauthorized persons which may also void the warranty.



	Preparation of location and electrical installation for the product is under the installer's responsibility.
	DANGER: The product must be installed in accordance with all local electrical regulations.
	DANGER: Prior to installation, visually check if the product has any defects on it. If so, do not have it installed. Damaged products cause risks for your safety.

Before installation

The appliance is intended for installation in commercially available kitchen cabinets. A safety distance must be left between the appliance and

the kitchen walls and furniture. See figure (values in mm).

- Surfaces, synthetic laminates and adhesives used must be heat resistant (100 °C minimum).
- Kitchen cabinets must be set level and fixed.
- If there is a drawer beneath the oven, a shelf must be installed between oven and drawer.
- Carry the appliance with at least two persons.

	Do not install the appliance next to refrigerators or freezers. The heat emitted by the appliance will lead to an increased energy consumption of cooling appliances.
	The door and/or handle must not be used for lifting or moving the appliance.
	If the appliance has wire handles, push the handles back into the side walls after moving the appliance.

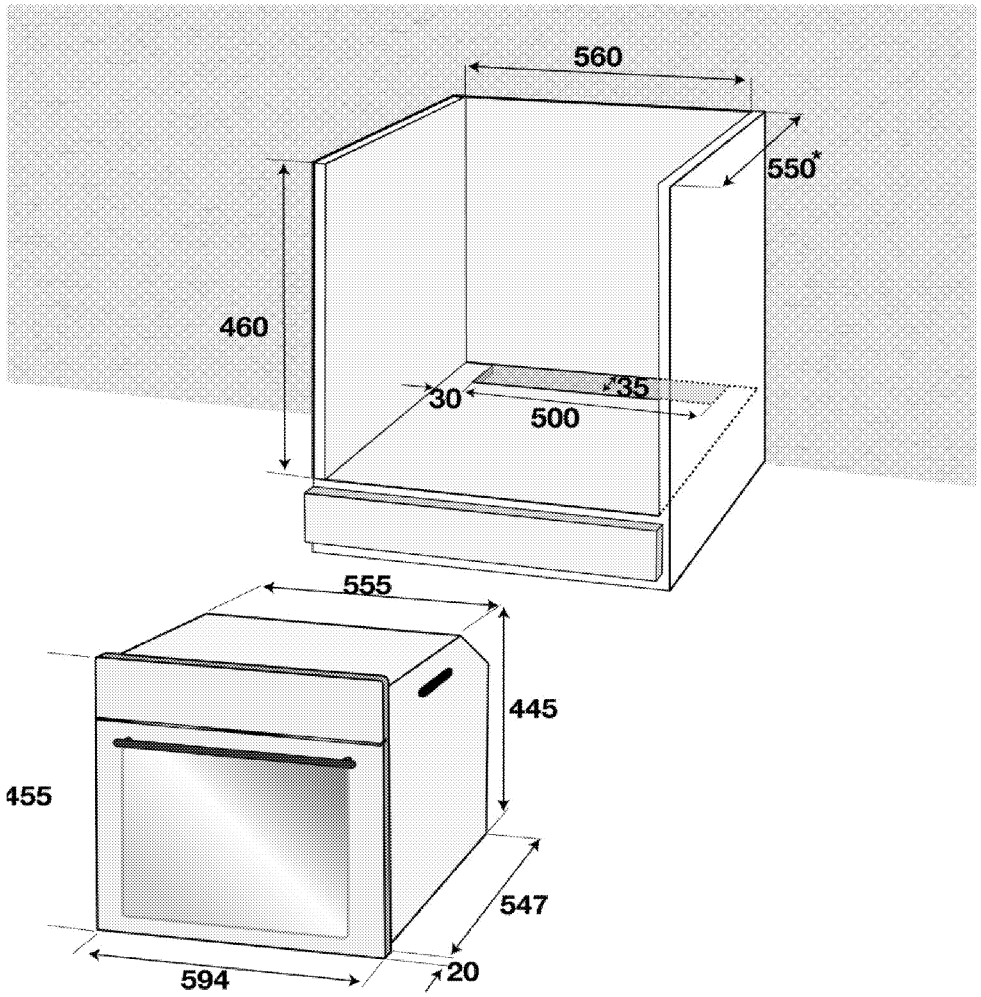

* min.

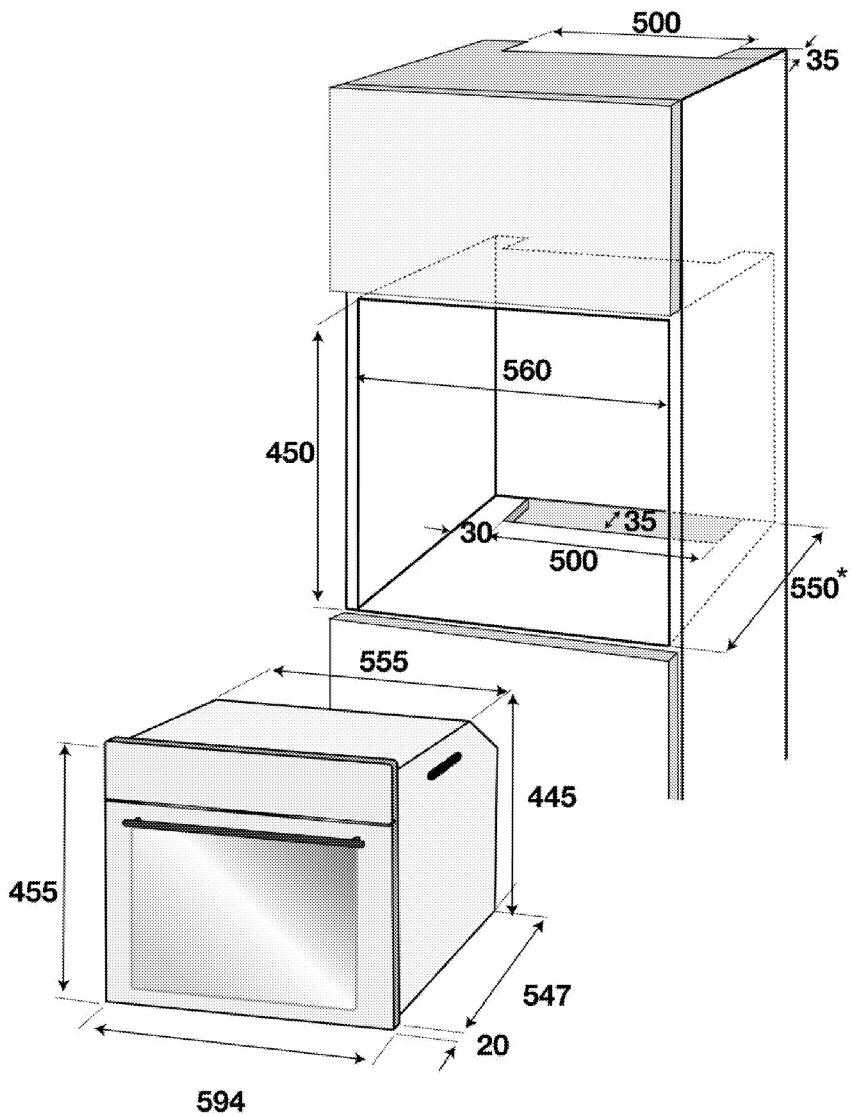

* min.

Installation and connection

- Product can only be installed and connected in accordance with the statutory installation rules.

Electrical connection

Connect the product to a grounded outlet/line protected by a fuse of suitable capacity as stated in the "Technical specifications" table. Have the grounding installation made by a qualified electrician while using the product with or without a transformer. Our company shall not be liable for any damages that will arise due to using the product without a grounding installation in accordance with the local regulations.



DANGER:

The product must be connected to the mains supply only by an authorised and qualified person. Manufacturer shall not be held responsible for damages arising from procedures carried out by unauthorised persons.



DANGER:

The power cable must not be clamped, bent or trapped or come into contact with hot parts of the product. A damaged power cable must be replaced by a qualified electrician. Otherwise, there is risk of electric shock, short circuit or fire!

- Connection must comply with national regulations.
- The mains supply data must correspond to the data specified on the type label of the product. Open the front door to see the type label.
- Power cable of your product must comply with the values in "Technical specifications" table.



DANGER:

Before starting any work on the electrical installation, disconnect the product from the mains supply. There is the risk of electric shock!

Connecting the power cable

1. If a power cable is not supplied together with your product, a power cable that you

would select from the table (*Technical specifications, page 14*) in accordance with the electrical installation at your home must be connected to your product by following the instructions in cable diagram.

This product must only be connected by a qualified electrician such as a technician from the local electricity company or NICEIC registered contractor to a suitable double-pole control unit with a minimum contact clearance of 3 mm in all poles. This control unit must be installed accordance with the IEE regulation. Failure to obey this instruction may cause operational problems and invalidate the product warranty.



Additional protection by a residual current circuit breaker is recommended.

2. Open the terminal block cover with a screwdriver.
3. Insert the power cable through the cable clamp below the terminal and secure it to the main body with the integrated screw on cable clamping component.
4. Connect the cables according to the supplied diagram.

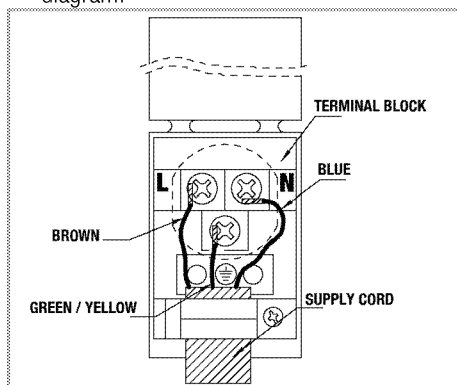

5. After completing the wire connections, close the terminal block cover.
6. Route the power cable so that it will not contact the product and get squeezed between the product and the wall.



Power cable must not be longer than 2 m because of safety reasons.

Installing the product

1. Slide the oven into the cabinet, align and secure it while making sure that the power cable is not broken and/or trapped.

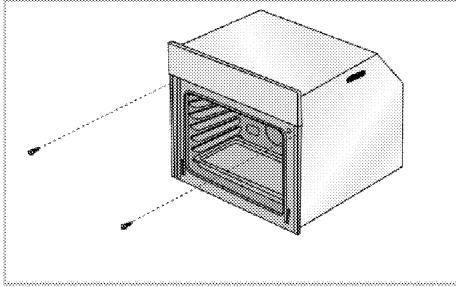

Secure the oven with 2 screws as illustrated.

For products with cooling fan

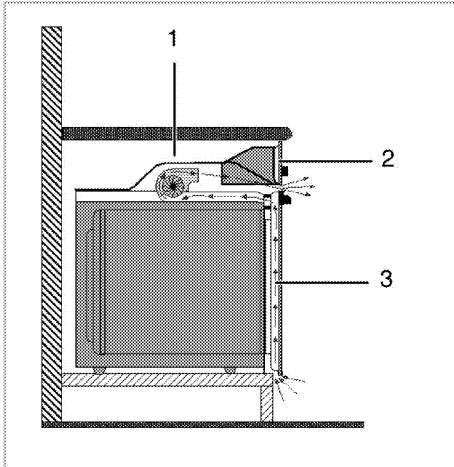

- 1 Cooling fan
- 2 Control panel
- 3 Door

3 Door

The built-in cooling fan cools both the built-in cabinet and the front of the product.

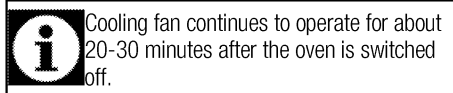

Final check

1. Connect the power cable and switch on the product's fuse.
2. Check the functions.

Future Transportation

- Keep the product's original carton and transport the product in it. Follow the instructions on the carton. If you do not have the original carton, pack the product in bubble wrap or thick cardboard and tape it securely.
- To prevent the wire grill and tray inside the oven from damaging the oven door, place a strip of cardboard onto the inside of the oven door that lines up with the position of the trays. Tape the oven door to the side walls.
- Do not use the door or handle to lift or move the product.

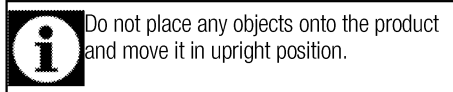

4 Preparation

Tips for saving energy

The following information will help you to use your appliance in an ecological way, and to save energy:

- Use dark coloured or enamel coated cookware in the oven since the heat transmission will be better.
- While cooking your dishes, perform a preheating operation if it is advised in the user manual or cooking instructions.
- Do not open the door of the oven frequently during cooking.

- Try to cook more than one dish in the oven at the same time whenever possible. You can cook by placing two cooking vessels onto the wire shelf.
- Cook more than one dish one after another. The oven will already be hot.
- You can save energy by switching off your oven a few minutes before the end of the cooking time. Do not open the oven door.
- Defrost frozen dishes before cooking them.

Initial use

Day time setting

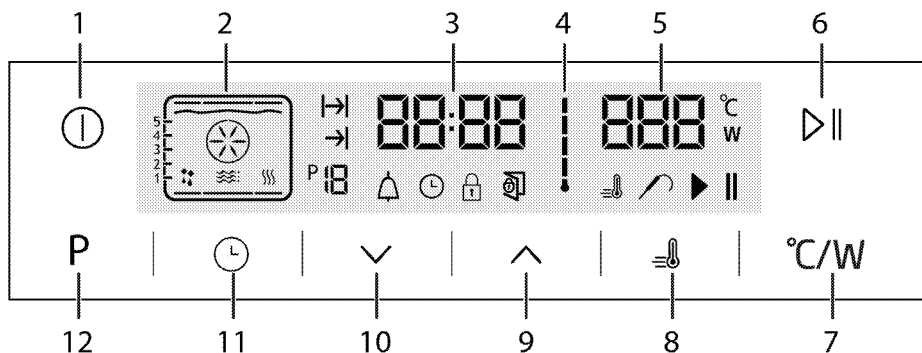

- 1 On/Off key
 - 2 Function display
 - 3 Current time indicator field
 - 4 Oven inner temperature symbol
 - 5 Temperature indicator field
 - 6 Start/stop cooking key
 - 7 Temperature/power setting key
 - 8 Booster symbol (Quick preheating)
 - 9 Plus key
 - 10 Minus key
 - 11 Setting key
 - 12 Return to function display key
1. At the initial operation of the oven symbol lights up; touch / keys to set the hour.
 2. Confirm the setting by touching symbol and wait for 4 seconds without touching any keys to confirm.

If the current time is not set, time indicator will start increasing/moving up from **12:00**. symbol will be activated to indicate that the current time has not been set. It will disappear as soon as the time is set.

First cleaning of the appliance



The surface might get damaged by some detergents or cleaning materials.

Do not use aggressive detergents, cleaning powders/creams or any sharp objects during cleaning.

Do not use harsh abrasive cleaners or sharp metal scrapers to clean the oven door glass since they can scratch the surface, which may result in shattering of the glass.

1. Remove all packaging materials.
2. Wipe the surfaces of the appliance with a damp cloth or sponge and dry with a cloth.

Initial heating

Heat up the product for about 30 minutes and then switch it off. Thus, any production residues or layers will be burnt off and removed.



WARNING

Hot surfaces cause burns!

Product may be hot when it is in use. Never touch the hot burners, inner sections of the oven, heaters and etc. Keep children away. Always use heat resistant oven gloves when putting in or removing dishes into/from the hot oven.

Electric oven

1. Take all baking trays and the wire grill out of the oven.
2. Close the oven door.
3. Select the highest oven power.
4. Operate the oven for about 30 minutes.
5. Turn off your oven.

Grill oven

1. Take all baking trays and the wire grill out of the oven.
2. Close the oven door.
3. Select the highest grill power; see *How to operate the grill, page 39*
4. Operate the grill about 15 minutes.
5. Turn off your grill; see *How to operate the grill*



Smoke and smell may emit for a couple of hours during the initial operation. This is quite normal. Ensure that the room is well ventilated to remove the smoke and smell. Avoid directly inhaling the smoke and the smell that emits.

5 How to operate the microwave

General information on microwave cooking

To prevent overflowing when heating water and other liquids in your microwave oven:

3. Do not use closed containers, or containers with narrow openings.
 4. Do not overheat.
 5. Before placing the container in the microwave, stir the contents with a teaspoon and then open the door and restir when it is half done. Do not leave the teaspoon inside while the oven is operating.
 6. When heating liquids such as soups and sauces, these may unexpectedly bubble up and overflow before they even come to the boil. Do not leave your oven unattended when heating such liquids.
- After warming baby food or drink inside a feeding bottle, shake and test the temperature before giving to your baby. Before heating, remove the cap and mouthpiece from the bottle.
 - Remove food from any plastic packaging before cooking or defrosting. Under certain exceptional circumstances, you may be required to cover food with a special nylon clinging film.
 - Do not use your product for making popcorn unless you have specially designed bags for use in microwave ovens.
 - Chocolate sweets with low liquid content and flour-based foods should be heated with caution.
 - Eggs in their shell and whole hardboiled eggs should not be heated in microwave ovens since they may explode even after microwave heating has ended.

Containers suitable for microwaving

Microwaves pass through porcelain, glass, cardboard or plastic but not the metals. Therefore metal utensils or utensils with metal parts cannot be used in microwave oven.

Microwaves are reflected by metal...

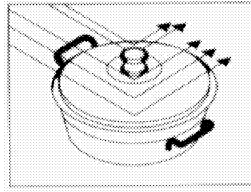

... but they pass through glass or porcelain...

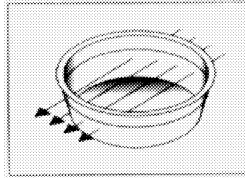

... and absorbed by the foods.

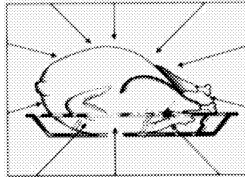

	CAUTION Fire risk! Never place metal or metal-covered containers in your microwave oven.
	CAUTION Do not use your oven when empty and without tray. This can damage the oven.

- Microwaves cannot penetrate metal. Microwaves will reflect off any metal objects in the oven causing dangerous electric arcing. Most heatproof non-metallic containers are suitable for use in a microwave oven. However, certain containers may contain materials that are unsuitable for microwaving. You can apply the following test to determine whether a container is suitable for microwaving or not:
 - Place the container you wish to test empty in the oven along with another container filled with water.

- Operate the oven at high power for one minute. If the water has been heated and the container you are testing is cold, then it is suitable for microwaving.
- On the other hand, if the water remains cold and the neighboring container heats up, this means that the microwaves have been absorbed by the container and therefore subject container is unsuitable for microwaving.

Glass containers

- Avoid using containers made of very thin glass or lead crystal. Heatproof glass containers are suitable for use in microwave ovens. On the other hand, in the microwave oven avoid using brittle glass containers such as water and wine glasses that may break as their contents heat up.

Plastic containers

- Do not use pots and dishes made of plastic or melamine for long duration microwaving; the same applies for bags used for storing frozen food. This is because very hot food will sooner or later cause the plastic containers to melt or distort. Use such containers only for short duration microwaving.

Cooking bags

- Cooking bags are suitable for use in microwave ovens, provided that these are designed for cooking. Do not forget to pierce them to enable the steam inside to

escape. Never use normal plastic bags for cooking purposes since they will melt and break up.

Paper

- You should not use any kind of paper for long-duration cooking. This will cause the paper to catch fire. Paper dishes are suitable for oily and dry foods that require short-duration cooking.

Do not use recycled paper. Such paper may contain fragments that can cause arcing.

Wooden and wicker containers

- As microwave causes drying of wooden structure and crisp it, large wooden containers should not be used.

Porcelain containers

- Generally speaking, containers made of such materials are suitable for use in a microwave oven, but you should test them to be sure.

Metal containers

- Metal containers reflect the microwaves away from the food. Therefore, avoid using such containers.



DANGER:

Certain cookware containing high levels of iron or lead are unsuitable for use as cooking containers.

Make sure that you test your cookware in terms of suitability for microwaving.

Cookware	Microwave	Grill	Convection	Combination modes
Heat-Resistant Glass	Yes	Yes	Yes	Yes
Non Heat-Resistant Glass	No	No	No	No
Heat-Resistant Ceramics	Yes	Yes	Yes	Yes
Microwave-Safe Plastic Plate	Yes	No	No	No
Kitchen Paper	Yes	No	No	No
Metal Tray	Yes*	Yes	Yes	Yes*
Metal Rack	No	Yes	Yes	No
Aluminum Foil & Foil Container	No	Yes	Yes	No
* Only use metal tray given with oven.				

Positioning food

- You will obtain optimal results by arranging the food evenly in the container. This method can be applied in many ways for satisfactory results.
- You can cook a large number of identical pieces (for example potatoes). If you arrange them in an evenly spaced circle around the oven they will cook better. Avoid placing one piece on another.
- Since the microwaves act more powerfully on the outer layers of food, when cooking pieces of food with different shapes and thicknesses, place the thick parts in the centre of the tray. This will ensure that these parts are cooked first.
- Place fish and other food that is not flat with their tails at the edge of the tray.
- You can place very finely carved pieces of meat on top of each other. Thicker items such as sausages and meat slices should be placed close together.
- Heat gravy and sauces in a separate dish. Narrow, deep dishes are better for this purpose than wide, shallow ones. Containers should be no more than two thirds full when you heat gravy, sauces or soups.
- If you are cooking fish whole, pierce them so that their skins do not burst.
- When using clinging film, bags or baking paper, pierce or leave an opening to enable steam to escape.
- Small pieces of food will cook quicker than large pieces, and evenly shaped pieces will cook quicker than other pieces. For the best results cut food evenly into pieces of equal size.

Food height

- With food that is quite thick (generally roasts), the lower part will cook faster. This means that it is sometimes necessary to turn such items over several times.
- Thick or dense items can be placed in a higher position, enabling the microwaves to

act on the bottom and middle parts of the item.

Cooking suggestions

Factors affecting microwaving time :

- Microwaving time depends on a number of factors. The temperature of the ingredients used in a recipe can considerably affect the amount of cooking time required. Thus, a cake made with ice-cold butter, milk and eggs will take considerably longer to cook than one made with ingredients at room temperature.
- Particularly when it comes to bread, cakes and cream sauces, you are recommended with certain recipes to remove the food from the oven before it is fully cooked. Such foods if left covered outside the oven will continue to cook as heat flows from the outer to the inner layers of the food.

If you leave items on the oven until they are fully done, you risk burning the outer layer. With time you will become a better judge of how long items require to be cooked and left to stand.

- Do not leave items to cook unattended. Your microwave oven is automatically lit up when it is in operation, enabling you to keep an eye on the condition of the items being cooked.

Defrosting:

- The defrosting time may depend on the shape of the packet. Shallow, rectangular packets defrost more quickly than deep containers.
- Separate the items as they start to defrost. They will then defrost more readily.
- The more food you cook, the longer it will take. Twice the amount of food will take roughly twice as long. If it takes four minutes to cook one potato, it will take on average seven minutes to cook two potatoes.

The amount of microwaves that your oven produces remains constant however much food you place inside it. This means that the

more food you place inside, the longer it will take to do.

Liquid content

- Liquid content affects cooking time because microwaves are sensitive to moisture. Foods with natural liquid content (such as vegetables, fish, and poultry) will cook quickly and easily. When cooking dry items such as rice and pulses you are recommended to add water.
- Remember that moisture is eliminated in a microwave oven, so that when cooking drier items such as certain vegetables you should first wet them with a little water or cover them so that they retain their moisture.
- When cooking foods with very little water content (thawing bread, making pop-corns) evaporation takes place rapidly. In such cases oven operates as if it is empty and foods can get burnt. And oven or the utensils can get damaged. Therefore, make sure that you just set the required cooking time and never leave the oven unattended during cooking.

Steam

- The moisture within the food may sometimes cause the oven to steam up when it is operating. This is normal.

Sugar

- When making foods with very high sugar content like puddings and tarts, follow the recommendations in your microwave recipe books.

If you exceed the recommended cooking time, this may result in the food burning or damage to your oven.

Food density

- Light, porous items such as bread and cakes will take less time than heavy, dense items such as roasts and stews. Exercise caution when microwaving porous items since they do not have hard, dry surfaces.

Bones and fat content

- Bones conduct heat and fat cooks faster than meat. When cooking pieces of meat containing bones or fat, ensure that they are cooked evenly and not overcooked.

Food colour

- Meat or poultry that has been cooked for fifteen minutes or more will brown gently in its own fat. To give food that has been prepared quickly a more appetizing and roast complexion, you can cover it with barbecue or soy sauce. If you only use a little of this sauce it will not affect the essential flavor of the food.

Reducing the internal pressure in food

- Many kinds of foods are covered in skins. Steam builds up inside as they are cooked which may cause them to burst. To avoid this, the skin should be pierced with a fork or knife. You should apply this procedure with potatoes, chicken livers, mussels, egg yolks, sausages and certain kinds of fruit and vegetable.

Turning and stirring items while cooking

- It is important to stir items when you are microwaving them. In conventional cooking food is stirred to mix it. In microwave cooking, however, food is stirred to achieve equal heat distribution. Always stir from the outside towards the middle because the outside heats up before the middle.
- With bulky and elongated items like roasts and whole poultry, you should turn them over to ensure that the top and bottom are equally cooked. Indeed, you may have to turn sliced meat and chicken over.
- Turning items over and stirring whilst cooking are important to ensure that all sides are equally well done.

Different cooking times

- To begin with, always try out the minimum cooking time and check whether the item is done. The cooking times given in this manual are approximate values. Cooking times may vary according to the dimensions and types of the food and containers.

Standing time

- Leave the food to stand for a while after removing from the oven. When defrosting, cooking and reheating, leaving the items to stand for a while invariably produces better

results. This is because the heat will spread evenly around the food.

Inside the microwave oven, food will continue to cook even after the oven has been turned off. The standing period will raise the heat of the food by between 3°C and 8°C. This process is maintained not by the microwave oven but by the heat within the food. The standing time may vary according to the kind of food. Sometimes this period is as short as the time taken to remove the food from the oven and serve it. This period may extend to as long as ten minutes with large items.

- Remove food from its plastic packaging before cooking or defrosting. Under certain exceptional circumstances it may be necessary to cover your food with a special clinging, nylon film.
- It is especially recommended with items like meat, chicken, bread, cakes and cream sauce to remove them from the oven before they are fully cooked and leave them to stand until fully cooked.

Your microwave oven operates in 3 different principles, namely, only microwave, only oven function, and combined mode.

Operating mode	Description
Microwave	When the oven operates in microwave mode only, it creates heat directly inside the meal. You may use the microwave for warming meals or drinks, thawing or cooking. In microwave, meals are cooked but not roasted.
Oven function	Only the oven heaters cook the meal by heating it up. You may use the oven for all kinds of cooking and also for thawing. Meals are both cooked and roasted in the oven function.
Combined mode	In the combined mode, both the oven heaters and the microwave operate concurrently. Meals are cooked and roasted in a shorter time in the combined mode.

How to use the microwave oven



Before you can use the oven, the time must be set. If the time is not set, oven will not operate.

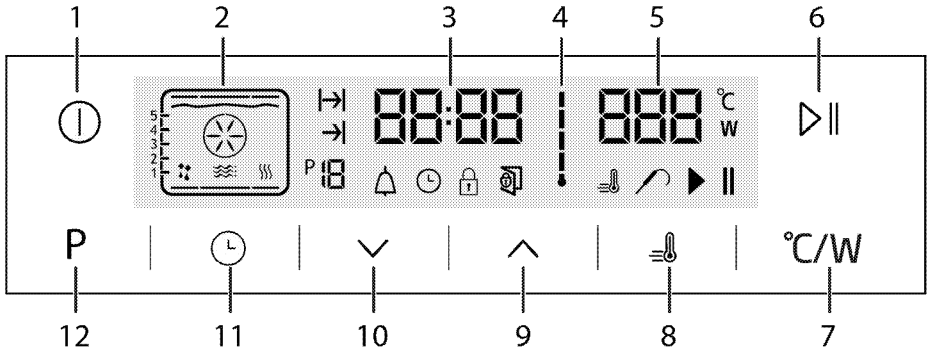

- 1 On/Off key
- 2 Function display
- 3 Current time indicator field
- 4 Oven Inner Temperature symbol
- 5 Temperature indicator field
- 6 Start/stop cooking key
- 7 Temperature/power setting key
- 8 Booster symbol (rapid preheating)
- 9 Plus key
- 10 Minus key
- 11 Adjustment key
- 12 Return to function display key

- : Cooking time symbol
- : End of cooking time symbol
- : Function number
- : Alarm symbol
- : Clock symbol
- : Key lock symbol
- : Open door warning symbol
- : Booster symbol (rapid preheating)
- : Meat probe symbol
- : Cooking position symbol
- : Cooking in progress symbol

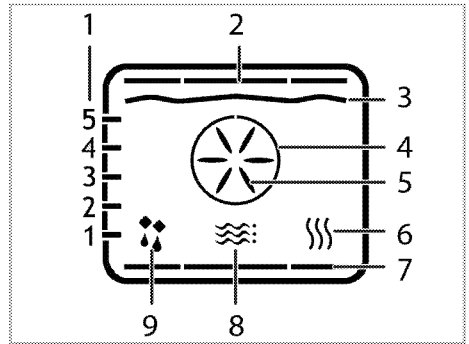

- 1 Rack positions
- 2 Top heater
- 3 Grill heater
- 4 Turbo heater
- 5 Boost fan
- 6 Warm keeping
- 7 Bottom heating
- 8 Microwave symbol
- 9 Operating with fan position

Functions vary depending on the product model!

Function table:

Function table indicates the operating functions that can be used in the oven and their respective maximum and minimum temperatures.

Oven returns to stand-by display after it is switched on and the current time is set. Only the current time appears on the display.

Operating in microwave mode

1. Touch  to switch on the oven.
2. Initial operation screen appears when the oven is switched on.

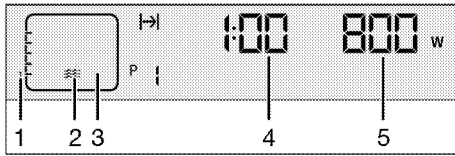

- 1 Rack positions
- 2 Microwave symbol
- 3 Function display
- 4 Cooking time field: Indicates the set cooking time.
- 5 Microwave power/Temperature indicator field

This screen contains microwave mode with the microwave power level, recommended rack position and cooking time.

3. If you want to change the microwave power level, touch $^{\circ}\text{C}/\text{W}$ once to reach the power setting display.

W symbol will flash.

4. Touch \swarrow/\searrow until the desired power level appears in the power level field. Touch $^{\circ}\text{C}/\text{W}$ to set the level when the desired value appears on the display.
5. For cooking duration, touch L once. \rightarrow symbol will flash as well.
6. Touch \swarrow/\searrow to select the desired cooking time and confirm the setting with L . Once the cooking time is set, \rightarrow will be displayed continuously.

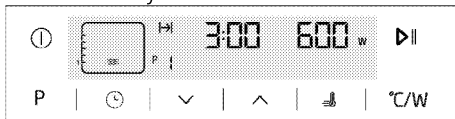

7. If cooking time and power level values are suitable, touch \triangleright to start cooking. Cooking starts.

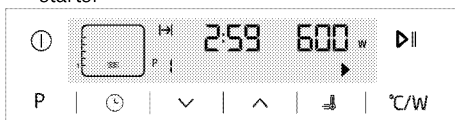

i If the oven door is opened during cooking, \parallel appears on the display and microwave cooking is cancelled. You must touch \triangleright again to resume cooking after closing the oven door.

» The oven will operate on the level set, until the end of the cooking time you selected. The oven lamp is lit during the cooking process.

8. After the cooking is completed, "End" and

\parallel symbol appear on the display and alarm signal is heard.

9. To stop the alarm signal, just touch any key.

Operating in combi mode (oven and microwave together)

1. Touch L to switch on the oven.
2. Touch \wedge or \vee to select the desired combi mode.

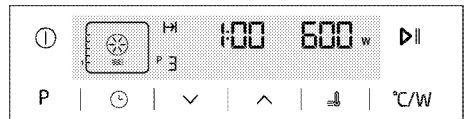

3. If you want to change the microwave power level, touch $^{\circ}\text{C}/\text{W}$ once to reach the power setting display.

W symbol will flash.

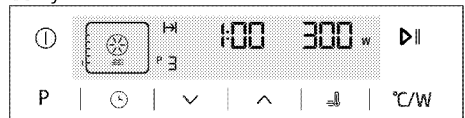







4. Touch \swarrow/\searrow until the desired power level appears in the power level field. Touch $^{\circ}\text{C}/\text{W}$ to set the level when the desired value appears on the display.

5. If you want to change the temperature in combi mode, touch $^{\circ}\text{C}/\text{W}$ twice to reach the temperature setting display.

$^{\circ}\text{C}$ symbol will flash.



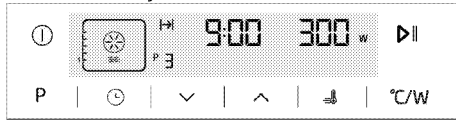

6. Touch \swarrow/\searrow until the desired temperature appears in the temperature indicator field. Touch $^{\circ}\text{C}/\text{W}$ to set the temperature when the desired value appears on the display.

- For cooking duration, touch  once.  symbol will flash as well.
- Touch   to select the desired cooking time and confirm the setting with . Once the cooking time is set,  will be displayed continuously.

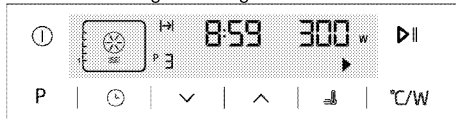

- If the cooking time, power level and temperature values are suitable, touch  to start cooking. Cooking starts.



i If the oven door is opened during cooking,  appears on the display and microwave cooking is cancelled. You must touch  again to resume cooking after closing the oven door.

» The oven will be heated up to the preset temperature and will maintain this temperature until the end of the cooking time you selected. At the same time the oven will continue to run at the set microwave power level. The oven lamp is lit during the cooking process.

- After the cooking is completed, **"End"** and  symbol appear on the display and alarm signal is heard.

- To stop the alarm signal, just touch any key.

i During cooking, microwave level and cooking time can be changed.

i For microwave functions, oven clock displays cooking time in minutes and seconds format.

i In microwave cooking alone or combi mode cooking at low temperatures, odour may remain after taking out the food since the oven will be cold while cooking takes place. In such a case, operate your oven in fan assisted cooking mode at 230 °C for 20 minutes.

Switching off the electric oven

Touch  to switch off the oven.

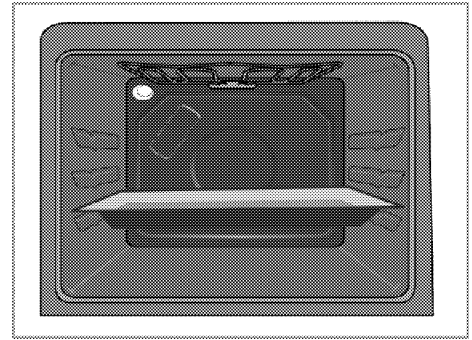

First rack of the oven is the bottom rack. **Use only the first rack for microwave cooking.**

i Due to safety reasons, maximum time that can be set for "Cook time" is limited with 12 minutes at highest power level. On other power levels, this time may reach to 90 minutes.

i While making any setting, related symbols will flash on the display.

i Programme will be cancelled if a power failure occurs. You need to program the oven again.

i Current time cannot be set if the oven is operating at any function.

i Even if the oven is switched off, oven lamp lights up when the oven door is opened.

Operating modes for microwave

The order of operating modes shown here may vary according to the arrangement on your product.



Cooking with several racks in microwave and combi modes is not possible. They are suitable for cooking with one rack only.



Oven is not heated in microwave mode alone. Only the food is heated.

Microwave

Only the microwave operates. It may be used to warm meals and drinks, as well as cooking. Meals are cooked without roasting.



Microwave+Fan Heating

Oven's rear heater also operates together with the microwave. Hot air heated by the rear heater is evenly distributed throughout the oven rapidly by means of the fan. You can cook your meals in a short time and roast at the same time.

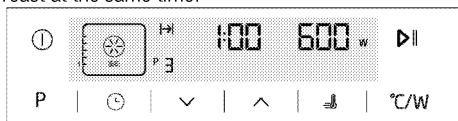

Microwave+Full Grill

Microwave and the grill on the ceiling of the oven operate. It is suitable for grilling large amount of meat.

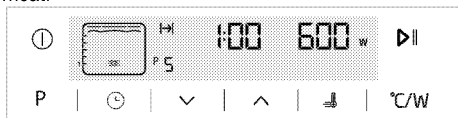

- Put big or medium-sized portions in correct rack position under the grill heater for grilling.
- Turn the food after half of the grilling time.

Microwave+Full Grill+Fan

Microwave and hot air heated by the full grill is distributed very fast in the oven by means of the fan. It is suitable for grilling large amount of meat.

Microwave+Full Grill+Fan

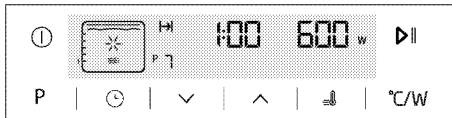

- Put big or medium-sized portions in correct rack position under the grill heater for grilling.
- Turn the food after half of the grilling time.

Microwave+Defrost

Microwave and only the fan (on the rear wall) operate.

It is suitable for thawing frozen grained food at room temperature slowly and cooling down the cooked food.

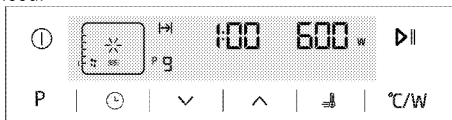

Function table

Function table indicates the functions that can be used in microwave and combi modes and their respective maximum and minimum temperatures.



Power values in Watt for microwave are 100,200,300,600 and 800.

Function	Power range (W)	Temperature range (°C)
Microwave	100-800	-
Microwave+Fan Heating	100-600	50-280
Microwave+Full Grill	100-600	50-280
Microwave+Full Grill+Fan	100-600	50-280
Microwave+Defrost	100-600	-

Cooking times table



The timings in this chart are meant as a guide. Timings may vary due to temperature of food, thickness, type and your own preference of cooking.



1st rack of the oven is the bottom rack. Use only 1st rack in microwave cooking.

Dish	Cooking mode	Weight (gr)	Temperature (°C)	Microwave power (W)	Cooking time (approx. in min.)
Chicken baguette	Microwave+Fan supported	1000	210	600	25-30
Whole chicken	Microwave+Fan supported	1500	15 min. 230 then 200	600	32-38
Frozen pizza	Microwave+Fan supported	450	230	200	6-10
Turkey, thigh (boned)	Microwave+Grill+Fan	1000	230	300	28-32
Fresh large potatoes	Microwave+Fan supported	1000	180	600	25-30
Potatoes graten *	Microwave+Fan supported	1250	180	600	25-30
Dalyan meatball	Microwave+Fan supported	100	5 min. 230 then 170	300	18-23
Whole fish	Microwave+Grill+Fan	1000	250	600	8-14
Sticks of fish pane	Microwave+Fan supported	600	230	300	10-15
Dumplings with tomato and potato	Microwave+Fan supported	1500	210	200	32-40
Convenience food (Chickpea with meat)	Microwave	400		600	3-5
Pilaf	Microwave	400	-	600	3-5

Please make preheating before cooking in combi mode. Preheating should be made by oven operating modes.

* It is suggested to add planed kashar cheese onto it during the final 5 minutes of cooking.

Defrost

Dish	Weight (gr)	Microwave power (W)	Dissolution time (min.) (approximately)	Waiting time (min.)	Suggestions
All red meat	250	200	5-7	10	Turn over half way through the cooking time
	500	200	11-14	10	Turn over half way through the cooking time
Ground meat	100	100	6-10	10	
	250	200	4-7	10	
	500	200	6.5-8	10	Turn over half way through the cooking time
Whole chicken	1500	200	24-27	10	Turn over half way through the cooking time
Chicken legs	750	300	5-8	10	
Chicken baguette	500	300	4-7	10	
	100	600	5-8	10	
Whole fish	250	200	5-9	5	Turn over half way through the cooking time
	500	200	8-12	5	Turn over half way through the cooking time
Sausage	300	200	4-8	5	

6 How to operate the oven

General information on baking, roasting and grilling



WARNING

Hot surfaces cause burns!

Product may be hot when it is in use. Never touch the hot burners, inner sections of the oven, heaters and etc. Keep children away. Always use heat resistant oven gloves when putting in or removing dishes into/from the hot oven.



DANGER:

Be careful when opening the oven door as steam may escape. Exiting steam can scald your hands, face and/or eyes.

Tips for baking

- Use non-sticky coated appropriate metal plates or aluminum vessels or heat-resistant silicone moulds.
- Make best use of the space on the rack.
- Place the baking mould in the middle of the shelf.
- Select the correct rack position before turning the oven or grill on. Do not change the rack position when the oven is hot.
- Keep the oven door closed.

Tips for roasting

- Treating whole chicken, turkey and large piece of meat with dressings such as lemon juice and black pepper before cooking will increase the cooking performance.
- It takes about 15 to 30 minutes longer to roast meat with bones when compared to roasting the same size of meat without bones.
- Each centimeter of meat thickness requires approximately 4 to 5 minutes of cooking time.
- Let meat rest in the oven for about 10 minutes after the cooking time is over. The juice is better distributed all over the roast and does not run out when the meat is cut.

- Fish should be placed on the middle or lower rack in a heat-resistant plate.

Tips for grilling

When meat, fish and poultry are grilled, they quickly get brown, have a nice crust and do not get dry. Flat pieces, meat skewers and sausages are particularly suited for grilling as are vegetables with high water content such as tomatoes and onions.

- Distribute the pieces to be grilled on the wire shelf or in the baking tray with wire shelf in such a way that the space covered does not exceed the size of the heater.
- Slide the wire shelf or baking tray with grill into the desired level in the oven. If you are grilling on the wire shelf, slide the baking tray to the lower rack to collect fats. Add some water in the tray for easy cleaning.



Foods that are not suitable for grilling carry the risk of fire. Only grill food which is suitable for intensive grilling heat.

Do not place the food too far in the back of the grill. This is the hottest area and fatty food may catch fire.

How to operate the electric oven



Functions vary depending on the product model.





Maximum adjustable cooking time in modes except "warm keeping" and microwave functions is limited with 6 hours due to safety reasons.



While adjusting any function, related symbols will flash on the display.



Program will be cancelled in case of power failure. You must reprogram the oven.

-  Current time cannot be set while the oven is operating in any function, or if semi-automatic or full automatic programming is made on the oven.
-  Even if the oven is switched off, oven lamp lights up when the oven door is opened.
-  Oven clock displays cooking durations for cooking with oven functions in hours and minutes, except for microwave functions.

Recommended temperature is displayed when the function is selected.

Function	Temperature range (°C)
Fan heating	40-280
Full grill	40-280
Low grill	40-280
Eco fan heating	160-220
Warm keeping	40-100
* Functions vary depending on the product model.	

Operating modes

The order of operating modes shown here may be different from the arrangement on your product.

Fan heating

Hot air heated by the rear heater is evenly distributed throughout the oven rapidly by means of the fan. It is suitable for cooking your meals in different rack levels and preheating is not required in most cases.

Suitable for cooking with multi trays.



-  When the oven door is opened, the fan motor will not run in order to keep the hot air inside.

Full grill

Large grill at the ceiling of the oven is in operation. It is suitable for grilling large amount of meat.

Full grill



- Put big or medium-sized portions in correct rack position under the grill heater for grilling.
- Turn the food after half of the grilling time.

Low grill

Small grill at the ceiling of the oven is in operation. Suitable for grilling and gratin dishes.



- Put small or medium-sized portions in correct rack position under the grill heater for grilling.
- Turn the food after half of the grilling time.

Eco fan heating

To save power, you can use this function instead of the cooking operations that you would perform by using Fan Heating at 160-220°C temperature range. However, the cooking time will increase a little bit. Cooking times related to this function are indicated in "Eco Fan Heating" table.

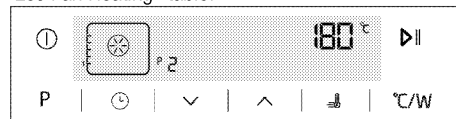

Warm keeping

Used for keeping food at a temperature ready for serving for a long period of time.



How to operate the oven control unit

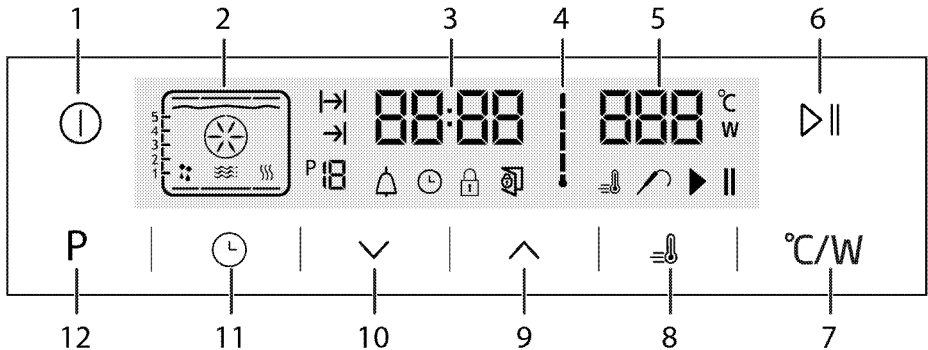

- 1 On/Off key
- 2 Function display
- 3 Current time indicator field
- 4 Oven Inner Temperature symbol
- 5 Temperature indicator field
- 6 Start/stop cooking key
- 7 Temperature/power setting key
- 8 Booster symbol (rapid preheating)
- 9 Plus key
- 10 Minus key
- 11 Adjustment key
- 12 Return to function display key

- : Cooking time symbol
- : End of cooking time symbol
- : Function number
- : Alarm symbol
- : Clock symbol
- : Key lock symbol
- : Open door warning symbol
- : Booster symbol (rapid preheating)
- : Meat probe symbol
- : Cooking position symbol
- : Cooking in progress symbol

How to operate the oven

1. Touch the "⏻" key for approx. 2 seconds to open the oven.
- » First operating function appears on display after the oven is turned on. When the display is in this mode, cooking time, the end of cooking time and Booster (quick heating) function can be set.

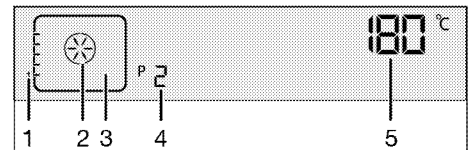









- 1 Rack positions
- 2 Function display
- 3 Function symbol
- 4 Function number
- 5 Temperature/weight indicator field

Oven will switch off automatically within 20 seconds if no oven setting is made on this screen.

Manual cooking by selecting temperature and operating function





You can cook by selecting temperature and operating function specific to your meal and check progress manually without setting the cooking duration.









1. First operating function appears on display after touching ⏻ button to open the oven.
2. Select the operating function by touching the keys.

3. If you desire to change the temperature that is recommended for operating function, enable the temperature field by touching °C/W button.
 - » °C symbol flashes.
4. Set the desired temperature by touching   keys.
5. Confirm the temperature setting by touching °C/W key.
6. Put your dish into the oven.
7. Touch   key to start cooking if temperature and operating function are appropriate.  symbol appears on display.
 - » Your oven will readily start operating in the selected function and will increase the inner temperature to the set temperature. Each grades of the inner temperature symbol will be lit as inner temperature reaches to the set temperature. Additional active heaters and recommended tray position appear in the Function display.
8. The oven does not turn off automatically due to the manual cooking without setting the cooking time. You can finish cooking by touching   key once again.
 - » The oven finishes the cooking and  symbol appears on display.
9. Touch the "  " key for approx. 2 seconds to close the oven.

Cooking by setting the cooking time;



You can make your oven switch off automatically at the end of cooking duration by selecting the temperature and function specific to your meal and setting the cooking duration.

1. First operating function appears on display after touching  button to open the oven.
2. Select the operating function by touching the   keys.
3. If you desire to change the temperature that is recommended for operating function, enable the temperature field by touching °C/W button.
 - » °C symbol flashes.
4. Set the desired temperature by touching   keys.
5. Confirm the temperature setting by touching °C/W key.

6. Touch  until  symbol appears on display for cooking time.
7. Set the cooking time by touching   keys and confirm the setting by touching  key.
 - » Once the Cooking Time is set,  symbol will appear on display continuously.
8. Put your dish into the oven.
9. Touch   key to start cooking if temperature, operating function and cooking time are appropriate.  symbol appears on display.
 - » The oven will be heated up to the set temperature and will maintain this temperature until the end of the cooking time you selected.
 - » Your oven will readily start operating in the selected function and will increase the inner temperature to the set temperature. It maintains this temperature until the end of the set cooking time. Each grades of the inner temperature symbol will be lit as inner temperature reaches to the set temperature. Additional active heaters and recommended tray position appear in the Function display.
10. After the cooking process is completed, "End" appears on the display and the alarm sounds.
11. Touch any key to silence the alarm.
 - » Alarm stops and the oven finishes operating automatically.

Setting the end of cooking time to a later time;



You can ensure that the oven runs and turns off automatically by setting temperature and operating function specific to your meal, the cooking time and end of cooking to a later time, manually controlling without setting the cooking duration.



1. First operating function appears on display after touching  button to open the oven.
2. Select the operating function by touching the   keys.
3. If you desire to change the temperature that is recommended for operating function, enable the temperature field by touching °C/W button.

» °C symbol flashes.



4. Set the desired temperature by touching   keys.



5. Confirm the temperature setting by touching °C/W key.

6. Touch  until  symbol appears on display for cooking time.

7. Set the cooking time by touching   keys and confirm the setting by touching  key.



» Once the Cooking Time is set,  symbol will appear on display continuously.

8. Touch  until  symbol appears on display for the end of cooking time.

9. Set the cooking time by touching   buttons and confirm the setting by touching  key.

» Once the end of cooking time is set,  symbol will appear on display continuously.

10. Put your dish into the oven.

11. Touch   key to start cooking if temperature, operating function, cooking time and the end of cooking time are appropriate.  symbol appears on display.

» Oven timer automatically calculates the startup time for cooking by deducting the cooking time from the end of cooking time you have set.

Selected operation mode is activated when the startup time of cooking has come and the oven is heated up to the set temperature. It maintains this temperature until the end of the set cooking time. Each grades of the inner temperature symbol will be lit as inner temperature reaches to the set temperature. Additional active heaters and recommended tray position appear in the Function display.

12. After the cooking process is completed, "End" appears on the display and the alarm sounds.

13. Touch any key to silence the alarm.

» Alarm stops and the oven finishes operating automatically.



If you want to cancel only cooking time or cooking time plus the end of cooking time after you have set them, you need to reset the cooking time.

Setting the booster (Quick Pre-heating)

Use Booster (Rapid Pre-heating) function to make the oven reach the desired temperature faster.





Booster cannot be selected in defrosting, keeping warm and cleaning positions. Booster settings will be cancelled in case of power failure.

1. Touch  after setting the temperature, operating function, cooking time and the end of cooking time.

»  symbol appears continuously and booster (rapid pre-heating) setting is enabled.

» Booster symbol disappears as soon as the oven reaches the desired temperature and oven resumes operating in the function it was in before the Booster function.

2. Touch  again in order to cancel booster function.



»  symbol disappears and booster (rapid pre-heating) setting is disabled.

Switching off the electric oven



Touch  to switch off the oven.

Activating the key lock

You can prevent oven from being intervened with by activating the key lock function.

1. Touch  until  symbol appears on display. » "OFF" appears on the display.



2. Press  to activate the key lock.



» Once the key lock is activated, "On" appears on the display and the  symbol remains lit. Confirm by touching .



Oven keys are not functional when the key lock is activated. Key lock will not be cancelled in case of power failure.

Deactivating the key lock

1. Touch  until  symbol appears on display. » "On" will appear on the display.

2. Disable the key lock by pressing the  key. » "OFF" will appear once the key lock is deactivated. Confirm by touching  key.



Oven keys are not functional when the Key lock function is activated. Key lock settings will not be cancelled in case of power outage.

Setting the alarm clock





You can use the timer of the product for any warning or reminder apart from the cooking program.

The alarm clock has no influence on the functions of the oven. It is only used as a warning. For example, this is useful when you want to turn food in the oven at a certain point of time. Timer will give an audio warning at the end of the set time.

1. Touch  until  symbol appears on display.





Maximum alarm time can be 23 hours and 59 minutes.

2. Set the alarm duration by using  /  keys.
»  symbol will remain lit and the alarm time will appear on the display once the alarm time is set.
3. At the end of the alarm time,  symbol starts flashing and the audio warning is heard.

Silencing the alarm

1. Audio warning sounds for 2 minutes. To stop the audio warning, just press any key.
» Audio warning will be silenced and current time will be displayed.





Cancelling the alarm;

1. Touch  until  symbol appears on display in order to cancel the alarm.
2. Press and hold  key until "00:00" is displayed.



Alarm time will be displayed. If the alarm time and cooking time are set concurrently, shortest time will be displayed.





Changing the time of the day

1. Touch  in short intervals until  symbol appears on display.
2. Touch  /  keys to set the hour.
3. Confirm the setting by touching  symbol and wait for 4 seconds without touching any keys to confirm.









Current time settings are cancelled in case of power failure. It needs to be readjusted. Current time can not be changed when any of the oven functions is in use.

Adjusting the volume

1. While the oven is in Standby mode, touch  key in short intervals until 'VOL' appears on display.
2. Press  /  keys to set one of L0, L1 or L2 tones.
3. Press  key or wait for 4 seconds without touching any keys to confirm the setting.

Adjusting the Eco lamp setting

1. While the oven is in Standby mode, touch  key in short intervals until 'LP' appears on display.
2. Press  /  keys to set On or ECO option.
3. Press  key or wait for 4 seconds without touching any keys to confirm the setting.
4. When set to ON; while the oven door is open in Standby mode and during operation the lamp is turned ON continuously.
5. When set to ECO; while the oven door is open in Standby mode and during operation the lamp is turned ON and then turned OFF after 15 seconds.

If any key is touched during operation (excluding  and  keys) the lamp is turned ON and then turned OFF after 15 seconds.

Cooking times table



The values specified have been determined in the lab. The values suitable for you may be different from these values.

Baking and roasting



1st rack of the oven is the **bottom** rack.

Dish	Cooking level number	Accessory to use	Operating mode	Rack position	Temperature (°C)	Cooking time (approx. in min.)
Cakes in tray	One level	Standard tray*		1	175	30 ... 40
Cakes in mould	One level	Cake mold on wire grill**		1	175	50 ... 60
Small cakes	One level	Standard tray*		1	150	35 ... 45
Sponge cake	One level	Round springform pan with a diameter of 26 cm on wire grill**		1	150	25 ... 35
Walnut cookies	One level	Pastry tray*		1	175	25 ... 30
	2 levels	1-Pastry tray* 3-Standard tray*		1 - 3	170 ... 180	35 ... 45
Dough pastry	One level	Standard tray*		1	200	35 ... 45
	2 levels	1-Pastry tray* 3-Standard tray*		1 - 3	200	45 ... 55
Rich pastry	One level	Standard tray*		1	190	25 ... 35
	2 levels	1-Pastry tray* 3-Standard tray*		1 - 3	190	35 ... 45
Leaven	One level	Standard tray*		1	200	35 ... 45
Lasagna	One level	Glass/metal rectangular pan on wire grill*		1	200	30 ... 40
Beef steak (whole) / Roast	One level	Standard tray*		1	25 min., 250/max, then 180 ... 190	100 ... 120
Leg of Lamb (casserole)	One level	Standard tray*		1	25 min at 220 and then 180 ... 190	70 ... 90
Roasted chicken	One level	Standard tray*		1	15 min., 250/max, then 190	55 ... 65
Turkey (Sliced)	One level	Standard tray*		1	25 min., 250/max, then 190	150 ... 210
Fish	One level	Standard tray*		1	200	20 ... 30

It is suggested to perform preheating for all foods.

* These accessories may not be supplied with the product.

** These accessories are not supplied with the product. They are commercially available accessories.

Eco Fan Heating



Do not change the cooking temperature after cooking starts in Eco Fan Heating mode.



Do not open the door in Eco Fan Heating mode.

Dish	Cooking level number	Accessory to use	Operating mode	Rack position	Temperature (°C)	Cooking time (approx. in min.)
Small cakes	One level	Standard tray*		1	160	20 ... 30
Walnut cookies	One level	Standard tray*		1	200	30 ... 35
Dough pastry	One level	Standard tray*		1	200	40 ... 45
Rich pastry	One level	Standard tray*		1	200	40 ... 45

* These accessories may not be supplied with the product.

Tips for baking cake

- If the cake is too dry, increase the temperature some 10°C and decrease the cooking time.
- If the cake is too dark on top, place it on a lower rack, lower the temperature and increase the cooking time.

- If cooked well on the inside but sticky on the outside use less liquid, lower the temperature and increase the cooking time.

Tips for baking pastry

- If the pastry is too dry, increase the temperature some 10°C and decrease the cooking time. Dampen the layers of dough with a sauce composed of milk, oil, egg and yoghurt.
- If the pastry takes too long to bake, pay care that the thickness of the pastry you have prepared does not exceed the depth of the tray.
- If the upper side of the pastry gets browned, but the lower part is not cooked, make sure that the amount of sauce you have used for the pastry is not too much at the bottom of the pastry. Try to scatter the sauce equally between the dough layers and on the top of the pastry for an even browning.



Cook the pastry in accordance with the mode and temperature given in the cooking table. If the bottom part is still not browned enough, place it on one lower rack next time.

Tips for cooking vegetables

- If the vegetable dish runs out of juice and gets too dry, cook it in a pan with a lid instead of a tray. Closed vessels will preserve the juice of the dish.
- If a vegetable dish does not get cooked, boil the vegetables beforehand or prepare them like canned food and put in the oven.

Operating the grill



WARNING













Close oven door during grilling.
Hot surfaces may cause burns!

Cooking times table for grilling

Grilling with electric grill

Food	Insertion level	Recommended temperature (°C)**	Grilling time (approx.)
Fish	2..3	250	20..25 min. #
Sliced chicken	2..3	250	25..35 min.
Lamb chops	2..3	250	20..25 min.
Roast beef	2..3	250	25..30 min. #
Veal chops	2..3	250	25..30 min. #
Toast bread	3	250	1..2 min.
* depending on thickness			

Switching on the grill

1. First operating function appears on display after touching  button to open the oven.
2. Touch   keys to select the desired grill function.
3. If you desire to change the temperature that is recommended for operating function, enable the temperature field by touching  button.
 - »  symbol flashes.
4. Set the desired temperature by touching   keys.
5. Confirm the temperature setting by touching  button.
6. Touch  key to start grilling if temperature and operating function are appropriate.  symbol appears on display.
 - » Your oven will readily start operating in the selected function and will increase the inner temperature to the set temperature. Each grades of the inner temperature symbol will be lit as inner temperature reaches to the set temperature. Additional active heaters and recommended tray position appear in the Function display.
7. You can finish grilling by touching  button once again.
 - » The oven finishes grilling and  symbol appears on display.

Switching off the grill

1. Touch the  button for approx. 2 seconds to close the oven.

7 Maintenance and care

General information

Service life of the product will extend and the possibility of problems will decrease if the product is cleaned at regular intervals.



DANGER:

Disconnect the product from mains supply before starting maintenance and cleaning works.

There is the risk of electric shock!



DANGER:

Allow the product to cool down before you clean it.

Hot surfaces may cause burns!

- Clean the product thoroughly after each use. In this way it will be possible to remove cooking residues more easily, thus avoiding these from burning the next time the appliance is used.
- No special cleaning agents are required for cleaning the product. Use warm water with washing liquid, a soft cloth or sponge to clean the product and wipe it with a dry cloth.
- Always ensure any excess liquid is thoroughly wiped off after cleaning and any spillage is immediately wiped dry.
- Do not use cleaning agents that contain acid or chloride to clean the stainless or inox surfaces and the handle. Use a soft cloth with a liquid detergent (not abrasive) to wipe those parts clean, paying attention to sweep in one direction.



The surface might get damaged by some detergents or cleaning materials.

Do not use aggressive detergents, cleaning powders/creams or any sharp objects during cleaning.

Do not use harsh abrasive cleaners or sharp metal scrapers to clean the oven door glass since they can scratch the surface, which may result in shattering of the glass.



Do not use steam cleaners to clean the appliance as this may cause an electric shock.

Cleaning microwave oven part

- If steam accumulates inside or around the outside of the oven door, wipe with a soft cloth. This may occur when the microwave oven is operated under high humidity condition. And it is normal.
- Remove odors from your oven by combining a cup of water with the juice and skin of one lemon in a deep microwaveable bowl and microwave for 5 minutes. Wipe thoroughly and dry with a soft cloth.
- When it becomes necessary to replace the oven light, please consult an Authorized Service Agent to have it replaced.
- The oven should be cleaned regularly and any food deposits should be removed. Failure to maintain the oven in a clean condition could lead to deterioration of the surface that could adversely affect the life of the product and possibly result in a hazardous situation.
- Please do not dispose this product together with the domestic wastes. It should be disposed to the particular disposal center provided by the municipalities.



Be careful not to damage the door seal when cleaning the oven door. Do not operate the oven with damaged door seal.

Cleaning the control panel

Clean the control panel and control knobs with a damp cloth and wipe them dry.



Do not remove the control buttons/knobs to clean the control panel.

Control panel may get damaged!

Cleaning the oven

Clean oven door

To clean the oven door, use warm water with washing liquid, a soft cloth or sponge to clean the product and wipe it with a dry cloth.

i Don't use any harsh abrasive cleaners or sharp metal scrapers for cleaning the oven door. They could scratch the surface and destroy the glass.

Replacing the oven lamp

! **DANGER:**
Before replacing the oven lamp, make sure that the product is disconnected from mains and cooled down in order to avoid the risk of an electrical shock. Hot surfaces may cause burns!

i In this oven, an incandescent lamp with a power of less than 40 W, a height of less than 60 mm, a diameter of less than 30 mm or a halogen lamp with socket type G9, a power of less than 60 W is used. The lamps are suitable for operation at temperatures above 300 °C. Oven lamps can be obtained from Authorised Service Agents or technician with licence.

i Position of lamp might vary from the figure.

i The lamp used in this appliance is not suitable for household room illumination. The intended purpose of this lamp is to assist the user to see foodstuffs.

i The lamps used in this appliance have to withstand extreme physical conditions such as temperatures above 50 °C.

If your oven is equipped with a round lamp:

1. Disconnect the product from mains.
2. Turn the glass cover counter clockwise to remove it.

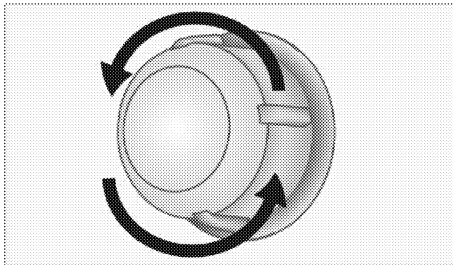

3. If your oven lamp is of type (A) shown in the figure below, remove it by rotating as shown and replace it. If it is of type (B), pull and remove it as shown in the figure and replace it.

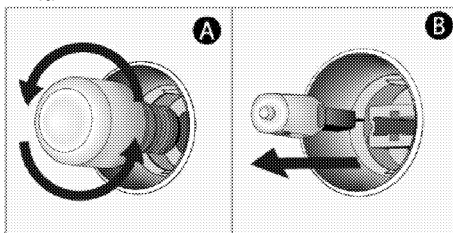

4. Install the glass cover.

8 Troubleshooting

Oven emits steam when it is in use.

- It is normal that steam escapes during operation. >>>*This is not a fault.*

Product emits metal noises while heating and cooling.

- When the metal parts are heated, they may expand and cause noise. >>>*This is not a fault.*

Product does not operate.

- The mains fuse is defective or has tripped. >>>*Check fuses in the fuse box. If necessary, replace or reset them.*
- Product is not plugged into the (grounded) socket. >>>*Check the plug connection.*
- Buttons/knobs/keys on the control panel do not function. >>>*Keylock may be enabled. Please disable it. (See.)*

Oven light does not work.

- Oven lamp is defective. >>>*Replace oven lamp.*
- Power is cut. >>>*Check if there is power. Check the fuses in the fuse box. If necessary, replace or reset the fuses.*

Oven does not heat.

- Function and/or Temperature are not set. >>>*Set the function and the temperature with the Function and/or Temperature knob/key.*
- Power is cut. >>>*Check if there is power. Check the fuses in the fuse box. If necessary, replace or reset the fuses.*

There is no response when I keep the keys/buttons pressed for a long time

- Do not operate the oven. Switch off the circuit breaker and unplug the appliance. Call the Authorised Service Agent.

Microwave does not operate.

- Product is not plugged into the socket properly >>>*Insert the plug into the socket.*
- Door is not closed properly. >>>*Door should "click" while closing.*
- There can be an obstacle between the door and the front section of the oven. >>>*Remove the obstacle and close the door properly.*

Some strange noises are heard when the microwave is in operation.

- There is an electrical arc inside the oven resulting from a foreign metal object. >>>*Remove the metal object from the oven cavity.*
- Oven accessories contact the oven walls. >>>*Avoid the contact with the oven door.*
- There are loose cutlery items or cooking utensils inside the oven. >>>*Remove the cutlery item or cooking utensil from the oven cavity.*

Food is not heated or heated too slow.

- Correct operation time and/or power level are not selected. >>>*Select the suitable cooking power and time for your food.*
- Amount of the food can be larger than normal or it may be colder than the normal level. >>>*Set additional cooking time. Check regularly to prevent the food from burning.*
- There are loose cutlery items or cooking utensils inside the oven. >>>*Remove the cutlery item or cooking utensil from the oven cavity.*

Food is too hot, dry or burnt.

- Correct operation time and/or power level are not selected. >>>*Check whether you have selected the suitable cooking power and time for your food. Call Authorised Service Agent if your oven is damaged.*

Some noises are heard after the cooking time is over.

- Cooling fan may be in operation. >>>*This is not a fault. Cooling fan continues to operate after the oven is switched off. Fan will stop automatically when the temperature decreases to a certain level.*



Consult the Authorised Service Agent or the dealer where you have purchased the product if you can not remedy the trouble although you have implemented the instructions in this section. Never attempt to repair a defective product yourself.

9 Guarantee Details

BEKO UK AND IRELAND STANDARD MANUFACTURER GUARANTEE TERMS AND CONDITIONS

Your new Beko product is guaranteed against faulty materials, defective components or manufacturing defects.

The standard guarantee starts from the date of original purchase of the product, and lasts for a period of twelve (12) months unless Beko plc (the "Manufacturer") agrees to extend the guarantee for the product in writing.

If you have purchased an American style Fridge freezer, the standard guarantee starts from the date of original purchase of the product, and lasts for a period of twenty four (24) months unless Beko plc (the "Manufacturer") agrees to extend the guarantee for the product in writing.

If you have any questions about the guarantee on your product (including how long it is valid), please contact your retailer or our contact centre on **0333 207 9710** (UK and Northern Ireland) or 01 862 3411 (Republic of Ireland)

This guarantee does not in any way diminish or affect your statutory rights in connection with the product. This guarantee is in addition to your statutory rights as a consumer. If you have any questions about these rights, please contact the retailer from which you purchased the product. In certain circumstances, it is possible that your statutory rights may offer additional or higher levels of protection than those offered under the terms of this guarantee.

What is covered by this guarantee?

- Repairs to the product required as a result of faulty materials, defective components or manufacturing defects.
- Functional replacement parts to repair a product.
- The costs of a Beko Approved Engineer to carry out the repair.

What is not covered?

- Transit and delivery damage.
- Cabinet or appearance parts, including but not limited to control knobs, flaps and handles.
- Accessories and/or consumable items including but not limited to ice trays, scrapers, cutlery baskets, filters and light bulbs.
- Repairs necessary as a direct or indirect result of:
 - Accidental damage, misuse or abuse of a product.
 - An attempted repair of a product by anyone other than a Beko Approved Engineer (the "Engineer").
 - Installation or use of a product where such installation or use fails to meet the requirements contained in this guarantee or the User Instructions Booklet.
- Repairs to a product operated at any time on commercial or non-residential household premises (unless we have previously agreed to the installation environment).

This guarantee is limited to the cost of repairing the product. To the extent permitted by law, the Manufacturer does not accept and will not be held liable for any financial loss incurred in connection with the failure of any product to operate in accordance with the expected standards. Such financial loss includes but is not limited to loss arising from:

- Time taken off work.
- Damaged food, clothing or other items.
- Meals taken at restaurants or from takeaways.
- General compensation for inconvenience.

Important Notes

1. Your product is designed and built for domestic household use only.
2. The guarantee will automatically be void if the product is installed or is used in commercial or non-residential domestic household premises, unless we have previously agreed to the installation environment.
3. The product must be correctly installed, located and operated in accordance with the instructions contained in the User Instructions Booklet provided with your product.
4. Professional installation by a qualified Electrical Domestic Appliance Installer is recommended for all Washing Machines, Dishwashers and Electric Cookers (as incorrect installation may result in you having to pay for the cost of repairing the product).
5. Gas Cookers must be professionally installed by a Gas Safe (or Gas Networks Ireland for Republic of Ireland) registered gas installer.
6. This guarantee is given in respect of products purchased and used within the United Kingdom and the Republic of Ireland.
7. This guarantee is effective from the initial date of purchase of a new product from an authorised retailer and will be void if the product is resold.
8. This guarantee does not apply to graded sales (where the product is purchased as a "second").
9. Possession of a copy of these terms and conditions does not necessarily mean that a product has the benefit of this guarantee. If you have any questions, please call our Call Centre on the number set out above.
10. The Manufacturer reserves the right to terminate the guarantee if its staff or representatives are subjected to physical or verbal abuse in the course of carrying out their duties.
11. Optional extras, where available (i.e. extendable feet) are supplied on a chargeable basis only.

Does Beko offer replacements?

This is a repair-only guarantee. On occasion, the Manufacturer may at its sole discretion, replace your product with a new product instead of carrying out a repair. Where a replacement is offered, this would normally be an identical model but when this is not possible, a model of similar specification will be provided. The Manufacturer will cover the costs and arrange for the delivery of the new product and for the return of the old product. Any costs related to disconnecting the faulty product and installing the replacement product will not be borne by the Manufacturer unless previously agreed to in writing. The original guarantee will continue to apply to the replacement product; the new product will not come with a new guarantee.

When will the repair take place?

Our Engineers work Monday to Friday 9.00am to 5.00pm. Appointments outside these hours may be possible at the sole discretion of the Manufacturer but cannot be guaranteed. Whilst our Engineers will endeavour to minimize inconvenience and to meet requests for specific timed appointments, this cannot be guaranteed. We will not be liable for delays or if it is unable to carry out a repair because a convenient appointment cannot be arranged.

Will there be any charge for the repairs?

It is your responsibility to provide evidence to the Engineer that your product is covered by this guarantee with a proof of purchase. The Manufacturer reserves the right to charge for the reasonable cost of any service call if:

- You cannot provide evidence that your product is covered by this guarantee.
- Where a service call has been made and the engineer finds that there is no fault with your product.
- That your product has not been installed or operated in accordance with the User Instructions Booklet.
- That the fault was caused by something other than faulty materials, defective components or manufacturing defects.
- For missed appointments.

Payment of these costs are due immediately upon the Engineer providing you with an invoice. The Manufacturer reserves the right to terminate the guarantee if you fail to pay the costs for the service call in a timely manner.

If you are a resident of the United Kingdom, this guarantee will be governed by English law and subject to the English Courts, save where you live in another part of the United Kingdom, in which case the law and courts of that location will apply.

If you are resident in the Republic of Ireland, this guarantee will be governed by Irish law and the Irish courts will have jurisdiction.

This guarantee is provided by Beko plc. Beko House, 1 Greenhill Crescent, Watford, Hertfordshire. WD18 8QU.

Beko plc is registered in England and Wales with company registration number 02415578.

BEKO UK AND IRELAND BUILT-IN APPLIANCES GUARANTEE TERMS AND CONDITIONS

If you have purchased a built-in or integrated appliance, and registered it within 90 days of purchase by completing the online registration form, then the standard 12 month guarantee will be extended to 24 months, under the same terms and conditions as detailed in our Standard Guarantee Terms and Conditions.

BEKO UK AND IRELAND PROSMART INVERTER MOTOR GUARANTEE TERMS AND CONDITIONS

This 10 year guarantee relates to Beko products that feature the ProSmart Inverter Motor.

The ProSmart Motor guarantee terms and conditions are in addition to our Standard guarantee terms and conditions detailed in the previous section.

In order to activate the 10 year guarantee you MUST register the appliance within 90 days of the original purchase date. You can register by first visiting Beko.co.uk/register and by following the online instructions.

Beko Free standing appliances come with a 12 month parts and labour guarantee as standard,

Beko Built-in appliances come with a 12 month parts and labour guarantee as standard. This is extended to 24 months, free of charge, upon registration of the appliance. When you register your appliance for additional guarantee, you will automatically activate the ProSmart Motor 10 year guarantee. You do not need to register twice. (beko.co.uk/guarantee-terms).

To make a claim against your Beko ProSmart Inverter Motor Guarantee (the "Guarantee"), all customer and product details must be registered with Beko plc using the procedure outlined below.

1. This extra 9 years (for free standing appliances) or 8 years (for built-in or integrated appliances) guarantee is only effective after the expiration of the standard manufacturer's guarantee.
2. It is only valid for the ProSmart Inverter motors of selected washing machines, washer-dryers, tumble dryers and dishwashers. It does not cover any labour charge or any other components of the product. In addition, it is only valid for one replacement of the ProSmart motor during the extra 9-year (for free standing appliances) or 8 year (for built-in appliances) guarantee period.
3. To activate your guarantee, you MUST register your appliance within 90 days of the original purchase date, by visiting beko.co.uk/register.
4. Customers will receive a unique reference code as proof of guarantee validation by email or post, which must be quoted at the time of a claim being made.
5. Any repair/replacement of the ProSmart Inverter motor must only be carried out by an authorised Beko Service Agent (the "Service Agent").
6. Labour for the repair/replacement of the ProSmart Inverter motor is not included in this guarantee and is chargeable directly by the Service Agent.
7. Any additional components fitted to the product at any time will not be covered by this guarantee and will be chargeable directly by the Service Agent.
8. The guarantee is not transferable and cannot be exchanged for cash.
9. There are no alternative or additional offers to this Guarantee.
10. The guarantee is exclusive of the manufacturer's standard guarantee.
11. The Terms and Conditions shown above are in addition to the standard terms and conditions of your product guarantee. Please read and refer to such Terms and Conditions when making any claim.

12. We may use the information you provide for marketing purposes and to analyse your purchasing preferences. We may keep your information for a reasonable period for these purposes in accordance with the applicable Data Protection Laws and General Data Protection Regulations (GDPR). You can opt into this service during the registration process. Further details are available at <http://www.beko.co.uk/cookie-and-privacy>.
13. These Terms and Conditions are governed by the laws of England and Wales; manufacturer: Beko plc, Beko House, 1 Greenhill Crescent, Watford WD18 8QU. Company Registration Number: 02415578.

HOW TO OBTAIN SERVICE FOR YOUR APPLIANCE

Please keep your purchase receipt or other proof of purchase details in a safe place; you will need to have this documentation available should the product require attention under guarantee.

Please take a few moments to complete the details below, as you will need this information when you call us, or to use our online services. When you call us you may be required to input your serial number into your telephone keypad. For help please visit beko.co.uk/support/model-finder

- The product model number is printed on the Operating Instruction Booklet / User guide
- The product model and serial number is printed on the Rating Label affixed to the appliance.
- The Retailer (Purchased from) and Date of purchase will be printed on your purchase receipt or other proof of purchase paperwork

Recording of these details alone will not count as proof of purchase. A valid proof of purchase is required for requesting service under guarantee.

Model number	Serial number	Purchased from	Date of purchase

For service under guarantee or for product advice please call our Contact centre

Before requesting service please check the troubleshooting guide in the Operating Instructions booklet, as a charge may be levied where no fault is found, and even though your product may still be under guarantee.

After arranging service the area around the product must be easily accessible to the Engineer, without the need for cabinets or furniture to be removed or moved.

It is your responsibility to ensure our Engineers have a clean and safe environment to carry out any repairs.

Please have your Model number and Serial number available when you call us, as you may be required to input your serial number into your telephone keypad during your call.

UK Mainland & Northern Ireland:

0333 207 9710

Landline or mobile calls to 0333 numbers cost no more than calls to geographic numbers 01 or 02, and are charged at the basic rate. Calls from landlines and mobiles are included in free call packages but please check with your telephone service provider for exact call charges.

Republic of Ireland:

01 862 3411

Service once the manufacturers guarantee has expired

If you have purchased an extended guarantee please refer to the instructions contained within the extended guarantee agreement document, otherwise please call us using the appropriate number above, where service can be obtained at a charge.

Should you experience any difficulty in obtaining service please call us on **0333 207 9710** or **01 862 3411**

Contact us through our website

Send us a secure message through our online contact us form. Please visit our website, click Contact Us and choose a product support topic from the list of options. Complete the required details and click send message.

Product registrations

For UK registrations please visit beko.co.uk/register and for the Republic of Ireland visit beko.ie/register.