



## Built-in Oven

User Manual



BBCW18400B  
BBCW12400X

385441425/ EN/ R.AA/ 19/04/2022 16:10  
7758089213-7758089212



## Welcome!

---

Dear Customer,

Thank you for choosing the Beko product. We want your product, manufactured with high quality and technology, to offer you the best efficiency. Therefore, carefully read this manual and any other documentation provided before using the product.

Keep in mind all the information and warnings stated in the user's manual. This way, you will protect yourself and your product against the dangers that may occur.

Keep the user's manual. If you give the product to someone else, give the manual with it. The warranty conditions, usage and troubleshooting methods for your product are provided in this manual.

### The symbols and their descriptions in the user's manual:



Hazard that may result in death or injury.



Important information or useful usage tips.



Read the user's manual.



Hot surface warning.

**NOTICE** Hazard that may result in material damage to the product or its environment.

**Arçelik A.Ş.**

Karaağaç caddesi No:2-6  
34445 Sütlüce/İstanbul/TURKEY

Made in TURKEY

## Table of Contents

<b>1 Safety Instructions</b>	<b>4</b>
1.1 Intended Use	4
1.2 Child, Vulnerable Person and Pet Safety	4
1.3 Electrical Safety	5
1.4 Microwave Safety	7
1.5 Transportation Safety	11
1.6 Installation Safety	12
1.7 Safety of Use	12
1.8 Temperature Warnings	12
1.9 Accessory Use	13
1.10 Cooking Safety	13
1.11 Maintenance and Cleaning Safety	14
<b>2 Environmental Instructions</b>	<b>14</b>
2.1 Waste Directive	14
2.1.1 Compliance with the WEEE Directive and Disposing of the Waste Product	14
2.2 Package Information	15
2.3 Recommendations for Energy Saving	15
<b>3 Your product</b>	<b>16</b>
3.1 Product Introduction	16
3.2 Product Control Panel Introduction and Usage	16
3.2.1 Control Panel	17
3.2.2 Introduction of the oven control panel	17
3.3 Oven operating functions	18
3.4 Product Accessories	20
3.5 Use of Product Accessories	21
3.6 Technical Specifications	23
<b>4 First Use</b>	<b>24</b>
4.1 First Timer Setting	24
4.2 Initial Cleaning	24
<b>5 Using the Oven</b>	<b>25</b>
5.1 General Information on Using the Oven	25
5.2 Operation of the Oven Control Unit	25
5.3 Settings	31
<b>6 General Information About Cooking</b>	<b>35</b>
6.1 General Warnings About Cooking in the Microwave Oven	35

6.2 General Warnings About Cooking in the Oven	40
6.2.1 Pastries and oven food	40
6.2.2 Meat, Fish and Poultry	42
6.2.3 Grill	43
6.2.4 Test foods	44
6.2.5 Microwave	45
<b>7 Maintenance and Cleaning</b>	<b>46</b>
7.1 General Cleaning Information	46
7.2 Cleaning Accessories	48
7.3 Cleaning the Control Panel	48
7.4 Cleaning the inside of the oven (cooking area)	48
7.5 Cleaning the Oven Lamp	48
<b>8 Troubleshooting</b>	<b>49</b>



## 1 Safety Instructions

---

- This section includes the safety instructions necessary to prevent the risk of personal injury or material damage.
- If the product is handed over to someone else for personal use or second-hand use purposes, the user's manual, product labels and other relevant documents and parts should also be given.
- Our company shall not be held responsible for damages that may occur if these instructions are not observed.
- Failure to follow these instructions shall void any warranty.
- Always have the installation and repair works made by the manufacturer, the authorised service or a person that the importer company shall designate.
- Use original spare parts and accessories only.
- Do not repair or replace any component of the product unless it is clearly specified in the user's manual.
- Do not make technical modifications on the product.



### 1.1 Intended Use

- This product is designed to be used at home. It is not suitable for commercial use.
- Do not use the product in gardens, balconies or other outdoors. This product is intended to be used in households and in the staff kitchens of shops, offices and other working environments.
- **WARNING:** This product should be used for cooking purposes only. It should not be used for different purposes, such as heating the room.
- The oven can be used to defrost, bake, fry and grill food.
- This product should not be used for heating, plate heating, drying by hanging towels or clothes on the handle.



### 1.2 Child, Vulnerable Person and Pet Safety

- This product can be used by children 8 years of age and older, and people who are underdeveloped in physical, sensory or mental skills, or who have lack of experience and knowledge, as long as

they are supervised or trained about the safe use and hazards of the product.

- Children should not play with the product. Cleaning and user maintenance should not be performed by children unless there is someone overseeing them.
- This product should not be used by people with limited physical, sensory or mental capacity (including children), unless they are kept under supervision or receive the necessary instructions.
- Children should be supervised to ensure that they do not play with the product.
- Electrical products are dangerous for children and pets. Children and pets must not play with, climb on, or enter the product.
- Do not put objects that children may reach on the product.
- **WARNING:** During use, the accessible surfaces of the product are hot. Keep children away from the product.
- Keep the packaging materials out of the reach of children. There is a hazard of injury and suffocation.

- When the door is open, do not put any heavy objects on it or allow children to sit on it. You may cause the oven to tip over or damage the door hinges.
- For the safety of children, cut the power plug and make the product inoperable before disposing the product.

### **1.3 Electrical Safety**

- Plug the product into a grounded outlet protected by a fuse that matches the current ratings indicated on the type label. Have the grounding installation made by a qualified electrician. Do not use the product without grounding in accordance with local / national regulations.
- The plug or the electrical connection of the product should be in an easily accessible place (where it will not be affected by the flame of the hob). If this is not possible, there should be a mechanism (fuse, switch, key switch, etc.) on the electrical installation to which the product is connected, in compliance with the electrical regulations and separating all poles from the network.

- The product must not be plugged into the outlet during installation, repair, and transportation.
  - Plug the product into an outlet that meets the voltage and frequency values specified on the type label.
  - If your product does not have a power cable, only use the power cable described in the "Technical specifications" section.
  - Do not jam the power cable under and behind the product. Do not put a heavy object on the power cable. The power cable should not be bent, crushed, and come into contact with any heat source.
  - The rear surface of the oven gets hot when it is in use. Power cords must not touch the back surface, connections may be damaged.
  - Do not jam the electric cables into the oven door and do not pass them over hot surfaces. Otherwise, cable insulation may melt and cause fire as a result of short circuit.
  - Use original cable only. Do not use cut or damaged cables or intermediate cables.
  - If the power cable is damaged, it must be replaced by the manufacturer, an authorized service or a person to be specified by the importer company in order to prevent possible dangers.
  - **WARNING:** Before replacing the oven lamp, be sure to disconnect the product from the mains supply to avoid the risk of electric shock. Unplug the product or turn off the fuse from the fuse box.
- If your product has a power cable and plug:
- Do not plug the product into an outlet that is loose, has come out of its socket, is broken, dirty, oily, with risk of water contact (for example, water that may leak from the counter).
  - Never touch the plug with wet hands! Never unplug by pulling on the cable, always pull out by holding the plug.
  - Make sure that the product plug is securely plugged into the outlet to avoid arcing.



## 1.4 Microwave Safety

- This appliances is intended to be used in household and similar applications such as:
  - staff kitchen areas in shops, offices and other working environments;
  - farm houses;
  - for clients in hotels, motels and other residential type environments;
  - for bed and breakfast type environments.
- Only allow children to use the oven without supervision when adequate instructions have been given so that the child is able to use the microwave oven in a safe way and understands the hazards of improper use.
- When the appliance is operated in the combination mode, children should only use the oven under adult supervision due to the temperature generated.
- The exposed parts of the product will become hot while and after the product is in use.
- Check the oven for any damage, such as misaligned or bent door, damaged door seals and sealing surface, broken or loose door hinges and latches and dents inside the cavity or on the door. If there is any damage, do not operate the oven and contact by the Authorised Service Agent.
- If the door or door seals are damaged, the oven must not be operated until it has been repaired by a competent person or Authorised Service Agent.
- Before operating your oven ensure that the door has been closed properly. A safety mechanism in the door lock prevents your appliance from operating when the door is open, halting the cooking operation if you open the door. You should not interfere with the door locking system or attempt to override this system. If the door locking system is overridden, risk of exposure to microwaves arises if the appliance is operated with an open door.
- Do not place any kind of object between the front of the oven and the door. You should not operate your oven

if objects such as paper towels or napkins prevent it from being closed properly.

- Radio Interference: Place the oven no less than 2 metres from TVs, radios, wireless modems, access points and aeri-als. Otherwise it may cause in-terference.
- Do not cook your meals with the cooking time and mi-crowave power set excess-ively high. Excessive cooking may desiccate, burn or ignite some parts of the meal.
- Never use aluminum folio or aluminum utensils for mi-crowave cooking.
- Do not use metal objects closer than 3 cm to the oven door while cooking with mi-crowave.
- Do not place corrosive chem-icals or materials containing corrosive vapor into the oven.

**When there is interference, it may be reduced or elimin-ated by taking the following measures:**

- Clean door and sealing sur-face of the oven.
- Reorient the receiving antenna of radio or television.

- Relocate the microwave oven with respect to the receiver.
- Move the microwave oven away from the receiver.
- Plug the microwave oven into a different outlet so that mi-crowave oven and receiver are on different branch circuits.
- Place the oven away from other heating appliances and avoid using it in damp or steamy environments.
- It is hazardous for anyone other than a competent per-son or the Authorised Service Agent to carry out any service or repair operation that in-volves the removal of a cover which gives protection against exposure to microwave en-ergy.
- This product is a Group 2 Class B ISM equipment. The definition of Group 2 which contains all ISM (Industrial, Scientific and Medical) equip-ment in which radio-frequency energy is intentionally gener-ated and/or used in the form of electromagnetic radiation for the treatment of material, and spark erosion equipment. For Class B equipment is equipment suitable for use in



domestic environments and in establishments directly connected to a low voltage power supply network which supplies buildings used for domestic purpose.

- The microwave oven is intended for heating food and beverages. Drying of food or clothing and heating or warming pads, slippers, sponges, damp cloth and similar may lead to risk of injury, ignition or fire.
- Your oven has not been designed for drying any living beings.
- Do not operate your oven when it is empty. This may damage the oven. Should you wish to test the oven, place a glass of water inside. The water will absorb the microwave energy and the oven will suffer no damage.
- Only use utensils that are suitable for use in microwave ovens.
- Do not use earthenware containers for microwave cooking. Moisture in the earthenware may expand and cause cracking of your container.

### **To reduce the risk of fire in the oven cavity:**

- When heating food in plastic or paper containers, keep an eye on the oven due to the possibility of ignition. If smoke is observed, switch off or unplug the appliance and keep the door closed in order to stifle any flames.
- Remove wire twist-ties from paper or plastic bags before placing bag in oven.
- Do not use the cavity for storage purposes . Do not leave paper products, cooking utensils or food in the cavity when not in use.
- If you use materials like paper, wood or plastic for cooking in your microwave, do not leave the oven unattended. Paper, wood and similar materials may ignite, while plastic materials may melt. Do not use containers made of materials for fan oven, grilling and mixed cooking operations.
- The contents of feeding bottles and baby food jars shall be stirred or shaken and the temperature checked before consumption, in order to avoid burns.

- Liquids and other foods must not be heated in sealed containers since they are liable to explode.
- Microwave heating of beverages can result in delayed eruptive boiling, therefore care must be taken when handling the container.
- Eggs in shell and hard-boiled eggs should not be heated in the microwave, as they may explode even after being heated in the microwave.
- Do not use your oven to heat carbonated drinks or foods stored in airtight containers like tin cans. This will cause pressure to build up inside the oven that may result in damage or explosion when the door is opened.
- Do not use your microwave oven for cooking or reheating unwhisked eggs, whether shelled or not. Ensure that you pierce the skins of potatoes, apples, chestnut or similar fruits and vegetables before cooking.
- Do not use porcelain containing metal (silver, gold, etc.). Ensure that you remove all metal twist-ties from food packages. Pieces of metal inside the oven can cause arcing that may result in serious damage.
- Do not use your oven with oil to fry food as you will not be able to adjust the temperature of the oil.
- Do not use the microwave to warm cooking oil or drinks with high alcohol volume only.
- Do not place the oven where heat, moisture, or high humidity are generated, or near flammable materials.
- Do not use the interior of your oven for storage purposes.
- Should the contents of the oven catch fire or should you notice any smoke, keep the oven door closed. Switch off the oven and remove the plug from the socket, or else remove or switch off the fuses for your home.
- Do not lean on the oven door when it is open, or let children tinker it. This will warp the oven door and prevent it from closing properly.
- Put a metal teaspoon or glass rod in the container when heating up liquids. This will prevent delay of boiling of the

liquid, thus prevent sudden overflowing when the container is moved.

- Do not use the oven, if:
  - The door is not closed properly;
  - The door hinges are damaged;
  - The contact surfaces between the door and the front side of the oven are damaged;
  - The door window is damaged;
  - An electrical arch occurs within the oven although there are no metal object in the cooking segment.
- It is very important not to select long durations or extremely high power levels while cooking a small amount of food in order to avoid overheating or burning the meal. For example, a slice of bread may burn after 3 minutes if a very high power level is selected.
- Do not use the oven for frying as it is not possible to control the temperature of oil heated in microwave.

- Contact surfaces of the door (front side of the inner segment and inner side of the doors), must be kept clean to ensure proper operation of the oven.



## **1.5 Transportation Safety**

- Disconnect the product from the mains before transporting the product.
- The product is heavy, carry the product with at least two people.
- Do not use the door and / or handle to transport or move the product.
- Do not put other items on the product and carry the product upright.
- When you need to transport the product, wrap it with bubble wrap packaging material or thick cardboard and tape it tightly. Secure the product tightly with tape to prevent the removable or moving parts of the product and the product from getting damaged.
- Check the overall appearance of the product for any damage that may have occurred during transportation.

## 1.6 Installation Safety

- Before the product is installed, check the product for any damage. If the product is damaged, do not install it.
- Do not install the product near heat sources (radiators, stoves, etc.).
- Keep the surroundings of all ventilation ducts of the product open.
- To prevent overheating, the product should not be installed behind decorative doors.

## 1.7 Safety of Use

- Ensure that the product is switched off after every use.
- If you will not use the product for a long time, unplug it or turn off the fuse from the fuse box.
- Do not operate defective or damaged product. If any, disconnect the electricity / gas connections of the product and call the authorized service.
- Do not use the product if the front door glass is removed or cracked.

- Do not climb on the product to reach anything or for any other reason.
- Never use the product when your judgement or coordination is impaired by the use of alcohol and/or drugs.
- Flammable objects kept in the cooking area may catch fire. Never store flammable objects in the cooking area.
- The oven handle is not a towel dryer. When using the product, do not hang towels, gloves or similar textiles on the handle.
- The hinges of the product door move when opening and closing the door and might jam. When opening / closing the door, do not hold the part with the hinges.

## 1.8 Temperature Warnings

- **WARNING:** The accessible parts of the product will be hot during use. Care should be taken to avoid touching the product and heating elements. Children under the age of 8 should not be brought close to the product without an adult.

- Do not place flammable / explosive materials near the product, as the edges will be hot while it is operating.
- As steam may be exhaled, keep away while opening the oven door. The steam may burn your hand, face and / or eyes.
- During operation, the product may become hot. Care should be taken to avoid touching hot parts, inside of the oven and heating elements.
- Always use heat resistant oven gloves while placing food in the hot oven, or removing the food from the hot oven, etc.

### **1.9 Accessory Use**

- It is important that the wire grill and tray are placed properly on the wire shelves. For detailed information, refer to the section "**Usage of accessories**".
- Accessories can damage the door glass when closing the product door. Always push the accessories to the end of the cooking area.

### **1.10 Cooking Safety**

- Be careful when using alcoholic drinks in your dishes. Alcohol evaporates at high temperatures and may cause fire since it can ignite when it comes into contact with hot surfaces.
- Food waste, oil, etc. in the cooking area may catch fire. Before cooking, remove such coarse dirt.
- Food Poisoning Hazard: Do not let food sit in oven for more than 1 hour before or after cooking. Otherwise it may cause food poisoning or diseases.
- Do not heat closed tins and glass jars in the oven. The pressure that would build-up in the tin/jar may cause it to burst.
- Place the greaseproof paper in a cookware or on the oven accessory (tray, wire grill, etc.) with food and place it in the preheated oven. Remove any excessive pieces of greaseproof paper hanging from the accessory or container to avoid the risk of touching the oven heater elements. Never use greaseproof paper at an oven temperature

higher than the maximum use temperature specified on the greaseproof paper you are using. Never place greaseproof paper on the oven base.

- Do not place baking trays, dishes or aluminium foil directly onto the bottom of the oven. The accumulated heat might damage the bottom of the oven.
- Close the oven door during grilling. Hot surfaces may cause burns!
- Food not suitable for grilling carries a fire hazard. Grill only food that is suitable for heavy grill fire. Also, do not place the food too far in the back of the grill. This is the hottest area and fatty foods may catch fire.



## 1.11 Maintenance and Cleaning Safety

- Wait for the product to cool before cleaning the product. Hot surfaces may cause burns!
- Never wash the product by spraying or pouring water on it! There is the risk of electric shock!
- Do not use steam cleaners to clean the product as this may cause an electric shock.
- Do not use harsh abrasive cleaners, metal scrapers, wire wool or bleach materials to clean the oven front door glass / (if present) oven upper door glass. These materials can cause glass surfaces to be scratched and broken.
- Always keep the control panel clean and dry. A damp and dirty surface may cause problems in operating the functions.

## 2 Environmental Instructions

### 2.1 Waste Directive

#### 2.1.1 Compliance with the WEEE Directive and Disposing of the Waste Product

This product complies with EU WEEE Directive (2012/19/EU). This product bears a classification symbol for waste electrical and electronic equipment (WEEE).



This product has been manufactured with high quality parts and materials which can be re-used and are suitable for recycling. Therefore, do not dispose of the waste product with normal domestic and other wastes at the end of its service life. Take it to a collection point for the recycling of electrical

and electronic equipment. You can ask your local administration about these collection points. Disposing of the appliance properly helps prevent negative consequences for the environment and human health.

---

### **Compliance with RoHS Directive:**

The product you have purchased complies with EU RoHS Directive (2011/65/EU). It does not contain harmful and prohibited materials specified in the Directive.

## **2.2 Package Information**

Packaging materials of the product are manufactured from recyclable materials in accordance with our National Environment Regulations. Do not dispose of the packaging waste with the household or other wastes, take it to the packaging material collection points designated by the local authorities.

## **2.3 Recommendations for Energy Saving**

According to EU 66/2014, information on energy efficiency can be found on the product receipt supplied with the product.

The following suggestions will help you use your product in an ecological and energy-efficient way:

- Defrost frozen food before cooking.
- In the oven, use dark or enamelled containers that transmit heat better.
- If specified in the recipe or user's manual, always preheat. Do not open the oven door frequently during cooking.
- Turn off the product 5 to 10 minutes before the end time of cooking in prolonged cookings. You can save up to 20% electricity by using residual heat.
- Try to cook more than one dish at a time in the oven. You may cook at the same time by placing two cookers on the wire rack. In addition, if you cook your meals one after the other, it will save energy because the oven will not lose its heat.
- Do not open the oven door when cooking in the "Eco fan heating" operating function. If the door is not opened, the internal temperature is optimized to save energy in the "Eco fan heating" operating function, and this temperature may differ from what is shown on the display.

## 3 Your product

### 3.1 Product Introduction

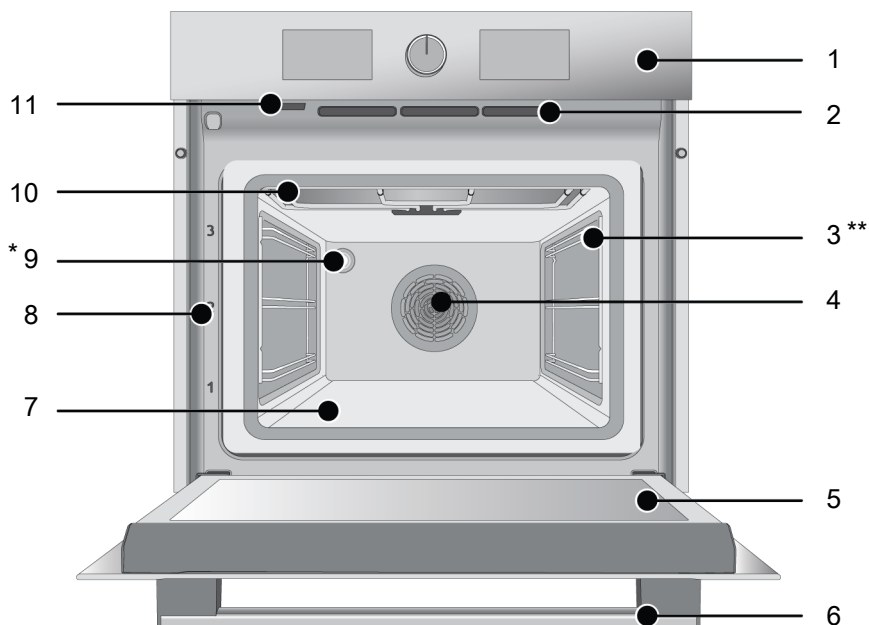

1 Control panel

3 Wire shelves

5 Door

7 Lower heater (under the steel plate)

9 Lamp

11 Steam exit hole: Steam is discharged from here during the operation of microwave. Condensation may form on the surrounding surfaces.

2 Ventilation holes

4 Fan motor (behind the steel plate)

6 Handle

8 Shelf positions

10 Upper heater

\* Varies depending on the model. Your product may not be equipped with a lamp, or the type and location of the lamp may differ from the illustration.

\*\* Varies depending on the model. Your product may not be equipped with a wire rack. In the image, a product with wire rack is shown as an example.

### 3.2 Product Control Panel Introduction and Usage

In this section, you can find the overview and basic uses of the product's control panel. There may be differences in images and some features depending on the type of product.



### 3.2.1 Control Panel

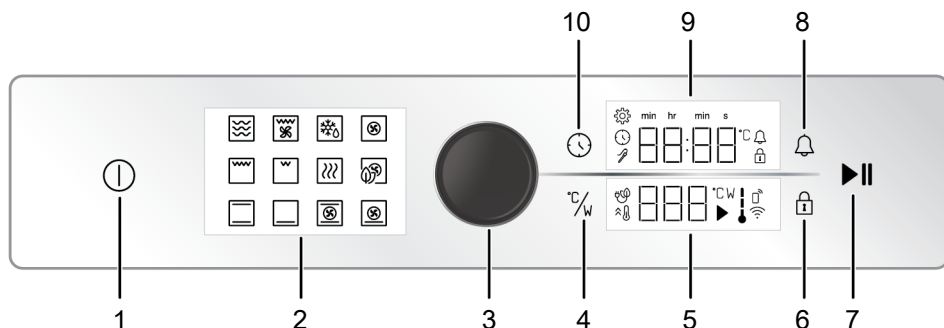

- 1 On/off key
- 2 Function display
- 3 Oven control knob
- 4 Temperature/Power key
- 5 Temperature indicator area
- 6 Key lock key
- 7 Cooking start/stop key
- 8 Alarm key
- 9 Timer/duration indicator area
- 10 Time and settings key

If there are knob(s) controlling your product, in some models this/these knob(s) may be so that they come out when pushed (buried knobs). For settings to be made with these knobs, first push the relevant knob in and pull out the knob. After making your adjustment, push it in again and replace the knob.

### 3.2.2 Introduction of the oven control panel

#### Oven control knob

You may check the settings on the timer/clock indicator and temperature indicator areas with the oven control knob. You may transit through these settings by turning this oven control knob to right and left and apply them by pushing the knob.

#### Oven inner temperature indicator

You can understand the oven inner temperature from the inner temperature symbol on the display. When the cooking starts, the symbol is seen on the display and when the oven inner temperature reaches the set temperature, each level of the symbol illuminates.

#### Function display

Working functions of your oven are located at the function display on your oven. Each function is activated by touching it. All functions located on the display are schematic, they may not be present in your appliance. Functions of your product are described in the section titled "Oven operating functions".

#### Indicator areas:

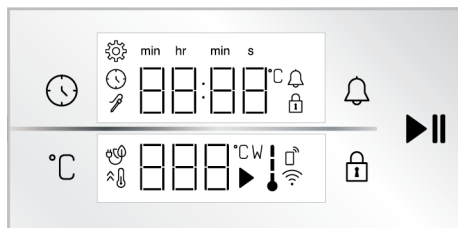

#### Keys :

- : Time and settings key
- : Temperature/Power key
- : Key lock key
- : Alarm key
- : Cooking start/stop key

#### Timer/duration indicator area :

- : Cooking time/time of day symbol
- : Alarm symbol

 : Settings symbol

 : Key lock symbol

**s** : Seconds symbol

**min** : Minutes symbol

**hr** : Timer symbol

 : Meat probe symbol \*

\* It varies depending on the product model. It may not be available on your product.

#### Temperature indicator area :

 : Cooking symbol

 : Temperature symbol

 : Microwave power symbol

 : In-oven temperature symbol

 : Symbol of cooking with eco fan

 : Quick heating (booster) symbol

 : Remove control symbol \*

 : Wifi symbol \*

\* : It varies depending on the product model. It may not be available on your product.





### 3.3 Oven operating functions





On the function table, the operating functions you can use in your oven and the highest and lowest temperatures that can be set for these functions are shown. The order of the operating modes shown here may differ from the arrangement on your product.

Operating functions of your oven work in 3 different principles which are only microwave function, only oven function, and combined mode.



Operation Mode	Specifications
Microwave	By operating in only microwave mode, the oven directly heats the inside of the meal. You may use the microwave for heating pre-cooked meals and drinks, defrosting and cooking. A meal would cook at the microwave mode but it would not be roasted.
Oven function	By operating only the oven heaters, it cooks the meal by heating. You may use the oven for all your cookings and defrostings. In the oven function, the meal both cooks and roasts.
Combined mode	In the combined mode, both the oven heaters and the microwave operates at the same time. The meal cooks and roasts faster in the combined mode.

#### Oven functions

Function symbol	Function description	Temperature range (°C)	Description and use
	Top and bottom heating	40-280	Food is heated from above and below at the same time. Suitable for cakes, pastries or cakes and stews in baking moulds. Cooking is done with a single tray.
	Bottom heating	40-220	Only lower heating is on. It is suitable for foods that need browning on the bottom.
	Fan Heating	40-280	The hot air heated by the fan heater is distributed equally and rapidly throughout the oven with the fan. It is suitable for multi-tray cooking at different shelf levels.
	Eco fan heating	160-220	In order to save energy, you can use this function instead of using "Fan Heating" in the range of 160-220°C. But; cooking time will be slightly longer. The use of this function is explained at the section titled "Operation of oven control unit".
	Pizza function	40-280	The lower heater and fan heating work. It is suitable for cooking pizza.

	"3D" function	40-280	Upper heating, lower heating and fan heating functions operate. Each side of the product to be cooked is cooked equally and quickly. Cooking is done with a single tray.
	Low grill	40-280	The small grill on the oven ceiling works. It is suitable for grilling smaller amounts.
	Full grill	40-280	The large grill on the oven ceiling works. It is suitable for grilling in large amounts.
	Fan assisted full grill	40-280	The hot air heated by the large grill is quickly distributed into the oven with the fan. It is suitable for grilling in large amounts.
	Keep warm	40-100	It is used to keep the food at a temperature ready for service for a long time.

### Microwave and combined modes

Function symbol	Function description	Temperature range (°C)	Power range (W)	Description and use
	Microwave	-	100 200 300 600 800	Only works at microwave. It may be used to heat premade meals and drinks, and cooking meals. Meals cook without roasting.
	Microwave + Fan assisted large grill	40-280	100 200 300 600	The hot air heated by the large grill and the microwave is quickly distributed into the oven with the fan. It is suitable for grilling in large amounts.
	Microwave + Defrost	-	100 200 300 600	The microwave and only the fan (on the back wall) operates. It is suitable for melting frozen grained foods in room temperature and cooling the cooked meals.

	Microwave + Turbo	40-280	100 200 300 600	The back heater of the oven operates with the microwave. The hot air heated by the rear heater is distributed equally and rapidly throughout the oven with the fan. You may cook the meal quickly while also roasting it.
	Microwave + Lower and upper heating	40-280	100 200 300 600	Food is heated with the microwave from above and below at the same time. Suitable for cakes, pastries or cakes and stews in baking moulds. Cooking is done with a single tray.
	Microwave + Pizza	40-280	100 200 300 600	The lower heater and fan heating work together with the microwave. It is suitable for cooking pizza.

### 3.4 Product Accessories

There are various accessories in your product. In this section, the description of the accessories and the descriptions of the correct usage are available. Depending on the product model, the supplied accessory varies. All accessories described in the user's manual may not be available in your product.



The trays inside your appliance may be deformed with the effect of the heat. This has no effect on the functionality. Deformation disappears when the tray is cooled.

#### Standard tray

It is used for pastries, frozen foods and frying large pieces.



#### Wire grill

It is used for frying or placing the food to be baked, fried and stewed on the desired shelf.

##### On models with wire shelves :

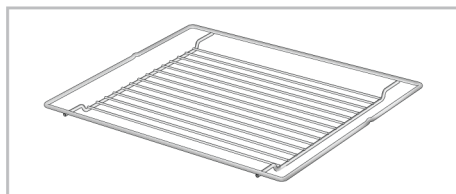

##### On models without wire shelves :

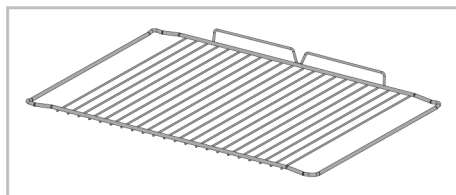

#### Wire grill in tray

By placing it in the tray (if provided), it is ensured that the oils flowing while grilling are collected in the tray and thus the contamination of the oven is prevented.

Wire grill in tray is not suitable for use in deep tray.

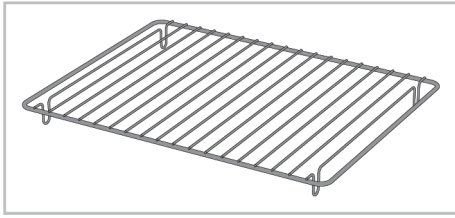

### 3.5 Use of Product Accessories

#### Cooking shelves

There are 3 levels of shelf position in the cooking area. You can also see the order of the shelves in the numbers on the front frame of the oven.

##### On models with wire shelves :

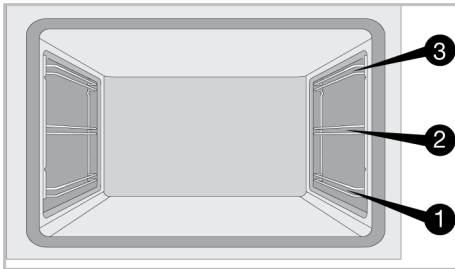

##### On models without wire shelves :

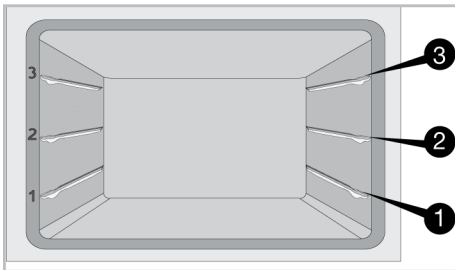

**i** "0 shelf spot" is the oven floor. Do not use it other than for microwave.

#### Placing the wire grill on the cooking shelves

It is crucial to place the wire grill on the wire side shelves properly. While placing the wire grill on the desired shelf, the open section must be on the front. For better cooking, the

wire grill must be secured on the wire shelf's stopping point. It must not pass over the stopping point to contact with the rear wall of the oven.

##### On models with wire shelves :

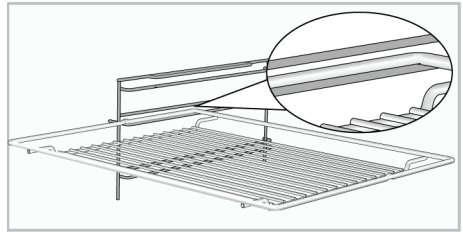

##### On models without wire shelves :

It is crucial to place the wire grill on the side shelves properly. The wire grill has one direction when placing it on the shelf. While placing the wire grill on the desired shelf, the open section must be on the front.

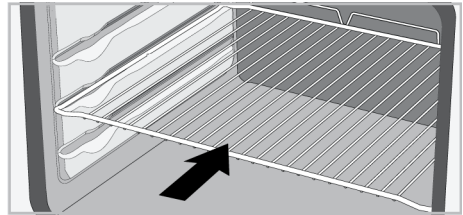

#### Placing the tray on the cooking shelves

It is also crucial to place the trays on the wire side shelves properly. While placing the tray on the desired shelf, its side designed for holding must be on the front. For better cooking, the tray must be secured on the stopping socket on the wire shelf. It must not pass over the stopping socket to contact with the rear wall of the oven.

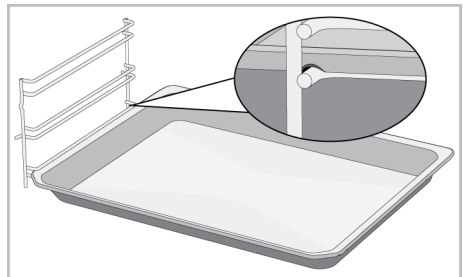

### Stopping function of the wire grill

There is a stopping function to prevent the wire grill from tipping out of the wire shelf. With this function, you can easily and safely take out your food. While removing the wire grill, you can pull it forward until it reaches the stopping point. You must pass over this point to remove it completely.

#### On models with wire shelves :

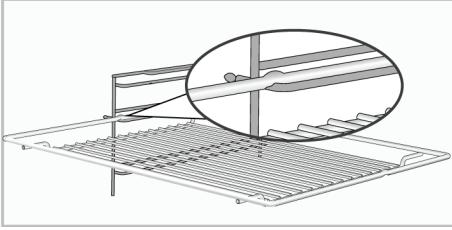

#### On models without wire shelves :

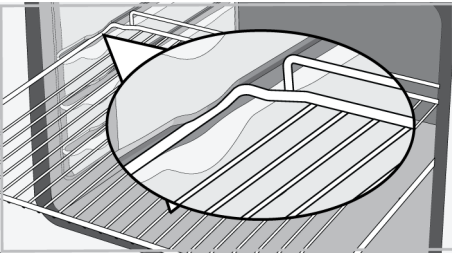

### Tray stopping function

There is also a stopping function to prevent the tray from tipping out of the wire shelf. While removing the tray, release it from the rear stopping socket and pull it towards yourself until it reaches the front side. You must pass over this stopping socket to remove it completely.

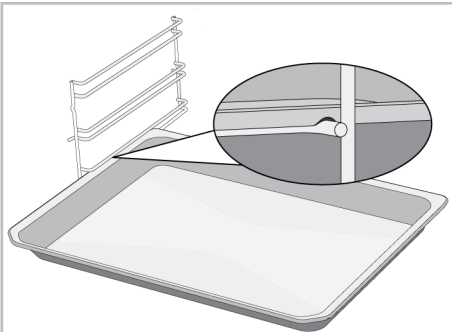

### Proper placement of the wire grill and tray on the telescopic rails-On models with wire shelves and telescopic models

Thanks to telescopic rails, trays or the wire grill can be easily installed and removed. When using trays and wire grills with the telescopic rail, care should be taken that the pins on the front and back of the telescopic rails, rest against the edges of the grill and the tray (shown in the figure).

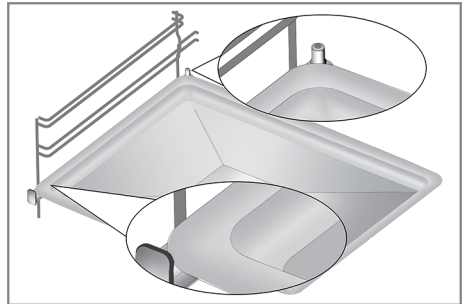
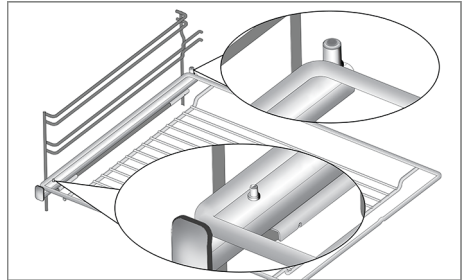

## 3.6 Technical Specifications

<b>General specifications</b>	
Product external dimensions (height/width/depth) (mm)	455 /594 /567
Oven installation dimensions (height / width / depth) (mm)	450 - 460 /560 /min. 550
Voltage/Frequency	220-240 V ~; 50 Hz
Cable type and section used/suitable for use in the product	min. H05VV-FG 3 x 1,5 mm <sup>2</sup>
Total power consumption (kW)	2,7
Fuse (min.)	
Oven type	Multifunction oven

<b>Microwave features</b>	
Net volume	48 lt
Microwave power	max. 800 W
Microwave frequency	2465 MHz

Basics: Information on the energy label of home type electrical ovens is given in accordance with the EN 60350-1 / IEC 60350-1 standard. The values are determined in Top and bottom heating or (if present) Fan assisted bottom/top heating functions with the standard load.

Energy efficiency class is determined in accordance with the following prioritization depending on whether the relevant functions exist on the product or not. 1-Eco fan heating , 2-Fan Heating , 3-Fan assisted low grill , 4-Top and bottom heating.



Technical specifications may be changed without prior notice to improve the quality of the product.



Figures in this manual are schematic and may not exactly match your product.



Values stated on the product labels or in the documentation accompanying it are obtained in laboratory conditions in accordance with relevant standards. Depending on operational and environmental conditions of the product, these values may vary.

See also

2 [ ] 000]

## 4 First Use

Before you start using your product, it is recommended to do the following stated in the following sections respectively.

### 4.1 First Timer Setting

**i** Always set the time of day before using your oven. If you do not set it, you cannot cook in some oven models.

- a. With the oven turned off (while the time of day appears on the display), touch the ⌚ key for about 3 seconds to activate the settings menu.

⇒ A countdown of 3-2-1 appears on the display. When the countdown is over, the settings menu is activated.

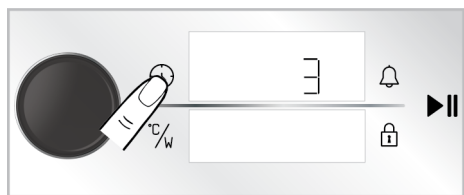

- b. Activate the timer field by pushing the oven control knob once or touching the ⌚ key once.

⇒ The timer field and the ⚙️ symbol flash on the timer/duration display.

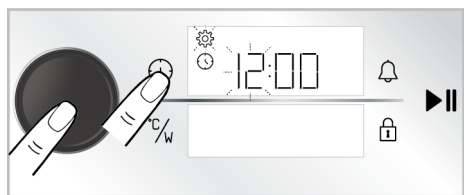

- c. Set the time of day by turning the oven control knob to right/left and activate the minute field by pushing the oven control knob once or touching the ⌚ key once.

⇒ The minutes field and the ⚙️ symbol flash on the timer/duration display.

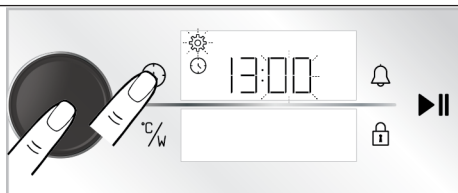

- d. Set the minute by turning the oven control knob to right/left. Approve the setting by pushing the oven control knob once or touching the ⌚ key once.

⇒ The time of day is set and the ⚙️ symbol illuminates continuously.

**i** If the first timer setting is not performed, the time of day starts from the time set at the production process. You can change the time of day setting later as described in the “Settings” section.

**i** In the event of a long power outage, the time of day setting is cancelled. It should be set again.

### 4.2 Initial Cleaning

- a. Remove all packaging materials.
- b. Remove all accessories from the oven provided with the product.
- c. Operate the product for 30 minutes and then, turn it off. This way, residues and layers that may have remained in the oven during production are burned and cleaned.
- d. When operating the product, select the highest temperature and the operating function that all the heaters in your product operate. See “Oven operating functions [▶ 18]”. You can learn how to operate the oven in the following section.
- e. Wait for the oven to cool.
- f. Wipe the surfaces of the product with a wet cloth or sponge and dry with a cloth.



### **Before using the accessories:**

Clean the accessories you remove from the oven with detergent water and a soft cleaning sponge.

**NOTICE:** Some detergents or cleaning agents may cause damage to the surface. Do not use abrasive detergents, cleaning powders, cleaning creams or sharp objects during cleaning.

## **5 Using the Oven**

---

### **5.1 General Information on Using the Oven**

#### **Cooling fan ( It varies depending on the product model. It may not be available on your product. )**

Your product has a cooling fan. The cooling fan is activated automatically when necessary and cools both the front of the product and the furniture. It is automatically deactivated when the cooling process is finished. Hot air comes out over the oven door. Do not cover these ventilation openings with anything. Otherwise, the oven may overheat. The cooling fan continues to operate during oven operation or after the oven is turned off

### **5.2 Operation of the Oven Control Unit**

#### **General warnings for the oven control unit**

- The maximum time that can be set for the cooking process is 5:59 hours. In keeping warm function, this time is 23:59 hours. In case of a power outage, the pre-set cooking and cooking duration are cancelled.
- While making any adjustments, the relevant symbols flash on the display. It is necessary to save the settings made, either by touching the relevant key in the description or by waiting for a short time.

**NOTICE:** During the first use, smoke and odour may come up for several hours. This is normal and you just need good ventilation to remove it. Avoid directly inhaling the smoke and odours that form.

(approximately 20-30 minutes). If you cook by programming the oven timer, at the end of the cooking time, the cooling fan turns off with all functions. The cooling fan running time cannot be determined by the user. It turns on and off automatically. This is not an error.

#### **Oven lighting**

The oven lighting is turned on when the oven starts cooking. In some models, the lighting is on during cooking, while in some models it turns off after a certain time.

If the product door is opened while the oven is operating or in the closed position, the oven lighting turns on automatically.

- If cooking time is set when cooking starts, the remaining time is shown on the display.
- If the quick preheat setting is active on the control unit the  symbol appears on the display when you start cooking and the oven reaches the temperature you set for cooking quickly. For quick preheat setting, see the “**Settings**” section.

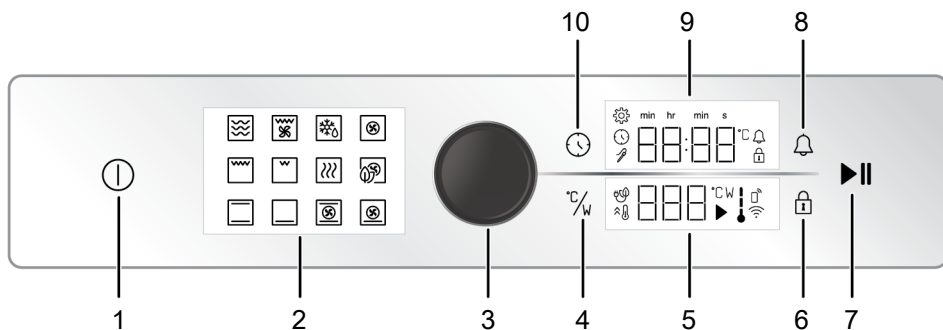

- 1 On/off key
- 2 Function display
- 3 Oven control knob
- 4 Temperature/Power key
- 5 Temperature indicator area
- 6 Key lock key
- 7 Cooking start/stop key
- 8 Alarm key
- 9 Timer/duration indicator area
- 10 Time and settings key

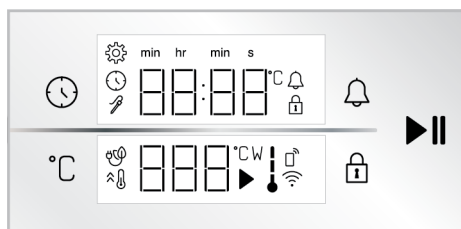

#### Temperature indicator area :

- : Cooking symbol
- $^{\circ}\text{C}$  : Temperature symbol
- $\text{W}$  : Microwave power symbol
- $\downarrow$  : In-oven temperature symbol
- : Symbol of cooking with eco fan
- : Quick heating (booster) symbol
- : Remove control symbol \*
- : Wifi symbol \*

\* : It varies depending on the product model. It may not be available on your product.

#### Keys :

- : Time and settings key
- $^{\circ}\text{C}/\text{W}$  : Temperature/Power key
- : Key lock key
- : Alarm key
- : Cooking start/stop key

#### Timer/duration indicator area :

- : Cooking time/time of day symbol
- : Alarm symbol
- : Settings symbol
- : Key lock symbol
- s** : Seconds symbol
- min** : Minutes symbol
- hr** : Timer symbol
- : Meat probe symbol \*

\* It varies depending on the product model. It may not be available on your product.

### Turning on the oven

a. Turn the oven on by touching the key.

⇒ After the oven is turned on, the first operating function is shown on the display. The operating function, temperature, cooking time and alarm can be adjusted when the display is in this status.

If no setting is made on this display, the oven turns off in approximately 5 minutes and the time of day is shown on the display.

### Turning off the oven

Turn off the oven by touching the key. The time of day is shown on the display.

## Manual cooking by selecting temperature and oven operating function

You can cook by making a manual control (at your own control) without setting the cooking time by selecting the temperature and operating function specific to your food. As an example, the “Top and bottom heating” function and 180 °C settings are shown in the pictures.

- Turn the oven on by touching the  key.
- Touch the operation function you want to activate on the function display.



- The pre-set temperature for the operating function you selected appears on the display. To change this temperature, push the oven control knob once or touch the °C key and turn the oven control knob to the right/left.

⇒ The °C symbol flashes on the temperature display.

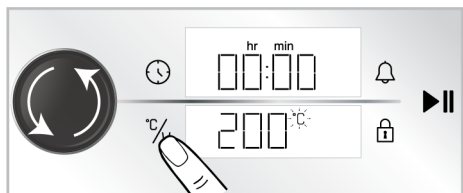

 If you change the operating function after you change the pre-set temperature of the operating function, the last temperature set is shown on the display. However, if the selected temperature is not between the temperature range of the selected operating function, the highest temperature for that operating function is displayed.

- Confirm the set temperature by touching the °C key.

⇒ The °C symbol lights up continuously on the temperature display.

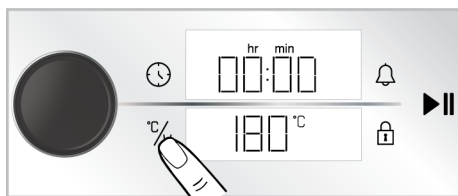

- After setting up operating function and the temperature touch the ▶|| key to start cooking.



⇒ Your oven will start operating immediately at the selected function and temperature. On the temperature display, the ↓ and ▶ symbols are shown. Cooking time starts counting up on the display. As the temperature inside the oven reaches the set temperature, each stage of the oven temperature ↓ symbol will light up. The oven does not switch off automatically since manual cooking is done without setting the cooking time. You have to control cooking and turn it off yourself. When the cooking is completed touch the ▶|| key to end the cooking or touch the ⓘ key to turn off the oven completely.

## Cooking by setting the cooking time;

You can have the oven turn off automatically at the end of the time by selecting the temperature and operating function specific to your food and setting the cooking time on the timer. As an example, the “Top and bottom heating” function, 180 °C and 45 minutes cooking time settings are shown in the pictures.

- Turn the oven on by touching the ⓘ key.
- Touch the operation function you want to activate on the function display.

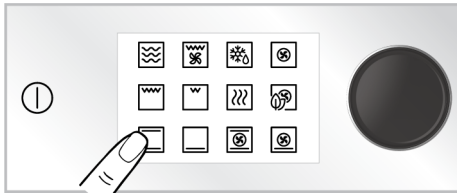

c. The pre-set temperature for the operating function you selected appears on the display. To change this temperature, push the oven control knob once or touch the °C key and turn the oven control knob to the right/left.

⇒ The °C symbol flashes on the temperature display.

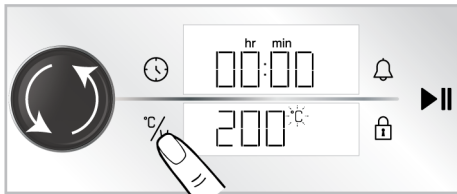

**i** If you change the operating function after you change the pre-set temperature of the operating function, the last temperature set is shown on the display. However, if the selected temperature is not between the temperature range of the selected operating function, the highest temperature for that operating function is displayed.

d. Confirm the set temperature by touching the °C key.

⇒ The °C symbol lights up continuously on the temperature display.

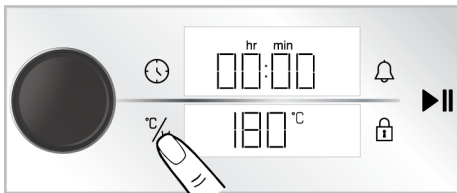

e. Push the oven control knob once or touch the ⌚ key once for the cooking time.

⇒ The set 30 minutes value appears on the timer/duration display and the ⌚ symbol flashes.

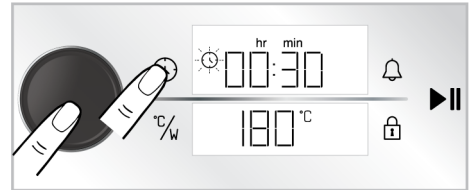

**i** To adjust the cooking time quickly, you can activate the cooking time as 30 minutes by pushing the oven control knob or touching the ⌚ key after the operation function and temperature are set, and you can change the time by turning the oven control knob to the right/left.

f. Adjust the cooking time by turning the oven control knob to the right/left. Confirm the setting by touching the ⌚ key.

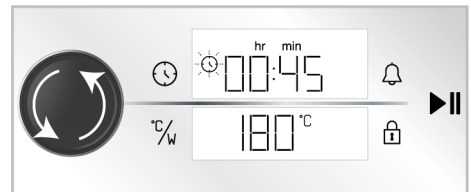

**i** The cooking time increases by 1 minute in the first 15 minutes and by 5 minutes after 15 minutes.

g. After setting up operating function, the temperature and the cooking time, touch the ▶▶ key to start cooking.



⇒ Your oven starts operating immediately at the selected function and temperature and the cooking time countdown appears on the display. On the temperature display, the **↓** and **▶** symbols are shown. As the temperature inside the oven reaches the set temperature, each stage of the oven temperature **↓** symbol will light up. When the cooking time is completed, “End” text appears on the temperature display, the timer gives an audible warning and cooking stops.

h. The warning sounds for one minute. If you touch the **▶||** key while the audible warning is given and the “End” text is displayed on the temperature display, the oven continues operating indefinitely. Turn off the oven by touching the **⏸** key. If any key is touched except for these, the audible warning stops.

### Using the microwave mode

- Turn the oven on by touching the **⏸** key.
- Touch the “Microwave” operation function on the function display.

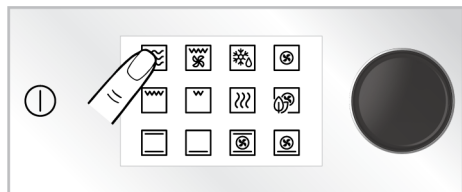

c. Touch the **⌂** key to change the microwave power level. Adjust the desired microwave power by turning the oven control knob to the right/left.

⇒ The **W** symbol flashes on the display.

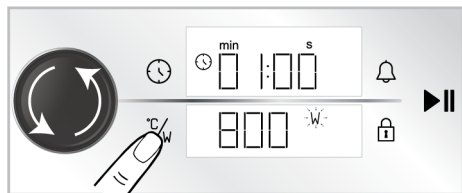

d. Confirm the set power by touching the **⌂** key.

⇒ The **W** symbol appears permanently on the display.

e. Push the oven control knob once or touch the **⏸** key once for the cooking time.

⇒ On the display, the **⏸** symbol and the second field flash.

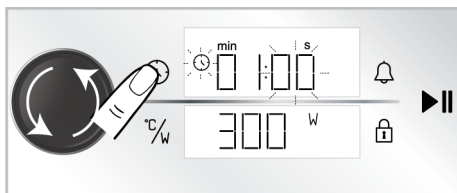

f. Adjust the cooking time in seconds by turning the oven control knob to the right/left.

g. Confirm the cooking time's second by touching the **⏸** key.

⇒ On the display, the **⏸** symbol and the minute field flash.

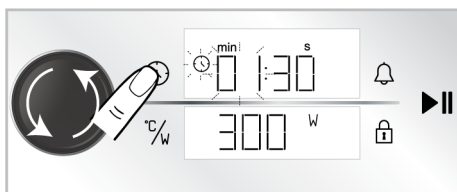

h. Adjust the cooking time in minutes by turning the oven control knob to the right/left.

i. Confirm the cooking time in minutes by touching the **⏸** key.

**i** The maximum microwave power is limited to 600W when the selected cooking time in microwave mode exceeds 12 minutes. The microwave power is automatically set to 600W when the selected cooking times exceed 12 minutes.



The cooking time intervals are determined automatically based on the microwave power you set and cannot be changed. The 800 W/ 1 minute and 30 second settings are shown as examples in the pictures.

- j. To start the cooking touch the ►|| key.

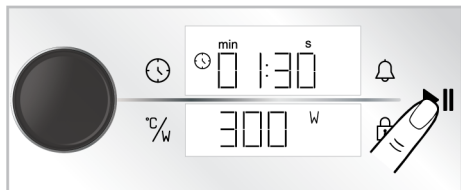

⇒ Your oven will start operating immediately in microwave function and power. The set cooking time starts to count down. On the display, the ► and W symbols are shown. When the cooking time is completed, “End” text appears on the display, audible warning is given and cooking stops.

- k. The warning sounds for one minute. If you touch the ►|| key while the audible warning is given and the “End” text is shown on the display, the oven continues operating for one more minute. Turn off the oven by touching the ① key. If any key is touched except for these, the audible warning stops.

### Using the Combi mode (Oven and microwave together)

- a. Turn the oven on by touching the ① key.  
b. Touch the “Microwave” operation function on the function display.

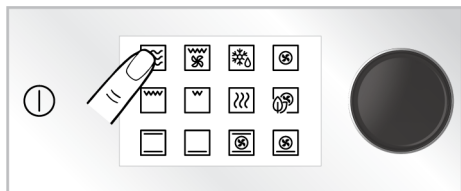

- c. Touch on the combi function you want to cook with the microwave function. Both will activate. (e.g. Microwave + Lower and upper heating)



- d. The pre-set temperature for the operating function you selected appears on the display. Turn the oven control knob right/left to change this temperature.

⇒ The °C symbol flashes on the display.

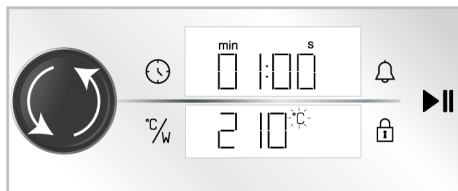

- e. Confirm the temperature by touching the °C/W key.

⇒ The microwave power level is activated and the pre-defined microwave power appears on the display. The W symbol flashes on the display.

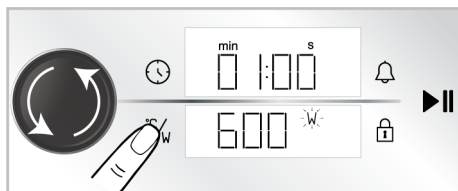

- f. To change the microwave power level, turn the oven control knob to the right / left and confirm the power setting by touching the °C/W key.  
g. Push the oven control knob once or touch the ① key once for the cooking time.

- ⇒ On the display, the ⌚ symbol and the second field flash.

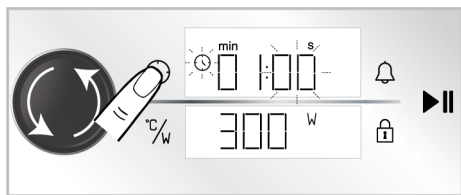

- h. Adjust the cooking time in seconds by turning the oven control knob to the right/left.
- i. Confirm the cooking time's second by touching the ⌚ key.
- ⇒ On the display, the ⌚ symbol and the minute field flash.

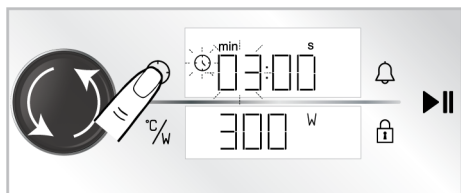

- j. Adjust the cooking time in minutes by turning the oven control knob to the right/left.
- k. Confirm the cooking time in minutes by touching the ⌚ key.

**i** When cooking in combi modes, the maximum microwave power is limited to 600W and is not dependent on the selected cooking time.

**i** The cooking time intervals are determined automatically based on the microwave power you set and cannot be changed. The 300 W/ 3 minute setting is shown as examples in the pictures.

- l. To start the cooking touch the ▶|| key.



- ⇒ Your oven will start operating immediately at the selected combi function, temperature and microwave power. The set cooking time starts to count down. On the display, the ▶ and ↓ symbols are shown. When the cooking time is completed, "End" text appears on the display, audible warning is given and cooking stops.

- m. The warning sounds for one minute. If you touch the ▶|| key while the audible warning is given and the "End" text is shown on the display, the oven continues operating for one more minute. Turn off the oven by touching the ⌚ key. If any key is touched except for these, the audible warning stops.

### 5.3 Settings



**i** The 3-2-1 countdown is shown on the display in the menus or settings that should be activated by pressing for a long period. When the count down expires, the relevant menu or setting is activated.

#### Activating the key lock

By using the key lock feature, you can safeguard the interference of the control unit.

- a. Touch the 🔒 key until the 🔒 symbol appears on the timer/duration display.





⇒ A countdown of 3-2-1 appears on the display. When the countdown is over, the  symbol appears on the timer/duration display and the key lock is activated. After the key lock is set, if any key is touched or the oven control knob is pushed, the timer sounds an audible signal and the  symbol flashes.



While the key lock is activated, the keys of the control unit cannot be used. The key lock will not be cancelled in case of power failure.

### Deactivating the key lock

a. Touch the  key until the  symbol appears on the timer/duration display.

⇒ A countdown of 3-2-1 appears on the display. When the countdown is over, the  symbol disappears on the timer/duration display and the key lock is deactivated.

### Setting the alarm

You can also use the control unit of the product for any warning or reminder other than cooking. The alarm clock has no effect on the oven operating functions. It is used for warning purposes. For example, you can use the alarm clock when you want to turn the food in the oven at a certain time. As soon as the time you set has expired, the timer gives you an audible warning.





The maximum alarm time may be 23 hours 59 minutes.

a. Touch the  key once to set the alarm period.

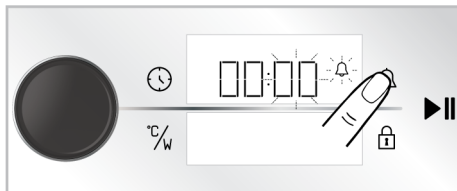
⇒ The minute field and  symbol start to flash on the timer/duration display.



b. First set the minutes by turning the oven control knob to the right/left and activate the timer field by touching the  key once.

c. Adjust the time by turning the oven control knob to the right/left. Touch the  key again to confirm the setting.

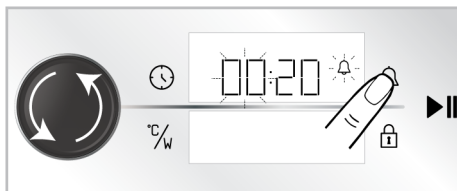

⇒ On the timer/duration display, the  symbol lights up continuously and the alarm time starts to count down on the display.

d. After the alarm time is completed, the  symbol starts flashing and gives you an audible warning.



If the alarm time and cooking time are set at the same time, the shorter time is shown on the timer/duration display.

### Turning off the alarm

a. At the end of the alarm period, the warning sounds for one minute. Touch any key to stop the audible warning.

⇒ The audible warning is stopped.

### If you want to cancel the alarm;

a. Touch the  key once to reset the alarm period.



⇒ The 🔔 symbol starts to flash on the timer/duration display.

- b. Turn the oven control knob to the right/left until the alarm time reaches “00:00”.

### Setting the volume

You may set the volume of your control unit. Your oven should be turned off to perform this setting.

- a. With the oven turned off (while the time of day appears on the display), touch the ⌚ key for about 3 seconds to activate the settings menu.

⇒ A countdown of 3-2-1 appears on the display. When the countdown is over, the settings menu is activated.

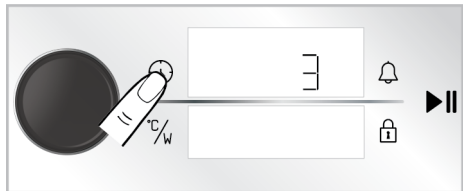

- b. Turn the oven control knob to the right/left until “b-1” or “b-2” appears on the timer/duration display.

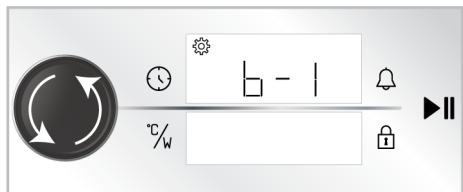

- c. Activate the tone setting by touching the ⌚ key again or pushing the oven control knob once.

⇒ The ⚙️ symbol flashes on the timer/duration display.

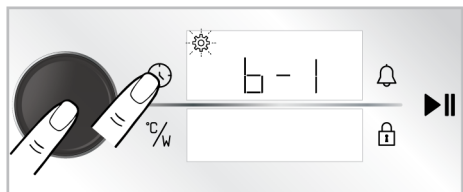

- d. Adjust the desired tone by turning the oven control knob to the right/left.

- e. Confirm the set tone by touching the ⌚ key again or pushing the oven control knob once.

### Setting the display brightness

You may set the brightness of the control unit display. Your oven should be turned off to perform this setting.

- a. With the oven turned off (while the time of day appears on the display), touch the ⌚ key for about 3 seconds to activate the settings menu.

⇒ A countdown of 3-2-1 appears on the display. When the countdown is over, the settings menu is activated.

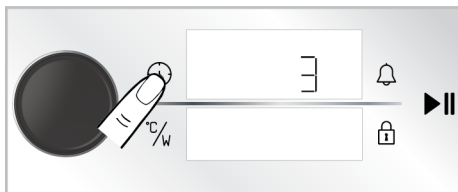

- b. Turn the oven control knob to the right/left until “d-1”, “d-2” or “d-3” appears on the timer/duration display.

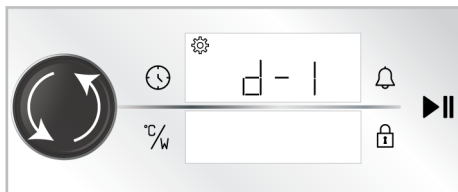

- c. Activate the brightness setting by touching the ⌚ key again or pushing the oven control knob once.

⇒ The ⚙️ symbol flashes on the timer/duration display.

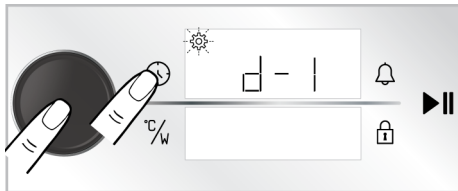

- d. Adjust the desired brightness by turning the oven control knob to the right/left.

- e. Confirm the brightness by touching the ⌚ key again or pushing the oven control knob once.

### Setting the quick preheating (Booster) function

You may operate the cooking on your product automatically with quick preheating function. For this purpose, you should activate the quick preheat setting. Your oven should be turned off to perform this setting.

- a. With the oven turned off (while the time of day appears on the display), touch the ⌚ key for about 3 seconds to activate the settings menu.

⇒ A countdown of 3-2-1 appears on the display. When the countdown is over, the settings menu is activated.

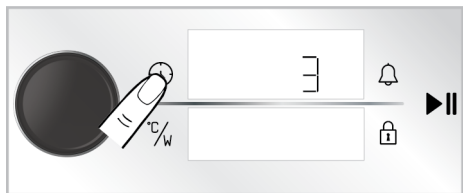

- b. Turn the oven control knob to the right/left until the 🔒 symbol and **"OFF"** appear on the display.



- c. Activate the quick preheat (Booster) setting by touching the ⌚ key or pushing the oven control knob once.

⇒ The ⚙️ symbol flashes on the timer/duration display.

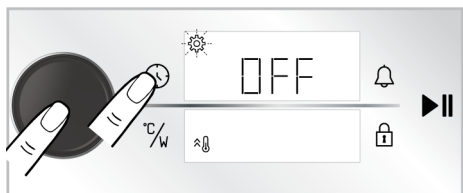

- d. Turn the **"OFF"** setting on the display to **"ON"** by turning the oven control knob to the right/left.

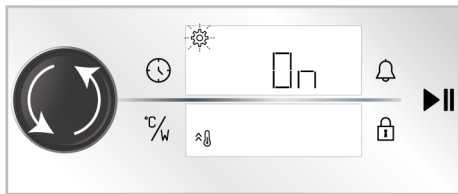

- e. Confirm the preheating (booster) setting by touching the ⌚ key again or pushing the oven control knob once.

**i** You may turn off the quick preheat setting with the same procedure. By turning the setting **"OFF"** you may cancel the quick preheat setting.

### Changing the time of day

To change the time of day that you have previously set,

- a. With the oven turned off (while the time of day appears on the display), touch the ⌚ key for about 3 seconds to activate the settings menu.

⇒ A countdown of 3-2-1 appears on the display. When the countdown is over, the settings menu is activated.

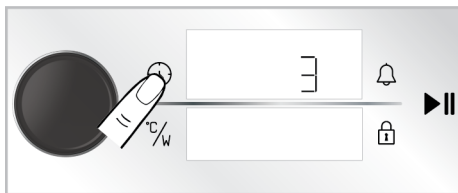

- b. Activate the timer field by pushing the oven control knob once or touching the ⌚ key once.

⇒ The timer field and the ⚙️ symbol flash on the timer/duration display.

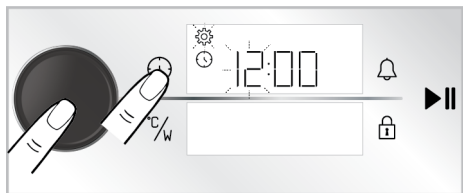

- c. Set the time of day by turning the oven control knob to right/left and activate the minute field by pushing the oven control knob once or touching the ⌚ key once.

⇒ The minutes field and the ⚙️ symbol flash on the timer/duration display.

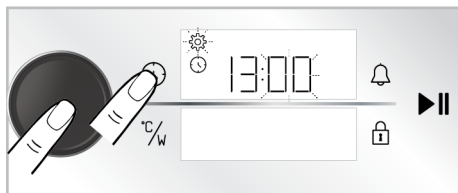

- d. Set the minute by turning the oven control knob to right/left. Approve the setting by pushing the oven control knob once or touching the ⌚ key once.

⇒ The time of day is set and the ⚙️ symbol illuminates continuously.

## 6 General Information About Cooking

You can find tips on preparing and cooking your food in this section.

Plus, this section describes some of the foods tested as producers and the most appropriate settings for these foods. Appropriate oven settings and accessories for these foods are also indicated.

### 6.1 General Warnings About Cooking in the Microwave Oven

To prevent overflow when heating water and other liquids in the microwave oven:

- Do not use closed or narrow lidded containers.
- Do not over heat.
- Before putting the container into the microwave, stir it with a spoon and open the lid, then in the middle of heating stir it again. Do not leave the spoon inside while the oven is operational.
- While heating liquids such as soup and sauce, these liquids may bubble and overflow unexpectedly before boiling. While heating such liquids, do not leave its side.
- While heating baby food or drink inside a baby bottle, before giving it to the baby, shake it and control its temperature. Remove the lid and the mouthpiece before heating.
- Remove the food from the plastic package before cooking or defrosting it. In certain exceptional cases, you may need to cover the food with a special nylon stretch film.

- Unless you use specially designed bags for microwave ovens, do not use your appliance for popcorn.
- Chocolate candies and baked goods with low liquid content should be heated carefully.
- Eggs in shell and hard-boiled eggs should not be heated in the microwave, as they may explode even after being heated in the microwave.

### Advantages of microwave

- In traditional ovens, the heat spread into the device through electrical elements and gas hobs penetrate the food from outside in. Because of that lots of energy was wasted to heat up the inside air, oven components and the food containers.
- In microwave oven, the heat is created through the food itself and the heat wave moves inside out. There is no heat loss at the inner walls of the oven or the containers (if they are the right material for microwave use), in other words only the food gets heated.
- Microwave ovens seriously decrease the cooking time. Microwave cooking requires about half to one-third of the time required in normal ovens. This depends on the density, heat and quantity of the content to be cooked.
- You may cook the food in its own juice without adding too much or no seasoning, and preserve its natural taste.

- Microwave ovens waste less energy. The energy is only used at cooking. Energy does not go to waste in a microwave.
- You do not need to worry about the meat being defrosted or not. Microwave ovens defrost frozen foods in little time, hence you may start cooking immediately. This reduces the risk of bacterial growth.
- Due to the shorter cooking time, it preserves the nutritional values of the food.
- It offers easier cleaning than conventional ovens.

### In theory the microwave

- Microwave is a sort of energy that is similar to radio and television waves. The magnetron tube inside your microwave oven creates microwave energy. Microwave energy spreads in all directions inside the oven and is reflected from the side walls, penetrating the food evenly. Microwaves cause the molecules in the food to vibrate rapidly. This vibration creates the heat that cooks the food.
- Microwaves do not pass through the metal walls of your oven. Microwaves can pass through materials such as ceramics, glass or paper.

### Why does food get hot?

- Most foods contain water, and water molecules vibrate when exposed to microwaves. The friction between the molecules creates the heat that warms the food, defrosts the frozen goods, cooks or keeps the warmth. Because of the rising heat inside the food
- Food can be cooked with little to no oil at all;
- Defrosting, heating or cooking is a lot faster in a microwave than it is in traditional ovens;
- The vitamins, minerals and nutrients are kept inside the food;
- The natural colour and flavour of the food does not change.

### Suitable containers for microwave ovens

Microwaves can pass through porcelain, glass, cardboard or plastic, but not metals. Therefore, metal containers or containers with metal parts cannot be used in a microwave oven.

Microwaves are reflected from metal...



...but go through glass or porcelain...

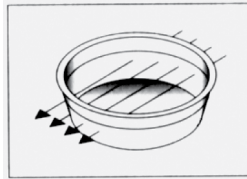

...and are absorbed by foods.

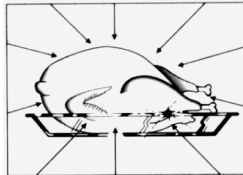

#### Fire risk

Never put your metal or metal coated containers into the microwave oven.

- Microwaves cannot penetrate metal. Microwaves will reflect off any metal objects in the oven causing dangerous electric arcing. Most heatproof non-metallic containers are suitable for use in a microwave oven. But some containers may include inappropriate material for use in a microwave oven. To determine if a container is suitable for a microwave, you may use the following test:

- Place the empty container you want to test and another container filled with water inside the oven.
- Run the oven at high power for one minute. If the water is warm and the container you are testing is cold, then the container is suitable for the microwave.
- On the other hand, if the water is cold and the container next to it gets hot, then microwaves have been absorbed by the container and this container is not suitable for microwave use.

### Glass containers

- Do not use thin glass or lead crystal containers. Heatproof containers are suitable for microwave ovens. But do not use fragile glass containers like water and wine glasses, materials of which can be broken when heated, in the microwave oven.

### Plastic containers

- Do not hold containers and dishes made of plastic or melamine in the microwave for too long; that goes for the plastic bags used to hold frozen food as well. The reason behind that is, the heat of a hot meal will eventually melt and deform the material. Use these types of material in the microwave for just a limited amount of time.

### Cooking bags

- Cooking bags can be used in the microwave oven as long as they are designed for cooking. Do not forget to pierce

the bags to allow the steam inside to escape. Do not use regular plastic bags for cooking as they will melt and open.

### Paper

- Do not use any type of paper for prolonged cooking. This will cause the paper to burst into flames. Paper plates are only good for oily or dry food that requires small amount of time to cook.
- Do not use recycled paper. These papers may have molecules that may cause arches.

### Wooden and wicker containers

- Large wooden containers should not be used, as the microwave causes the wood structure to dry out and become brittle.

### Porcelain containers

- Generally, containers made of these types of material are good to use inside microwave ovens, but you need to test it to be sure.

### Metal containers

- Metal containers reflect microwaves away from food. So do not use them.



Certain cookware with high iron and lead content is not suitable for use in microwave ovens. Be sure to check if your containers are microwave-safe.

Cooking vessel	Microwave	Low grill	Top and bottom heating	Combined modes
Heatproof Glass	Yes	Yes	Yes	Yes
Heat Transmitting Glass	No	No	No	No
Heatproof Ceramic	Yes	Yes	Yes	Yes
Plastic Plate that can be Used in a Microwave	Yes	No	No	No
Kitchen Paper	Yes	No	No	No
Metal Tray	Yes*	Yes	Yes	Yes*
Metal Grill	No	Yes	Yes	No
Aluminum Foil & Foil Container	No	Yes	Yes	No

\* Only use the metal tray given with the oven.

## Placement of the food

- You will have the optimum outcome if you spread the food equally on the container. This method can be applied in many ways with satisfactory results.
- You can cook large quantities of similar items (e.g. potatoes) together. They will cook better if you place them in evenly spaced circles in the oven. Be careful not to overlap the pieces.
- When cooking dishes of different shapes and thicknesses, place the thicker parts in the middle of the tray, as microwaves will have a stronger effect on the outer layers of these food. Therefore you will have them cook faster.
- Place fish and other uneven food with the tail on the edge of the tray.
- You can stack thinly cut pieces of meat on top of each other. Thicker items such as sausages and pieces of meat should be placed side by side.
- Warm the broth and sauces in a different plate. Narrow and deep plates are better for this job than wide and shallow plates. When heating broth, sauce or soup, the containers should not be more than two-thirds full.
- If you are cooking the whole fish, poke holes to it so that the skin does not burst.
- When using stretch film, bags or baking paper, poke holes or leave an opening to allow steam to escape.
- Small pieces of food will cook faster than large pieces, equal pieces will cook faster than uneven ones. For best results, cut your food into equal sized portions.

## Food height

- Very thick foods (usually roasts) will cook faster on the bottom. That means you may have to turn them several times.
- Thick or dense parts can be placed in a higher position so that the microwaves can also affect the lower and middle part of the piece.

## Cooking tips

### Factors effecting the microwave time:

- Microwave time depends on a few factors. The heat of the ingredients used in the recipe can significantly affect the cooking time required. Therefore, a cake made with ice-cold butter, milk, and eggs will take longer to bake than a cake made from room-temperature ingredients.
- Especially some recipes for bread, cake and cream sauces, recommend removing it from the oven before it is fully cooked. Such dishes kept closed outside the oven, will allow the food to continue to cook as the heat travels from the outside of it to the inside.
- If you keep the pieces in the oven until they are fully cooked, there is a risk of burning the outer layer. You will get the hang of which meals to be left to cook and which to be taken out and waited as time goes by.
- Do not leave the side of the pieces while they are cooking. The light of the microwave oven will automatically switch on while operational, and let you see the state of the pieces cooked.

### Defrosting:

- Defrosting time may differ depending on the size of the package. Shallow, rectangular packages defrost faster than deep containers.
- Pick apart the pieces that start melting. This way they will melt easier.
- As the amount of food you cooked increase, the time needed will do too. Twice as large a meal will roughly take twice the time. If a potato takes four minutes to cook, two potatoes will take seven minutes or so. However much food you put inside the oven, the amount of microwave created will stay the same. That is, the more food you put in it, the longer it will take to cook.

## Liquid content

- As microwaves are sensitive against liquids, liquid content will effect the cooking time. Meals with natural liquid ingredients (eg. vegetables, fish and poultry) will cook faster and easier. It is recommended to add water when cooking dry foods such as rice and legumes.
- It should be noted that the microwave removes moisture, so before cooking drier items such as certain vegetables, you should soak them with a little water or wrap them so that they retain their moisture.
- When cooking foods that contain very little water (like defrosting bread, popping popcorn), evaporation happens very quickly. In this case, the oven works as if it is empty and the food may burn. In such a case, the oven and the container may be damaged. Therefore, only set it to the required cooking time, and keep a close eye on the oven during the cooking process.

## Steam

- Moisture in food can sometimes cause steam to form inside the oven while it is operating. This is normal.

## Sugar

- Follow the recommendations in the microwave recipe book when making dishes with a very high sugar content, such as puddings and pies. If you exceed the recommended cooking time, it may cause the food to burn or damage the oven.

## Food density

- Lighter, porous foods like bread and cake will cook faster than heavier, dense foods like roasts and stews. Be careful when heating porous items without hard, dry surfaces in the microwave.

## Bone and fat content

- Bones transmit the heat and fat cooks faster than the meat. When cooking pieces of meat that contain bone and fat, make sure they are spread equally and are not over cooked.

## Color of the dish

- Meat or poultry that has been cooked for fifteen minutes or longer will darken slightly with its own fat. To prepare a quickly-cooked meal with an appetizing and toasty look, you can coat it with barbecue or soy sauce. If you use a small amount of this sauce, it will not affect the taste of the food itself.

## Reducing the internal pressure of food

- Most food are covered with skin. As they cook, pressure builds up inside them and this can cause them to burst. To prevent this, the skin must be punctured with a fork or knife. You should apply this process on potatoes, chicken livers, mussels, egg yolks, sausages, and certain types of fruit and vegetables.

## Turning and stirring of pieces while cooking

- Stirring is important while cooking with microwave. While cooking in a regular manner, food are stirred so that they do not mash together. While cooking in a microwave on the other hand, the food are stirred to ensure that the heat spreads it equally. As the outer layer will heat faster than the inside, always stir from the outside in.
- Large, long pieces such as roasts and whole poultry should be turned over to ensure even top and bottom cooking. Thus you may also need to turn cut meat and chicken over.
- Turning and stirring the pieces while cooking is important to ensure they are cooked evenly throughout.

## Different cooking times

- Initially, always try the minimum cooking time and control if the meal is ready or not. The cooking times given in this manual are close estimates. Cooking times may vary depending on the size and type of food and container.

## Waiting time

- Let the food sit for a while after taking it out of the oven. When defrosting, cooking and reheating, letting the pieces sit for a

while will always give better results. This is because the heat being evenly distributed over the food.

- In the microwave oven, food will continue to cook even after the oven is turned off. The waiting time will increase the temperature of the food between 3°C and 8°C. This process is carried out not by the microwave oven, but by the heat in the food. The waiting time varies according to the type of food. Sometimes this time can be as short as taking the food out of the oven and putting it on the table. Or it may take up to ten minutes for large pieces.
- Remove the food from the plastic package before cooking or defrosting it. In certain exceptional cases, you may need to cover the food with a special nylon stretch film.
- It is especially recommended that some dishes such as meat, chicken, bread, cakes and cream sauce be taken out of the oven before they are fully cooked and left to wait until they are fully cooked.

## 6.2 General Warnings About Cooking in the Oven

- While opening the oven door during or after cooking, hot-burning steam may emerge. The steam may burn your hand, face and / or eyes. When opening the oven door, stay away.
- Intense steam generated during cooking may form condensed water drops on the interior and exterior of the oven and on the upper parts of the furniture due to the temperature difference. This is a normal and physical occurrence.
- The cooking temperature and time values given for foods may vary depending on the recipe and amount. For this reason, these values are given as ranges.
- Always remove unused accessories from the oven before you start cooking. Accessories that will remain in the oven may prevent your food from being cooked at the correct values.

- For foods that you will cook according to your own recipe, you can reference similar foods given in the cooking tables.
- Using the supplied accessories ensures you get the best cooking performance. Always observe the warnings and information provided by the manufacturer for the external cookware you will use.
- Cut the greaseproof paper you will use in your cooking in suitable sizes to the container you will cook. Greaseproof papers that are overflowing from the container can create a risk of burns and affect the quality of your cooking. Use the greaseproof paper you will use in the temperature range specified.
- For good cooking performance, place your food on the recommended correct shelf. Do not change the shelf position during cooking.

### 6.2.1 Pastries and oven food

#### General Information

- We recommend using the accessories of the product for a good cooking performance. If you are going to use an external cookware, prefer dark, non-sticking and heat resistant ware.
- If preheating is recommended in the cooking table, be sure to put your food in the oven after preheating.
- If you are going to cook using cookware on the wire grill, place it in the middle of the wire grill, not near the back wall.
- All materials used in making pastry should be fresh and at room temperature.
- The cooking status of the foods may vary depending on the amount of food and the size of the cookware.
- Metal, ceramic and glass moulds extend the cooking time and the bottom surfaces of pastry foods do not brown evenly.
- If you are using baking paper, a small browning can be observed on the bottom surface of the food. In this situation, you may have to extend your cooking period by approximately 10 minutes.



- The values specified in the cooking tables are determined as a result of the tests carried out in our laboratories. Values suitable for you may differ from these values.
- Place your food on the appropriate shelf recommended in the cooking table. Refer to the bottom shelf of the oven as shelf 1.

### Tips for baking cakes

- If the cake is too dry, increase the temperature by 10°C and shorten the baking time.
- If the cake is moist, use a small amount of liquid or reduce the temperature by 10°C.
- If the top of the cake is burnt, put it on the lower shelf, lower the temperature and increase the baking time.
- If the inside of the cake is cooked well, but outside is sticky, use less liquid, decrease the temperature and increase the cooking time.

### Hints for pastry

- If the pastry is too dry, increase the temperature by 10 °C and shorten the cooking time. Wet the dough sheets with a sauce consisting of milk, oil, egg and yoghurt mixture.
- If the pastry is getting cooked slowly, make sure that the thickness of the pastry you have prepared does not overflow the tray.
- If the pastry is browned on the surface but the bottom is not cooked, make sure that the amount of sauce you will use for the pastry is not too much at the bottom of the pastry. For an even browning, try to spread the sauce evenly between the dough sheets and the pastry.
- Bake your pastry in the position and temperature appropriate to the cooking table. If the bottom is still not browned enough, place it on a bottom shelf for the next cooking.

### Cooking table for pastries and oven foods

Food	Accessory to be used	Operating function	Shelf position	Temperature (°C)	Cooking time (min) (approx.)
Cake on the tray	Standard tray *	Top and bottom heating	2	180	20 ... 30
Small cakes	Standard tray *	Top and bottom heating	2	150	25 ... 35
Small cakes	Standard tray *	Fan Heating	1	150 ... 160	35 ... 50
Sponge cake	Round cake mould, 26 cm in diameter with clamp on wire grill **	Top and bottom heating	2	160	30 ... 40
Sponge cake	Round cake mould, 26 cm in diameter with clamp on wire grill **	Fan Heating	1	160	35 ... 45
Cookie	Pastry tray *	Top and bottom heating	2	170	25 ... 35
Cookie	Pastry tray *	Fan Heating	1	170	30 ... 40
Pastry	Standard tray *	Top and bottom heating	2	180	35 ... 45
Bun	Standard tray *	Top and bottom heating	2	200	20 ... 30
Bun	Standard tray *	Fan Heating	1	180	20 ... 30
Whole bread	Standard tray *	Top and bottom heating	2	200	30 ... 40
Whole bread	Standard tray *	Fan Heating	1	200	30 ... 40

Food	Accessory to be used	Operating function	Shelf position	Temperature (°C)	Cooking time (min) (approx.)
Lasagne	Glass / metal rectangular container on wire grill **	Top and bottom heating	1 or 2	200	30 ... 40
Apple pie	Round black metal mould, 20 cm in diameter on wire grill **	Top and bottom heating	2	180	50 ... 60
Pizza	Standard tray *	Top and bottom heating	2	200 ... 220	10 ... 20
Pizza	Standard tray *	Pizza function	2	200 ... 220	10 ... 15

Preheating is recommended for all food.

\*These accessories may not be included with your product.

\*\*These accessories are not included with your product. They are commercially available accessories.

### Cooking table with operating function “Eco fan heating”

- Do not change the temperature setting after starting cooking in the operating function “Eco fan heating”.

- Do not open the oven door when cooking in the “Eco fan heating” operating function. If the door does not open, the internal temperature is optimized to save energy, and this temperature may differ from what is shown on the display.
- Do not preheat in the “Eco fan heating” operating function.

Food	Accessory to be used	Shelf position	Temperature (°C)	Cooking time (min) (approx.)
Small cakes	Standard tray *	2	160	30 ... 40
Cookie	Standard tray *	2	180	30 ... 40
Pastry	Standard tray *	2	200	45 ... 55
Bun	Standard tray *	2	200	35 ... 45

\* These accessories may not be included with your product.

## 6.2.2 Meat, Fish and Poultry

### The key points on grilling

- Seasoning it with lemon juice and pepper before cooking whole chicken, turkey and large pieces of meat will increase cooking performance.
- It takes 15 to 30 minutes more to cook boned meat than fillet by frying.
- You should calculate about 4 to 5 minutes of cooking time per centimetre of the meat thickness.

- After the cooking time is expired, keep the meat in the oven for approximately 10 minutes. The juice of the meat is better distributed to the fried meat and does not come out when the meat is cut.
- Fish should be placed on the medium or low level shelf in a heat resistant plate.
- Cook the recommended dishes in the cooking table with a single tray.

## Cooking table for meat, fish and poultry

Food	Accessory to be used	Operating function	Shelf position	Temperature (°C)	Cooking time (min) (approx.)
Steak (whole) / Roast (1 kg)	Standard tray *	"3D" function	1	15 mins. 250/max, after 180 ... 190	60 ... 80
Lamb's shank (1,5-2 kg)	Standard tray *	"3D" function	1	170	85 ... 110
Fried chicken (1,8-2 kg)	Wire grill * Place one tray on a lower shelf.	"3D" function	1	15 mins. 250/max, after 190	70 ... 90
Turkey (5.5 kg)	Standard tray *	"3D" function	1	25 mins. 250/max, after 180 ... 190	150 ... 210
Fish	Wire grill * Place one tray on a lower shelf.	"3D" function	1	200	20 ... 30

Preheating is recommended for all food.

\*These accessories may not be included with your product.

\*\*These accessories are not included with your product. They are commercially available accessories.

### 6.2.3 Grill

Red meat, fish and poultry meat quickly turns brown when grilled, holds a beautiful crust and does not dry out. Fillet meats, skewer meats, sausages as well as juicy vegetables (tomatoes, onions, etc.) are particularly suitable for grilling.

#### General warnings

- Food not suitable for grilling carries a fire hazard. Grill only food that is suitable for heavy grill fire. Also, do not place the food too far in the back of the grill. This is the hottest area and fatty foods may catch fire.
- **Close the oven door during grilling. Never grill with the oven door open. Hot surfaces may cause burns!**

#### The key points of the grill

- Prepare foods of similar thickness and weight as much as possible for the grill.
- Place the pieces to be grilled on the wire grill or wire grill tray by distributing them without exceeding the dimensions of the heater.
- Depending on the thickness of the pieces to be grilled, the cooking times given in the table may vary.
- Slide the wire grill or the wire grill tray to the desired level in the oven. If you are cooking on the wire grill, slide the oven tray to the lower shelf to collect the oils. The oven tray you are going to slide should be sized to cover the entire grill area. This tray may not be supplied with the product. Put some water into the oven tray for easy cleaning.

#### Grill table

Food	Accessory to be used	Shelf position	Temperature (°C)	Cooking time (min) (approx.)
Fish	Wire grill	2	250	20 ... 25
Chicken pieces	Wire grill	2	250	25 ... 35
Meatball (veal) - 12 amount	Wire grill	2	250	20 ... 30
Lamb chop	Wire grill	2	250	20 ... 25
Steak - (meat cubes)	Wire grill	2	250	25 ... 30
Veal chop	Wire grill	2	250	25 ... 30

Food	Accessory to be used	Shelf position	Temperature (°C)	Cooking time (min) (approx.)
Vegetable gratin	Wire grill	2	220	20 ... 30
Toast bread	Wire grill	2	250	3 ... 5

It is recommended to preheat for 5 minutes for all grilled food.  
Turn pieces of food after 1/2 of the total grilling time.

## 6.2.4 Test foods

- Foods in this cooking table are prepared according to the EN 60350-1 standard to facilitate testing of the product for control institutes.

### Cooking table for test meals

Food	Accessory to be used	Operating function	Shelf position	Temperature (°C)	Cooking time (min) (approx.)
Shortbread (sweet cookie)	Standard tray *	Top and bottom heating	2	140	20 ... 30
Shortbread (sweet cookie)	Standard tray *	Fan Heating	2	140	15 .. 25
Small cakes	Standard tray *	Top and bottom heating	2	150	25 ... 35
Small cakes	Standard tray *	Fan Heating	1	150 ... 160	35 ... 50
Sponge cake	Round cake mould, 26 cm in diameter with clamp on wire grill **	Top and bottom heating	2	160	30 ... 40
Sponge cake	Round cake mould, 26 cm in diameter with clamp on wire grill **	Fan Heating	1	160	35 ... 45
Apple pie	Round black metal mould, 20 cm in diameter on wire grill **	Top and bottom heating	2	180	50 ... 60

Preheating is recommended for all food.

\*These accessories may not be included with your product.

\*\*These accessories are not included with your product. They are commercially available accessories.

## Grill

Food	Accessory to be used	Shelf position	Temperature (°C)	Cooking time (min) (approx.)
Meatball (veal) - 12 amount	Wire grill	2	250	20 ... 30
Toast bread	Wire grill	2	250	3 ... 5

It is recommended to preheat for 5 minutes for all grilled food.  
Turn pieces of food after 1/2 of the total grilling time.

## 6.2.5 Microwave

- “0 shelf spot” is the oven floor. Do not use it other than for microwave.

- It is recommended to perform microwave cooking in “Shelf position 0”. For uses other than “Shelf position 0”, see cooking.
- Preheating should be done with oven operating modes.

### Cooking table for microwave and combi modes

Food	Operating function	Weight (g)	Shelf position	Accessory to be used	Temperature (°C)	Microwave power (W)	Cooking time (min) (approx.)
Chicken drumstick	Microwave + Turbo	1000	1	Standard tray *	210	600	25 ... 30
Whole chicken	Microwave + Turbo	1500	1	Standard tray *	15 mins. 230 / after	600	32 ... 38
Frozen pizza	Microwave + Pizza	450	1	Standard tray *	230	200	10 ... 15
Turkey leg (bone-in meat)	Microwave + Fan assisted large grill	1000	1	Standard tray *	230	300	28 ... 32
Turkey leg (bone-in meat)	Microwave + Turbo	1000	1	Standard tray *	180	600	25 ... 30
Potato gratin	Microwave + Turbo	1250	1	Round springform pan with a diameter of 20 cm on a standard tray*	180	600	25 ... 30
Dalyan meat-balls	Microwave + Turbo	1800	1	Standard tray *	5 mins. 230 / after 170	300	18 ... 23
Whole fish	Microwave + Fan assisted large grill	1000	1	Standard tray *	250	600	8 ... 14
Breaded fish fingers	Microwave + Turbo	600	1	Standard tray *	230	300	10 ... 15
Sauce meat-balls with potatoes	Microwave + Turbo	1500	1	Standard tray *	210	200	32 ... 40
Ready-to-serve food (chick peas with meat)	Microwave	400	1	Standard tray *	-	600	3 ... 5
Rice dish	Microwave	400	1	Standard tray *	-	600	3 ... 5
Fresh corn (80 g , 17 g oil , 3 g salt )	Microwave	80	0	Lidded Bor-cam (boro-silicate glass-ware) over glass tray **	-	800	8 ... 11
Ready-to-cook packed corn	Microwave	100	2	Glass Tray **	-	800	4 ... 7

Preheating is recommended for all food.

\*These accessories may not be included with your product.

\*\*These accessories are not included with your product. They are commercially available accessories.

## Microwave + Defrost - Tablосу

Food	Weight (g)	Shelf position	Accessory to be used	Microwave power (W)	Thawing time (min) (approx.)	Waiting time (min.)	Suggestion
Whole red meat	250	1	Standard tray *	200	8 ... 10	10	Turn over after half the time
	500	1	Standard tray *	200	12 ... 16	10	Turn over after half the time
Ground meat	100	1	Standard tray *	100	7 ... 11	10	-
	250	1	Standard tray *	200	5 ... 10	10	-
	500	1	Standard tray *	200	8 ... 10	10	Turn over after half the time
Whole chicken	1500	1	Standard tray *	200	25 ... 30	10	Turn over after half the time
Chicken leg	750	1	Standard tray *	300	6 ... 10	10	-
Chicken drumstick	500	1	Standard tray *	300	6 ... 10	10	-
	1000	1	Standard tray *	600	6 ... 10	10	-
Fish	250	1	Standard tray *	200	7 .. 12	5	Turn over after half the time
	500	1	Standard tray *	200	10 ... 15	5	Turn over after half the time
Sausage	300	1	Standard tray *	200	5 ... 10	5	-

\* These accessories may not be included with your product.

## 7 Maintenance and Cleaning

### 7.1 General Cleaning Information

#### General warnings

- Wait for the product to cool before cleaning the product. Hot surfaces may cause burns!
- Do not apply the detergents directly on the hot surfaces. This may cause permanent stains.
- The product should be thoroughly cleaned and dried after each operation. Thus, food residues shall be easily cleaned and these residues shall be prevented from burning when the product is used again later.

Thus, the service life of the appliance extends and frequently faced problems are decreased.

- Do not use steam cleaning products for cleaning.
- Some detergents or cleaning agents cause damage to the surface. Unsuitable cleaning agents are: bleach, cleaning products containing ammonia, acid or chloride, steam cleaning products, descaling agents, stain and rust removers, abrasive cleaning products (cream cleaners, scouring powder, scouring cream, abras-

ive and scratching scrubber, wire, sponges, cleaning cloths containing dirt and detergent residues).

- No special cleaning material is needed in the cleaning made after each use. Clean the appliance using dishwashing detergent, warm water and a soft cloth or sponge and dry it with a dry cloth.
- Be sure to completely wipe off any remaining liquid after cleaning and immediately clean any food splashing around during cooking.
- Do not wash any component of your appliance in a dishwasher.

### **Inox - stainless surfaces**

- Do not use acid or chlorine-containing cleaning agents to clean stainless-inox surfaces and handles.
- Stainless-inox surface may change colour in time. This is normal. After each operation, clean with a detergent suitable for the stainless or inox surface.
- Clean with a soft soapy cloth and liquid (non-scratching) detergent suitable for inox surfaces, taking care to wipe in one direction.
- Remove lime, oil, starch, milk and protein stains on the glass and inox surfaces immediately without waiting. Stains may rust under long periods of time.
- Cleaners sprayed/applied to the surface should be cleaned immediately. Abrasive cleaners left on the surface cause the surface to turn white.

### **Enamelled surfaces**

- After each use, clean the enamel surfaces using dishwashing detergent, warm water and a soft cloth or sponge and dry them with a dry cloth.
- For difficult stains, an oven and grill cleaner recommended on the website of your product brand and a non-scratching scouring pad can be used. Do not use an external oven cleaner.
- The oven must cool down before cleaning the cooking area. Cleaning on hot surfaces shall create both fire hazard and damage the enamel surface.

### **Catalytic surfaces**

- The side walls in the cooking area can only be covered with enamel or catalytic walls. It varies by model.
- The catalytic walls have a light matte and porous surface. The catalytic walls of the oven should not be cleaned.
- Catalytic surfaces absorb oil thanks to its porous structure and start to shine when the surface is saturated with oil, in this case it is recommended to replace the parts.

### **Glass surfaces**

- When cleaning glass surfaces, do not use hard metal scrapers and abrasive cleaning materials. They can damage the glass surface.
- Clean the appliance using dishwashing detergent, warm water and a microfiber cloth specific for glass surfaces and dry it with a dry microfiber cloth.
- If there is residual detergent after cleaning, wipe it with cold water and dry with a clean and dry microfiber cloth. Residual detergent may damage the glass surface next time.
- Under no circumstances should the dried-up residue on the glass surface be cleaned off with serrated knives, wire wool or similar scratching tools.
- You can remove the calcium stains (yellow stains) on the glass surface with the commercially available descaling agent, with a descaling agent such as vinegar or lemon juice.
- If the surface is heavily soiled, apply the cleaning agent on the stain with a sponge and wait a long time for it to work properly. Then clean the glass surface with a wet cloth.
- Discolorations and stains on the glass surface are normal and not defects.

### **Plastic parts and painted surfaces**

- Clean plastic parts and painted surfaces using dishwashing detergent, warm water and a soft cloth or sponge and dry them with a dry cloth.

- Do not use hard metal scrapers and abrasive cleaners. They may damage the surfaces.
- Ensure that the joints of the components of the product are not left damp and with detergent. Otherwise, corrosion may occur on these joints.

## 7.2 Cleaning Accessories

Do not put the product accessories in a dishwasher unless otherwise stated in the user's manual.

## 7.3 Cleaning the Control Panel

- When cleaning the panels with knob-control, wipe the panel and knobs with a damp soft cloth and dry with a dry cloth. Do not remove the knobs and gaskets underneath to clean the panel. The control panel and knobs may be damaged.
- While cleaning the inox panels with knob control, do not use inox cleaning agents around the knob. The indicators around the knob can be erased.
- Clean the touch control panels with a damp soft cloth and dry with a dry cloth. If your product has a key lock feature, set the key lock before performing control panel cleaning. Otherwise, incorrect detection may occur on the keys.

## 7.4 Cleaning the inside of the oven (cooking area)

Follow the cleaning steps described in the "General Cleaning Information" [▶ 46] section according to the surface types in your oven.

### Cleaning the side walls of the oven

The side walls in the cooking area can only be covered with enamel or catalytic walls. It varies by model. If there is a catalytic wall, refer to the "Catalytic surfaces" [▶ 47] section for information.

If your product is a wire shelf model, remove the wire shelves before cleaning the side walls. Then complete the cleaning as de-

scribed in the "General Cleaning Information" [▶ 46] section according to the side wall surface type.

### To remove the side wire shelves:

- Hold the side wire shelf at the bottom. Pull it down and free it from the bottom slots.
- Pull the side wire shelf in the opposite direction of the side wall.
- Completely remove the side wire shelf by pulling it up.

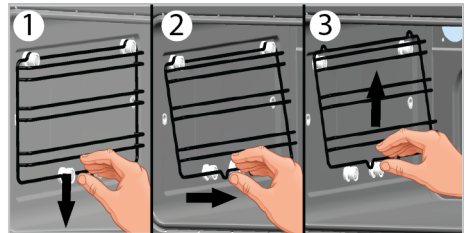

## 7.5 Cleaning the Oven Lamp

In the event that the glass door of the oven lamp in the cooking area becomes dirty; clean using dishwashing detergent, warm water and a soft cloth or sponge and dry with a dry cloth. In case of oven lamp failure, you can replace the oven lamp by following the sections that follow.

### Replacing the oven lamp

#### General Warnings

- To avoid the risk of electric shock before replacing the oven lamp, disconnect the product and wait for the oven to cool. Hot surfaces may cause burns!
- This oven is powered by an incandescent lamp with less than 40 W, less than 60 mm in height, less than 30 mm in diameter, or a halogen lamp with G9 sockets with less than 60 W power. Lamps are suitable for operation at temperatures above 300 °C. Oven lamps are available from Authorised Services or licensed technicians. This product contains a G energy class lamp.
- The position of the lamp may differ from that is shown in the figure.



- The lamp used in this product is not suitable for use in the lighting of home rooms. The purpose of this lamp is to help the user see food products.
- The lamps used in this product must withstand extreme physical conditions such as temperatures above 50 °C.

**If your oven has a round lamp,**

- Disconnect the product from the electricity.
- Remove the glass cover by turning it counter clockwise.

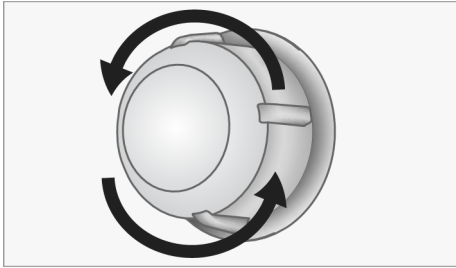

- If your oven lamp is type (A) shown in the figure below, rotate the oven lamp as shown in the figure and replace it with a new one. If it is type (B) model, pull it out as shown in the figure and replace it with a new one.

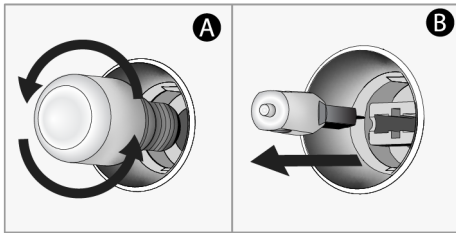

- Refit the glass cover.

**If your oven has a square lamp,**

- Disconnect the product from the electricity.
- Remove the wire shelves according to the description.

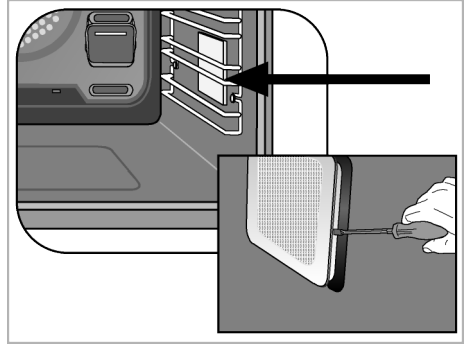

- Lift the lamp's protective glass cover with a screwdriver.
- If your oven lamp is type (A) shown in the figure below, rotate the oven lamp as shown in the figure and replace it with a new one. If it is type (B) model, pull it out as shown in the figure and replace it with a new one.

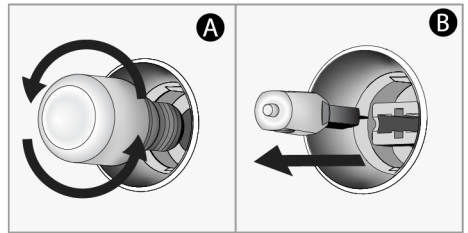

- Refit the glass cover and wire shelves.

## 8 Troubleshooting

If the problem persists after following the instructions in this section, contact your vendor or an Authorized Service. Never try to repair your product yourself.

**Steam is emanated while the oven is working.**

- It is normal to see vapour during operation. >>> This is not an error.

**Water droplets appear while cooking**

- The steam generated during cooking condenses when it comes into contact with cold surfaces outside the product and may form water droplets. >>> This is not an error.

**Metal sounds are heard while the product is warming and cooling.**

- Metal parts may expand and make sounds when heated. >>> This is not an error.

**The product does not work.**

- Fuse may be faulty or blown. >>> Check the fuses in the fuse box. Change them if necessary or reactivate them.
- The appliance may not be plugged to the (grounded) outlet. >>> Check if the appliance is plugged in to the outlet.
- (If there is timer on your appliance) Keys on the control panel do not work. >>> If your product has a key lock, the key lock may be enabled, disable the key lock.

**Oven light is not on.**

- Oven lamp may be faulty. >>> Replace oven's lamp.
- No electricity. >>> Ensure the mains is operational and check the fuses in the fuse box. Change the fuses if necessary or reactivate them.

**Oven is not heating.**

- The oven may not be set to a specific cooking function and/or temperature. >>> Set the oven to a specific cooking function and/or temperature.
- For the models with timer, the time is not set. >>> Set the time.
- No electricity. >>> Ensure the mains is operational and check the fuses in the fuse box. Change the fuses if necessary or reactivate them.
- The oven door may be open. >>> Make sure the oven door is closed. If the oven door remains open for more than 5 minutes, the time setting made for cooking is cancelled and heaters do not work.

**(For models with timer) The timer display flashes or the timer symbol is left open.**

- There has been a power outage before. >>> Set the time / Turn off the product function knobs and again switch it to the desired position.

**The microwave does not work.**

- It was not properly plugged in. >>> Plug the cord.
- There might be an object between the door and the oven. >>> Remove the object and completely shut the lid.

**The microwave makes strange noises whilst operating.**

- There is some electrical arch inside, caused by a metal object in the oven. >>> Remove the metal object from the oven.
- The hardware of the oven is touching the wall. >>> Cut its touch with the oven wall.
- There is a loose fork, knife or a cooking tool in the oven. >>> Remove the fork, knife or a cooking tool from the oven.

**The meal does not heat up, or it is too slow.**

- The correct operation time and/or power level is not chosen. >>> Choose the right cooking power and time for the type of meal you are heating.
- The quantity of food may be too much or it may be too cold. >>> Set additional cooking time. Constantly check for the meal not to burn.
- There is a loose fork, knife or a cooking tool in the oven. >>> Remove the fork, knife or a cooking tool from the oven.

**The meal is too hot, dry or burnt.**

- The correct operation time and/or power level is not chosen. >>> Check if you have chosen the right cooking power and time for the type of meal you are heating. Call the authorized service if your appliance is damaged.

**Some sounds come from the oven once the cooking time is over.**

- Cooling fan might be working. >>> This is not an error. The cooling fan continues operating after the oven shuts down. When the temperature is low enough, the fan shuts down automatically.

**After cooking starts ► symbol flashes on the display and there is an audible warning.**

- The oven door may be open. >>> Make sure the oven door is completely closed. Contact the authorized service if the fault continues.

## BEKO UK AND IRELAND STANDARD MANUFACTURER GUARANTEE TERMS AND CONDITIONS

Your new Beko product is guaranteed against faulty materials, defective components or manufacturing defects.

The standard guarantee starts from the date of original purchase of the product, and lasts for a period of twelve (12) months unless Beko plc (the “Manufacturer”) agrees to extend the guarantee for the product in writing.  
If you have purchased an American style Fridge freezer, the standard guarantee starts from the date of original purchase of the product, and lasts for a period of twenty four (24) months unless Beko plc (the “Manufacturer”) agrees to extend the guarantee for the product in writing.

If you have any questions about the guarantee on your product (including how long it is valid), please contact your retailer or our contact centre on 0333 207 9710 (UK and Northern Ireland) or 01 862 3411 (Republic of Ireland)

This guarantee does not in any way diminish or affect your statutory rights in connection with the product. This guarantee is in addition to your statutory rights as a consumer. If you have any questions about these rights, please contact the retailer from which you purchased the product. In certain circumstances, it is possible that your statutory rights may offer additional or higher levels of protection than those offered under the terms of this guarantee.

### What is covered by this guarantee?

- Repairs to the product required as a result of faulty materials, defective components or manufacturing defects.
- Functional replacement parts to repair a product.
- The costs of a Beko Approved Engineer to carry out the repair.

### What is not covered?

- Transit and delivery damage.
- Cabinet or appearance parts, including but not limited to control knobs, flaps and handles.
- Accessories and/or consumable items including but not limited to ice trays, scrapers, cutlery baskets, filters and light bulbs.
- Repairs necessary as a direct or indirect result of:
  - Accidental damage, misuse or abuse of a product.
  - An attempted repair of a product by anyone other than a Beko Approved Engineer (the “Engineer”).
  - Installation or use of a product where such installation or use fails to meet the requirements contained in this guarantee or the User Instructions Booklet.
- Repairs to a product operated at any time on commercial or non-residential household premises (unless we have previously agreed to the installation environment).

This guarantee is limited to the cost of repairing the product. To the extent permitted by law, the Manufacturer does not accept and will not be held liable for any financial loss incurred in connection with the failure of any product to operate in accordance with the expected standards. Such financial loss includes but is not limited to loss arising from:

- Time taken off work.
- Damaged food, clothing or other items.
- Meals taken at restaurants or from takeaways.
- General compensation for inconvenience.

## Important Notes

1. Your product is designed and built for domestic household use only.
2. The guarantee will automatically be void if the product is installed or is used in commercial or non-residential domestic household premises, unless we have previously agreed to the installation environment.
3. The product must be correctly installed, located and operated in accordance with the instructions contained in the User Instructions Booklet provided with your product.
4. Professional installation by a qualified Electrical Domestic Appliance Installer is recommended for all Washing Machines, Dishwashers and Electric Cookers (as incorrect installation may result in you having to pay for the cost of repairing the product).
5. Gas Cookers must be professionally installed by a Gas Safe (or Gas Networks Ireland for Republic of Ireland) registered gas installer.
6. This guarantee is given in respect of products purchased and used within the United Kingdom and the Republic of Ireland.
7. This guarantee is effective from the initial date of purchase of a new product from an authorised retailer and will be void if the product is resold.
8. This guarantee does not apply to graded sales (where the product is purchased as a “second”).
9. Possession of a copy of these terms and conditions does not necessarily mean that a product has the benefit of this guarantee. If you have any questions, please call our Call Centre on the number set out above.
10. The Manufacturer reserves the right to terminate the guarantee if its staff or representatives are subjected to physical or verbal abuse in the course of carrying out their duties.
11. Optional extras, where available (i.e. extendable feet) are supplied on a chargeable basis only.

## Does Beko offer replacements?

This is a repair-only guarantee. On occasion, the Manufacturer may at its sole discretion, replace your product with a new product instead of carrying out a repair. Where a replacement is offered, this would normally be an identical model but when this is not possible, a model of similar specification will be provided. The Manufacturer will cover the costs and arrange for the delivery of the new product and for the return of the old product. Any costs related to disconnecting the faulty product and installing the replacement product will not be borne by the Manufacturer unless previously agreed to in writing. The original guarantee will continue to apply to the replacement product; the new product will not come with a new guarantee.

## When will the repair take place?

Our Engineers work Monday to Friday 9.00am to 5.00pm. Appointments outside these hours may be possible at the sole discretion of the Manufacturer but cannot be guaranteed. Whilst our Engineers will endeavour to minimize inconvenience and to meet requests for specific timed appointments, this cannot be guaranteed. We will not be liable for delays or if it is unable to carry out a repair because a convenient appointment cannot be arranged.

## Will there be any charge for the repairs?

It is your responsibility to provide evidence to the Engineer that your product is covered by this guarantee with a proof of purchase. The Manufacturer reserves the right to charge for the reasonable cost of any service call if:

- You cannot provide evidence that your product is covered by this guarantee.
- Where a service call has been made and the engineer finds that there is no fault with your product.
- That your product has not been installed or operated in accordance with the User Instructions Booklet.
- That the fault was caused by something other than faulty materials, defective components or manufacturing defects.
- For missed appointments.

Payment of these costs are due immediately upon the Engineer providing you with an invoice. The Manufacturer reserves the right to terminate the guarantee if you fail to pay the costs for the service call in a timely manner.

If you are a resident of the United Kingdom, this guarantee will be governed by English law and subject to the English Courts, save where you live in another part of the United Kingdom, in which case the law and courts of that location will apply.

If you are resident in the Republic of Ireland, this guarantee will be governed by Irish law and the Irish courts will have jurisdiction.

This guarantee is provided by Beko plc. Beko House, 1 Greenhill Crescent, Watford, Hertfordshire. WD18 8QU.

Beko plc is registered in England and Wales with company registration number 02415578.

## BEKO UK AND IRELAND BUILT-IN APPLIANCES GUARANTEE TERMS AND CONDITIONS

If you have purchased a built-in or integrated appliance, and registered it within 90 days of purchase by completing the online registration form, then the standard 12 month guarantee will be extended to 24 months, under the same terms and conditions as detailed in our Standard Guarantee Terms and Conditions.

## BEKO UK AND IRELAND PROSMART INVERTER MOTOR GUARANTEE TERMS AND CONDITIONS

This 10 year guarantee relates to Beko products that feature the ProSmart Inverter Motor.

The ProSmart Motor guarantee terms and conditions are in addition to our Standard guarantee terms and conditions detailed in the previous section.

In order to activate the 10 year guarantee you MUST register the appliance within 90 days of the original purchase date. You can register by first visiting [Beko.co.uk/register](http://Beko.co.uk/register) and by following the online instructions.

Beko Free standing appliances come with a 12 month parts and labour guarantee as standard,

Beko Built-in appliances come with a 12 month parts and labour guarantee as standard. This is extended to 24 months, free of charge, upon registration of the appliance. When you register your appliance for additional guarantee, you will automatically activate the ProSmart Motor 10 year guarantee. You do not need to register twice. ([beko.co.uk/guarantee-terms](http://beko.co.uk/guarantee-terms)).

To make a claim against your Beko ProSmart Inverter Motor Guarantee (the "Guarantee"), all customer and product details must be registered with Beko plc using the procedure outlined below.

1. This extra 9 years (for free standing appliances) or 8 years (for built-in or integrated appliances) guarantee is only effective after the expiration of the standard manufacturer's guarantee.
2. It is only valid for the ProSmart Inverter motors of selected washing machines, washer-dryers, tumble dryers and dishwashers. It does not cover any labour charge or any other components of the product. In addition, it is only valid for one replacement of the ProSmart motor during the extra 9-year (for free standing appliances) or 8 year (for built-in appliances) guarantee period.
3. To activate your guarantee, you MUST register your appliance within 90 days of the original purchase date, by visiting [beko.co.uk/register](http://beko.co.uk/register).
4. Customers will receive a unique reference code as proof of guarantee validation by email or post, which must be quoted at the time of a claim being made.
5. Any repair/replacement of the ProSmart Inverter motor must only be carried out by an authorised Beko Service Agent (the "Service Agent").
6. Labour for the repair/replacement of the ProSmart Inverter motor is not included in this guarantee and is chargeable directly by the Service Agent.
7. Any additional components fitted to the product at any time will not be covered by this guarantee and will be chargeable directly by the Service Agent.

8. The guarantee is not transferable and cannot be exchanged for cash.
9. There are no alternative or additional offers to this Guarantee.
10. The guarantee is exclusive of the manufacturer's standard guarantee.
11. The Terms and Conditions shown above are in addition to the standard terms and conditions of your product guarantee. Please read and refer to such Terms and Conditions when making any claim.
12. We may use the information you provide for marketing purposes and to analyse your purchasing preferences. We may keep your information for a reasonable period for these purposes in accordance with the applicable Data Protection Laws and General Data Protection Regulations (GDPR). You can opt into this service during the registration process. Further details are available at <http://www.beko.co.uk/cookie-and-privacy>.
13. These Terms and Conditions are governed by the laws of England and Wales; manufacturer: Beko plc, Beko House, 1 Greenhill Crescent, Watford WD18 8QU. Company Registration Number: 02415578.

#### HOW TO OBTAIN SERVICE FOR YOUR APPLIANCE

Please keep your purchase receipt or other proof of purchase details in a safe place; you will need to have this documentation available should the product require attention under guarantee.

Please take a few moments to complete the details below, as you will need this information when you call us, or to use our online services. When you call us you may be required to input your serial number into your telephone keypad. For help please visit [beko.co.uk/support/model-finder](http://beko.co.uk/support/model-finder)

- The product model number is printed on the Operating Instruction Booklet / User guide
- The product model and serial number is printed on the Rating Label affixed to the appliance.
- The Retailer (Purchased from) and Date of purchase will be printed on your purchase receipt or other proof of purchase paperwork

Recording of these details alone will not count as proof of purchase. A valid proof of purchase is required for requesting service under guarantee.

Model number	Serial number	Purchased from	Date of purchase



## **For service under guarantee or for product advice please call our Contact centre**

Before requesting service please check the troubleshooting guide in the Operating Instructions booklet, as a charge may be levied where no fault is found, and even though your product may still be under guarantee.

After arranging service the area around the product must be easily accessible to the Engineer, without the need for cabinets or furniture to be removed or moved.

It is your responsibility to ensure our Engineers have a clean and safe environment to carry out any repairs.

Please have your Model number and Serial number available when you call us, as you may be required to input your serial number into your telephone keypad during your call.
---

UK Mainland & Northern Ireland:

# 0333 207 9710

Landline or mobile calls to 0333 numbers cost no more than calls to geographic numbers 01 or 02, and are charged at the basic rate. Calls from landlines and mobiles are included in free call packages but please check with your telephone service provider for exact call charges.

Republic of Ireland:

# 01 862 3411

### **Service once the manufacturers guarantee has expired**

If you have purchased an extended guarantee please refer to the instructions contained within the extended guarantee agreement document, otherwise please call us using the appropriate number above, where service can be obtained at a charge.

Should you experience any difficulty in obtaining service please call us on **0333 207 9710** or **01 862 3411**

### **Contact us through our website**

Send us a secure message through our online contact us form. Please visit our website, click Contact Us and choose a product support topic from the list of options. Complete the required details and click send message.

### **Product registrations**

For UK registrations please visit [beko.co.uk/register](http://beko.co.uk/register) and for the Republic of Ireland visit [beko.ie/register](http://beko.ie/register).





