

# Washing Machine

## User manual



WTL 10019 UKW

EN

Document Number = 2310810090

**beko**

# Please read this user manual first!



Dear Customer,

Thank you for preferring an Beko product. We hope that you get the best results from your product which has been manufactured with high quality and state-of-the-art technology. Therefore, please read this entire user manual and all other accompanying documents carefully before using the product and keep it as a reference for future use. If you handover the product to someone else, give the user manual as well. Follow all warnings and information in the user manual.

Remember that this user manual is also applicable for several other models. Differences between models will be identified in the manual.

## Explanation of symbols

Throughout this user manual the following symbols are used:

	Important information or useful hints about usage.
	Warning for hazardous situations with regard to life and property.
	Warning for electric shock.
	Packaging materials of the product are manufactured from recyclable materials in accordance with our National Environment Regulations.

Do not dispose of the packaging materials together with the domestic or other wastes. Take them to the packaging material collection points designated by the local authorities.



This product was manufactured using the latest technology in environmentally friendly conditions.

## TABLE OF CONTENTS

<b>1 Important instructions for safety and environment</b>	<b>4</b>	<b>5 Operating the product</b>	<b>18</b>
1.1 General safety . . . . .	4	5.1 Control panel . . . . .	18
1.2 Intended use . . . . .	5	5.2 Preparing the machine . . . . .	19
1.3 Children's safety. . . . .	5	5.3 Main programmes . . . . .	20
1.4 Package information. . . . .	6	5.4 Auxiliary function selection . . . . .	22
1.5 Disposing of the waste product. . . . .	6	<b>6 Maintenance and cleaning</b>	<b>23</b>
1.6 Compliance with WEEE Directive. . . . .	6	6.1 Cleaning the detergent drawer . . . . .	23
<b>2 Your washing machine</b>	<b>7</b>	6.2 Cleaning the body and control panel . . . . .	23
2.1 Overview . . . . .	7	6.3 Cleaning the water intake filters . . . . .	23
2.2 Technical specifications . . . . .	8	6.4 Draining remaining water and cleaning the pump filter. . . . .	24
<b>3 Installation</b>	<b>9</b>	<b>7 Troubleshooting</b>	<b>25</b>
3.1 Appropriate installation location. . . . .	9		
3.2 Connecting water supply. . . . .	9		
3.3 Connecting to the drain. . . . .	10		
3.3.1 Connecting to the drain without pump . . . . .	10		
3.3.2 Connecting to the drain with pump. . . . .	11		
3.4 Adjusting the feet . . . . .	11		
3.5 Electrical connection. . . . .	12		
3.6 Connection of inlet hose connector and tap	12		
3.7 Connecting to the water supply. . . . .	13		
3.8 Using detergent /softener and bleach nector	13		
3.9 Put rat guard into the machine. . . . .	13		
<b>4 Preparation</b>	<b>14</b>		
4.1 Sorting the laundry. . . . .	14		
4.2 Preparing laundry for washing. . . . .	15		
4.3 Things to be done for energy saving . . . . .	15		
4.4 Correct load capacity . . . . .	16		
4.5 Loading the laundry . . . . .	16		
4.6 Using detergent and softener . . . . .	16		
4.6.1 Advanced detergent drawer. . . . .	17		
4.6.2 Simple detergent drawer . . . . .	17		

# 1 Important instructions for safety and environment

This section contains safety instructions that will help protect from risk of personal injury or property damage. Failure to follow these instructions shall void any warranty.

## 1.1 General safety

- This product can be used by children at and above 8 years old and by persons whose physical, sensory or mental capabilities were not fully developed or who lack experience and knowledge provided that they are supervised or trained on the safe usage of the product and the risks it brings out. Children must not play with the product. Cleaning and maintenance works should not be performed by children unless they are supervised by someone.
- Never place the product on a carpet-covered floor. Otherwise, lack of airflow beneath the machine will cause electrical parts to overheat. This will cause problems with your product.
- If the product has a failure, it should not be operated unless it is repaired by the Authorized Service Agent. There is the risk of electric shock!
- This product is designed to resume operating in the event of powering on after a power interruption. If you wish to cancel the programme, see "Cancelling the programme" section.
- Connect the product to a grounded outlet protected by a 6 A fuse. Do not neglect to have the grounding installation made by a qualified electrician. Our company shall not be liable for any damages that will arise when the product is used without grounding in accordance with the local regulations.
- The water supply and draining hoses must be securely fastened and remain undamaged. Otherwise, there is the risk of water leakage.
- Never remove the filter while there is still water in the drum. Otherwise, risk of flooding and injury from hot water will occur.
- Unplug the product when not in use.
- Never wash the product by spreading or pouring water onto it! There is the risk of electric shock!
- Never touch the plug with wet hands! Never unplug by pulling on the cable, always pull out by grabbing the plug.
- Use detergents, softeners and supplements suitable for automatic washing machines only.
- Follow the instructions on the textile tags and on the detergent package.
- The product must be unplugged during installation, maintenance, cleaning and repairing procedures.

## Important instructions for safety and environment

- Always have the installation and repairing procedures carried out by the **Authorized Service Agent**. Manufacturer shall not be held liable for damages that may arise from procedures carried out by unauthorized persons.
- If the supply cord is damaged, it must be replaced by the manufacturer, its service agent or similarly qualified persons in order to avoid a hazard.
- If the power cable is damaged, it must be replaced by the manufacturer, after sales service or a similarly qualified person (preferably an electrician) or someone designated by the importer in order to avoid possible risks.
- Place the product on a rigid, flat and level surface.
- Do not place it on a long-pile rug or similar surfaces.
- Do not place the product on a high platform or near the edge on a cascaded surface.
- Do not place the product on the power cable.
- Never use sponge or scrub materials. These will damage the painted, chrome plated and plastic surfaces.

### 1.2 Intended use

- This product has been designed for domestic use. It is not suitable for commercial use and it must not be used out of its intended use.



- The product must only be used for washing and rinsing of laundry that are marked accordingly.
- The manufacturer waives any responsibility arisen from incorrect usage or transportation.
- The service life of your product is 10 years. During this period, original spare parts will be available to operate the appliance properly.

### 1.3 Children's safety

- Packaging materials are dangerous to children. Keep packaging materials in a safe place away from reach of the children.
- Electrical products are dangerous for the children. Keep children away from the product when it is in use. Do not let them to tamper with the product. Use child lock to prevent children from intervening with the product.

## Important instructions for safety and environment

- Do not forget to close the lid when leaving the room where the product is located.
- Store all detergents and additives in a safe place away from the reach of the children by closing the cover of the detergent container or sealing the detergent package.
- Children of less than 3 years should be kept away unless continuously supervised.

### 1.4 Package information

- Packaging materials of the product are manufactured from recyclable materials in accordance with our National Environment Regulations. Do not dispose of the packaging materials together with the domestic or other wastes. Take them to the packaging material collection points designated by the local authorities.

### 1.5 Disposing of the waste product

- This product has been manufactured with high quality parts and materials which can be reused and are suitable for recycling. Therefore, do not dispose the product with normal domestic waste at the end of its service life. Take it to a collection point for the recycling of electrical and electronic equipment. Please consult your local authorities to learn the nearest collection point. Help protect the environment and natural resources by recycling used products. For children's safety, cut the power cable and break the locking mechanism of the lid so that it will be non-functional before disposing of the product.

### 1.6 Compliance with WEEE Directive



This product complies with EU WEEE Directive (2012/19/EU). This product bears a classification symbol for waste electrical and electronic equipment (WEEE).

This product has been manufactured with high quality parts and materials which can be reused and are suitable for recycling. Do not dispose of the waste product with normal domestic and other wastes at the end of its service life. Take it to the collection center for the recycling of electrical and electronic equipment. Please consult your local authorities to learn about these collection centers.

### Compliance with RoHS Directive:

The product you have purchased complies with EU RoHS Directive (2011/65/EU). It does not contain harmful and prohibited materials specified in the Directive.

## 2 Your washing machine

### 2.1 Overview



- 1- Drain hose
- 2- Loading door
- 3- Power cable
- 4- Detergent drawer

- 5- Control panel
- 6- Filter cap
- 7- Adjustable feet

## Your washing machine

### 2.2 Technical specifications

Models (EN)	WTL 10019 UKW
Maximum dry laundry capacity (kg)	8
Height (cm)	94
Width (cm)	56.5
Depth (cm)	58
Net weight ( $\pm 4$ kg.)	38
Electrical input (V/Hz)	220-240 V ~ / 50Hz
Total power (W)	300-340
Spin speed (rpm/ min., max.)	750
Main model code	9919



Technical specifications may be changed without prior notice to improve the quality of the product.



Figures in this manual are schematic and may not match the product exactly.



Values stated on the product labels or in the documentation accompanying it are obtained in laboratory conditions in accordance with the relevant standards. Depending on operational and environmental conditions of the product, these values may vary.



## 3 Installation

Refer to the nearest Authorised Service Agent for installation of the product. To make the product ready for use, review the information in the user manual and make sure that the electricity, tap water supply and water drainage systems are appropriate before calling the Authorized Service Agent. If they are not, call a qualified technician and plumber to have any necessary arrangements carried out.



Preparation of the location and electrical, tap water and waste water installations at the place of installation is under customer's responsibility.



**WARNING:** Installation and electrical connections of the product must be carried out by the Authorized Service Agent. Manufacturer shall not be held liable for damages that may arise from procedures carried out by unauthorized persons.



**WARNING:** Prior to installation, visually check if the product has any defects on it. If so, do not have it installed. Damaged products cause risks for your safety.



Make sure that the water inlet and discharge hoses as well as the power cable are not folded, pinched or crushed while pushing the product into its place after installation or cleaning procedures.

### 3.1 Appropriate installation location

- Place the machine on a rigid floor. Do not place it on a long pile rug or similar surfaces.
- Place the product on a solid and flat floor that has sufficient load carrying capacity!
- Do not place the product on the power cable.
- Do not install the product at places where temperature may fall below 0°C.
- Place the product at least 1 cm away from the edges of other furniture.

### 3.2 Connecting water supply



The water supply pressure required to run the product is between 1 to 10 bars (0.1 – 1 MPa). It is necessary to have 10 – 80 liters of water flowing from the fully open tap in one minute to have your machine run smoothly. Attach a pressure reducing valve if water pressure is higher.



If you are going to use the double water-inlet product as a single (**cold**) water-inlet unit, you must install the supplied stopper to the hot water valve before operating the product. (Applies for the products supplied with a blind stopper group.)



**WARNING:** Models with a single water inlet should not be connected to the hot water tap. In such a case the laundry will get damaged or the product will switch to protection mode and will not operate.



**WARNING:** Do not use old or used water inlet hoses on the new product. It may cause stains on your laundry.

1. Connect the special hoses supplied with the product to the water inlets on the product. Red hose (left) (max. 90 °C) is for hot water inlet, blue hose (right) (max. 25 °C) is for cold water inlet.



**WARNING:** Ensure that the cold and hot water connections are made correctly when installing the product. Otherwise, your laundry will come out hot at the end of the washing process and wear out.

2. Tighten all hose nuts by hand. Never use a tool when tightening the nuts.
3. Open the taps completely after making the hose connection to check for water leaks at the connection points. If any leaks occur, turn off the tap and remove the nut. Retighten the nut carefully after checking the seal. To prevent water leakages and damages caused by them, keep the taps closed when the machine is not in use.

### 3.3 Connecting to the drain

- The end of the drain hose must be directly connected to the wastewater drain or to the washbasin.



**WARNING:** Your house will be flooded if the hose comes out of its housing during water discharge. Moreover, there is risk of scalding due to high washing temperatures! To prevent such situations and to ensure smooth water intake and discharge of the machine, fix the end of the discharge hose tightly so that it cannot come out.

## Installation

### 3.3.2 Connecting to the drain with pump

- The hose should be attached to a height of at least 80 cm, and 100 cm at most.
- In case the hose is elevated after laying it on the floor level or close to the ground (less than 80 cm above the ground), water discharge becomes more difficult and the laundry may come out excessively wet. Therefore, follow the heights described in the figure.

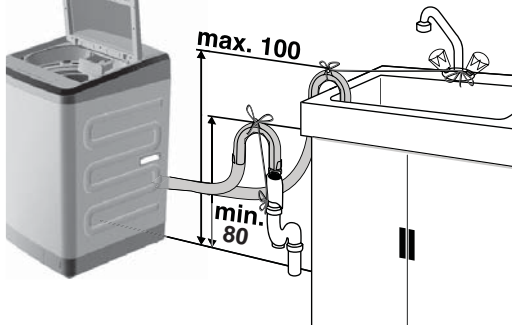

- To prevent flowing of dirty water back into the machine and to allow for easy discharge, do not immerse the hose end into the dirty water or do not drive it in the drain more than 15 cm. If it is too long, cut it short.
- The end of the hose should not be bent, it should not be stepped on and the hose must not be pinched between the drain and the machine.
- If the length of the hose is too short, use it by adding an original extension hose. Length of the hose may not be longer than 3.2 m. To avoid water leak failures, the connection between the extension hose and the drain hose of the product must be fitted well with an appropriate clamp as not to come off and leak.

### 3.4 Adjusting the feet

- The two front feet of washing machine can adjust the positive, when the washing machine is not level, you can up the front of washing machine for a little, then left or right rotation to adjustable the feet, make it level. You can check the level by the help of the indicator on top cover.

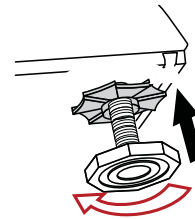
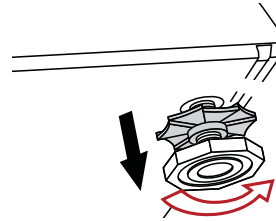

#### Adjusting foot by checking leveler.

- Remarking : there may be no leveler for some types machine.



## Installation

### 3.5 Electrical connection

Connect the product to a grounded outlet protected by a 6 A fuse. Our company shall not be liable for any damages that will arise when the product is used without grounding in accordance with the local regulations.

- Connection must comply with national regulations.
- Power cable plug must be within easy reach after installation.
- If the current value of the fuse or breaker in the house is less than 6 Amps, have a qualified electrician install a 6 Amp fuse.
- The voltage specified in the "Technical specifications" section must be equal to your mains voltage.
- Do not make connections via extension cables or multi-plugs.



**WARNING:** Damaged power cables must be replaced by the Authorized Service Agents.

### Transportation of the product

1. Unplug the product before transporting it.
2. Remove water drain and water supply connections.
3. Drain all water that has remained in the product.
4. Install all styrofoams and then package the machine.



**WARNING:** Packaging materials are dangerous to children. Keep packaging materials in a safe place away from reach of the children.

### 3.6 Connection of inlet hose connector and tap

1. Tighten all hose nuts by hand. Never use a tool when tightening the nuts.

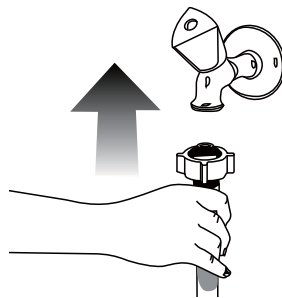

2. Open the taps completely after making the hose connection to check for water leaks at the connection points. If any leaks occur, turn off the tap and remove the nut. Retighten the nut carefully after checking the seal. To prevent water leakages and damages caused by them, keep the taps closed when the machine is not in use.

## Installation

### 3.7 Connecting to the water supply

**Important:**

- The water supply pressure required to run the machine must be 1-10 bar (0,1 – 1 MPa).
- Connect the special hoses supplied with the machine to the water intake valves on the machine.

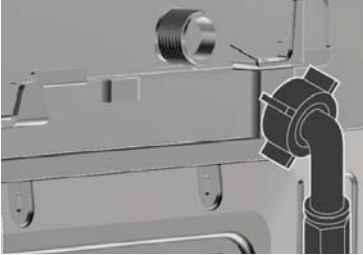

- Applies for the products supplied with a blind stopper group.
- Models with a single water inlet should not be connected to the hot water tap.
- When returning the appliance to its place after maintenance or cleaning, care should be taken not to fold, squeeze or block the hoses.

### 3.8 Using detergent /softener and bleach nector

When using detergent, softener, starch, fabric dye, bleach or limescale remover read the manufacturer's instruction the package carefully and follow the suggested dosage values. Use measuring cup if available.

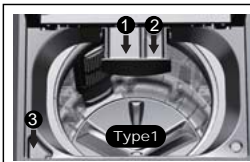

- Type1:
- 1.for laundry detergent
  - 2.for softener
  - 3.for bleach

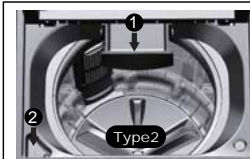

- Type2:
- 1.for laundry detergent
  - 2.for bleach

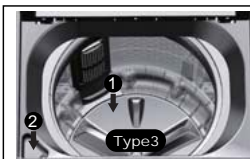

- Type3:
- 1.putting laundry detergent into drum directly
  - 2.for bleach

### 3.9 Put rat guard into the machine

If you want to put rat guard into the machine , you should take the screw out ,then assemble rat guard into the machine ,the last step is putting the screw to fix the rat guard .



(a)



(b)























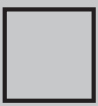

















(c)

## 4 Preparation

### 4.1 Sorting the laundry

- Sort laundry according to type of fabric, colour, and degree of soiling and allowable water temperature.
- Always obey the instructions given on the garment tags.

LAUNDRY WASH SYMBOLS										
 <b>WASH</b>	Machine Wash Symbols									
	Water Temperatures	Maximum	95°C	70°C	60°C	50°C	40°C	30°C		
	Symbol(s)									
 <b>DRYING</b>	Drying Symbols									
	Drying Settings									
 <b>IRON</b>	Iron -									
	Dry or Steam			Iron at high temperature	Iron at medium temperature	Iron at low temperature	Do not iron	Iron without steam		
	Maximum temperature			200 °C	150 °C	110 °C				
 <b>BLEACH</b>	 All bleaches are allowed			 Bleach (sodium hypochlorite) can be used		 Bleach is not allowed		 Only bleaches without chlorine are allowed		

### 4.2 Preparing laundry for washing

- Laundry items with metal attachments such as, underwired bras, belt buckles or metal buttons will damage the machine. Remove the metal pieces or wash the clothes by putting them in a laundry bag or pillow case.
- Take out all substances in the pockets such as coins, pens and paper clips, and turn pockets inside out and brush. Such objects may damage the product or cause noise problem.
- Put small size clothes such as infant's socks and nylon stockings in a laundry bag or pillow case.
- Place curtains in without compressing them. Remove curtain attachment items.
- Fasten zippers, sew loose buttons and mend rips and tears.
- Wash "machine washable" or "hand washable" labeled products only with an appropriate programme.
- Do not wash colours and whites together. New, dark coloured cottons release a lot of dye. Wash them separately.
- Tough stains must be treated properly before washing. If unsure, check with a dry cleaner.
- Use only dyes/colour changers and limescale removers suitable for machine wash. Always follow the instructions on the package.
- Wash trousers and delicate laundry turned inside out.
- Keep laundry items made of Angora wool in the freezer for a few hours before washing. This will reduce pilling.
- Laundry that are subjected to materials such as flour, lime dust, milk powder, etc. intensely must be shaken off before placing into the machine. Such dusts and powders on the laundry may build up on the inner parts of the machine in time and can cause damage.

### 4.3 Things to be done for energy saving

Following information will help you use the product in an ecological and energy-efficient manner.

- Operate the product in the highest capacity allowed by the programme you have selected, but do not overload; see, "Programme and consumption table".
- Always follow the instructions on the detergent packaging.
- Wash slightly soiled laundry at warm or cold water..
- Use faster programmes for small quantities of lightly soiled laundry.
- Do not use soaking and hot water for laundry that is not heavily soiled or stained.
- If you plan to dry your laundry in a dryer, select the longer spin time recommended during washing process.
- Do not use detergent in excess of the amount recommended on the detergent package.

## Preparation

### 4.4 Correct load capacity

The maximum load capacity depends on the type of laundry, the degree of soiling and the washing programme desired.

The machine automatically adjusts the amount of water according to the weight of the loaded laundry.



**WARNING:** Follow the information in the "Programme and consumption table". When overloaded, machine's washing performance will drop. Moreover, noise and vibration problems may occur.

Laundry type	Weight (g)
Bathrobe	1200
Napkin	100
Duvet cover	700
Bed Sheet	500
Pillowcase	200
Tablecloth	250
Towel	200
Hand towel	100
Evening gown	200
Underclothing	100
Men's overalls	600
Men's shirt	200
Men's pajamas	500
Blouses	100

### 4.5 Loading the laundry

1. Open the lid.
2. Place laundry items loosely into the machine.
3. Close the lid and; Ensure all loads inside well distributed.



**WARNING:** In case of misplacing the laundry, noise and vibration problems may occur in the machine.

### 4.6 Using detergent and softener Detergent, softener and other cleaning agents

- Add detergent and softener before starting the washing programme.
- Never leave the detergent drawer open while the washing programme is running!
- Place the detergent bag or the dispensing ball directly among the laundry in the machine if you use them.

#### Choosing the detergent type

The type of detergent to be used depends on the type and colour of the fabric.

- Use different detergents for coloured and white laundry.
- Wash your delicate clothes only with special detergents (liquid detergent, wool shampoo, etc.) used solely for delicate clothes.
- Wash woolens with special detergent made specifically for woolens.



**WARNING:** Use only detergents manufactured specifically for washing machines.

**WARNING:** Do not use soap powder.

#### Adjusting detergent amount

The amount of washing detergent to be used depends on the amount of laundry, the degree of soiling and water hardness.

- Pour the detergent into the main wash compartment of the detergent drawer. If your machine is without detergent drawer, pour the detergent directly over the laundry in the tub.
- Do not use amounts exceeding the dosage quantities recommended on the detergent package to avoid problems of excessive foam, poor rinsing, financial savings and finally, environmental protection.
- Use less detergent for small amounts or lightly soiled clothes.



## Preparation

### Using softeners

Pour the softener into the softener compartment of the detergent drawer. If your machine is without detergent drawer or with simple detergent drawer (detergent drawer that does not include softener department) softener can be put at the dedicated compartment on the balance ring.

- Do not exceed the (>max<>) level marking in the softener compartment.
- If the softener has lost its fluidity, dilute it with water before putting it in the detergent drawer.

### Using liquid detergent

- Liquid detergent stains your clothes when used with Delayed Start function. If you are going to use the Delayed Start function, do not use liquid detergent.

### Using gel and tablet detergent

Apply the following instructions when using tablet, gel and similar detergents.

- If the gel detergent thickness is fluidal, put the gel detergent into the main wash detergent compartment during first water intake.
- If the gel detergent thickness is not fluidal or in the shape of capsule liquid tablet, put it directly into the drum before washing.
- Put tablet detergents into the main wash compartment or directly into the drum before washing.



Tablet detergents may leave residues in the detergent compartment. If you encounter such a case, place the tablet detergent between the laundry, close to the lower part of the drum in future washings.

### Using starch

- Add liquid starch, powder starch or the fabric dye into the softener compartment.
- Do not use softener and starch together in a washing cycle.
- Wipe the inside of the machine with a damp and clean cloth after using starch.

### Using bleaches

- Add the bleaching agent to the dedicated compartment on the top cover.
- Do not use bleaching agent and detergent by mixing them.
- Use just a little amount of bleaching agent and rinse the clothes very well as it causes skin irritation. Do not pour the bleaching agent onto the clothes and do not use it for coloured clothes.

#### 4.6.1 Advanced detergent drawer

The detergent drawer is composed of three compartments:

- (1) for main wash
- (2) for softener
- (\*) in addition, there is siphon piece in the softener compartment.

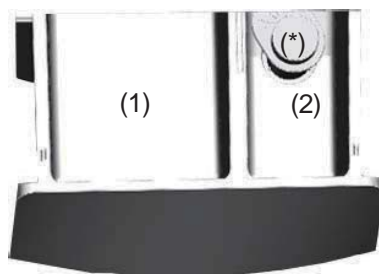

#### 4.6.2 Simple detergent drawer

This detergent drawer has one compartment

- (1) for main wash



## 5 Operating the product

### 5.1 Control panel

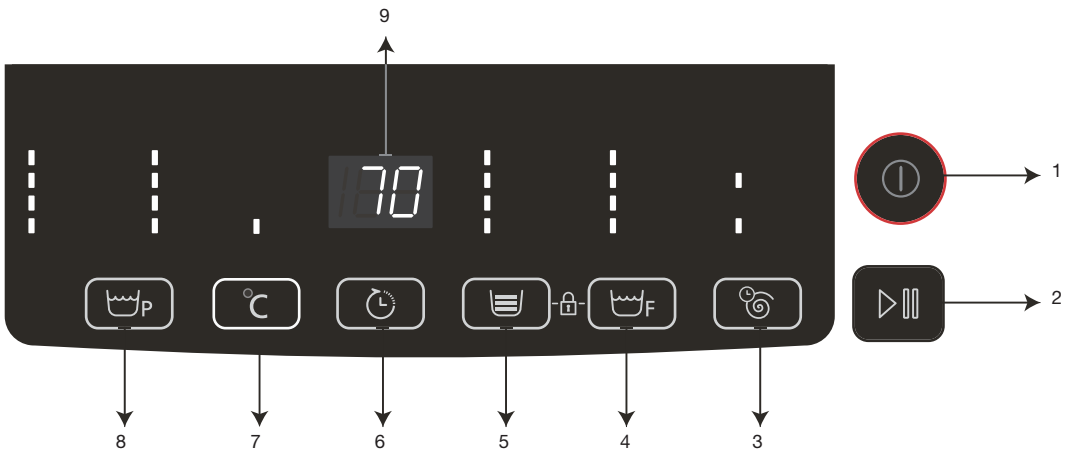

- 1 - On / Off button
- 2 - Start / Pause button
- 3 - Air Turbo button
- 4 - Auxiliary Function button
- 5 - Water Level button
- 6 - Delayed Start Time button
- 7 - Water Supply button
- 8 - Function button
- 9 - Remaining Time / Delay Start Time / Error Display

## Operating the product

### 5.2 Preparing the machine



Figures in this manual are schematic and may not match the product exactly.

#### • Power Button

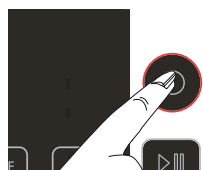

Press this button once to operate. Press it again to turn the power off.

#### • Start/Pause Button

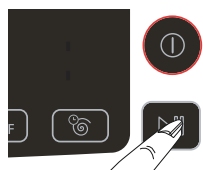

Use to pause and restart the operation. To change the washing procedure during an operation, press this button to stop, and again to restart after changing the procedure.

#### • Program Select Button

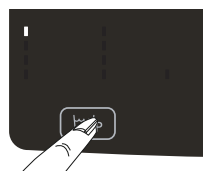

Each time the button is pressed, the washing program changes.

#### • Water Supply Button (OPTION)

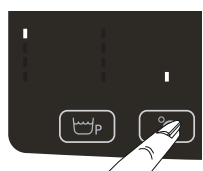

Each time this button is pressed, the type of water is selected as follows,  
Cold / Hot / Warm  
Cold: No light  
Warm: Red light  
Hot: Flashin red light

#### • Remaining Time, Delay Start Time, Error Display



Displays the remaining wash time. Displays the reserved delay start time. Displays the error state if a problem occurs in the washing machine so that you can take action.

#### • Delay Start Time Button

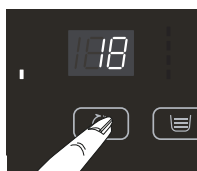

Adjusts delay start time. max. 18 h

#### • Water Level Button

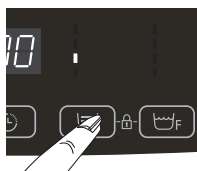

The water level is automatically adjusted. However, you can select the water level manually by pressing this button. The water level button only can be active during standby status, water level can be changed before start to running; and you can press the start/pause button then change water level while machine is running, press start/pause again back to work after finish water level setting. Displays selected program's default water level.  
Low /2/3/4/5/6/7/8

## Operating the product

### • Function Button

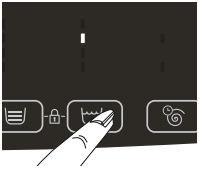

With every press of this button, the function changes.

### • Air Turbo Button

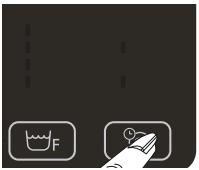

Press this button to speed dry your laundry. This function can only be selected if a spin cycle is set. The air Turbo button only can be active during standby status, this function can be changed before start to running; and you can press the start/pause button then change time while machine is running, press start/pause again back to work after finish water level setting.

### • Rinse Hold



Rinse hold will be selectable from 'air dry' function button. 2 LED's will be ON together during rinse hold selection. After the last rinse, water will not drain out. It will be kept in the machine. Machine pause at the step, and led1 and led2 always blink. When the customer wants to drain the water, they need press the pause start button again to continue spin with default time.

### • Child Lock



This is a device to protect children from being accidentally hurt while playing with the washer.

#### How to start the Child-Lock function:

- Press the "Water level" button and "Function" button at the same time for 3 sec.
- If Child Lock function is activated, "CL" will be written in the display for 3 sec.

To release the function of Child-Lock: In case the "Child-Lock" is programmed, press both the "Water level" and "Function" buttons at the same time.

## Operating the product

### 5.3 Main programmes

Depending on the type of fabric, use the following main programmes.



Figures in this manual are schematic and may not match the product exactly.

#### • Auto

This programme selects the best water level and wash course automatically depending on the amount of laundry. Use this programme for washing cotton and blended items.

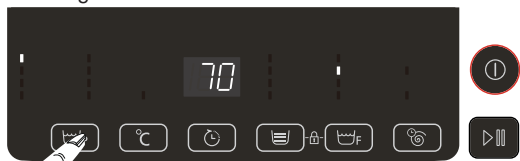

#### • Blanket

This programme is suitable for washing bulky laundry items such as blankets and bed sheets. Fold the bulky items in a suitable manner before placing in the wash basket. Loading recommendation: max 1/2 of the full capacity.

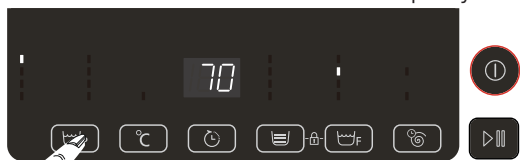

#### • Eco

This programme is suitable for washing less amount (e.g. max 1/3 of the full capacity) of lightly/daily soiled laundry in short time using minimum amount of water.

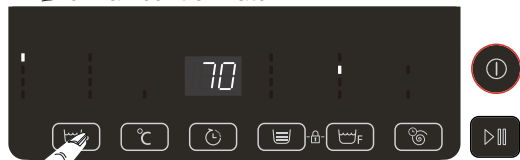

#### • Tub Clean

Use this programme on a regular basis (e.g. once in a month) to sanitize and clean your machine and to prevent unwanted odours. Do not place any items or laundry in the machine when you use this programme, it must be operated when the washer is empty otherwise laundry or washer might be damaged. You can add a special purpose detergent suitable for cleaning machines.

High water and 3 min air turbo options are set automatically in this wash course.

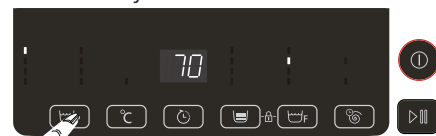

#### • Delicate

Use this programme for washing machine washable delicate (cotton, blended and wool) items such as sweaters, jumpers and cardigans. Hot water and soaking options can not be selected in this wash course. It is recommended to use special purpose detergents suitable for washing delicate laundry. Loading recommendation: max 1/3 of the full capacity.

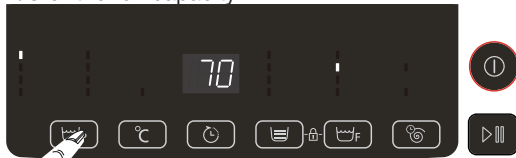

#### • Normal

This programme is suitable for washing up to a full capacity of normally soiled durable cotton and blended clothes.

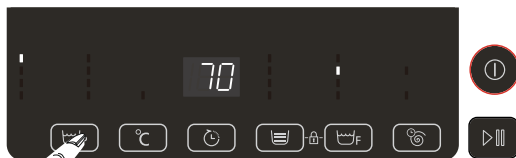

#### • Quick

This programme is suitable for washing up to a full capacity of lightly/daily soiled durable cotton and blended clothes.

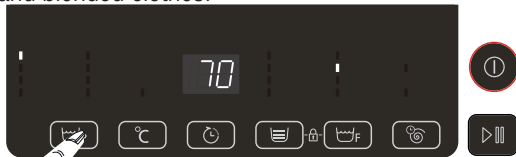

#### • Heavy

This programme is suitable for washing up to a full capacity of heavily soiled durable cotton and blended clothes. Soaking and hot water functions are set automatically in this wash course.



## Operating the product

### 5.4 Auxiliary function selection



Figures in this manual are schematic and may not match the product exactly.

#### • Wash

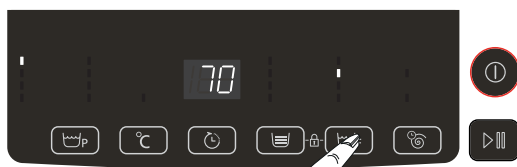

#### • Soaking

Select this function if you like to wash your laundry by soaking. Soaking is recommended for heavily soiled laundry items. You can add your normal amount of detergent and start the wash programme by selecting this function. Soaking is not selectable in Eco, Fuzzy, Tub clean and Wool programmes.



#### • Rinse

Use this programme when you want to rinse or starch separately.



#### • Spin

Use this programme to apply an additional spin cycle for your laundry or to drain the water in the machine.

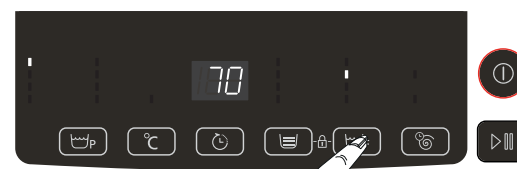





# Operating the product

## 5.5 Programme and consumption table

Program	Load(kg)	Water level	Functions						Air turbo		duration (min)
			S/W/R/S	W/R/S	Spin	R/S	W/R	Wash	15min	30min	
Blanket	4	8	•	•	•	•	•	•	•	•	70
Blanket		7	•	•	•	•	•	•	•	•	66
Blanket	3	6	•	•	•	•	•	•	•	•	62
Blanket		5	•	•	•	•	•	•	•	•	58
Blanket	2	4	•	•	•	•	•	•	•	•	55
Blanket		3	•	•	•	•	•	•	•	•	52
Blanket	1	2	•	•	•	•	•	•	•	•	48
Blanket	0.5	1	•	•	•	•	•	•	•	•	45
Eco	3	4		•	•	•	•	•	•	•	37
Eco	2	3		•	•	•	•	•	•	•	34
Eco	1	2		•	•	•	•	•	•	•	30
Eco	0.5	1		•	•	•	•	•	•	•	27
Auto	—	—		•			•	•	•	•	—
Heavy	max	8	•	•	•	•	•	•	•	•	101
Heavy	6	7	•	•	•	•	•	•	•	•	97
Heavy	5	6	•	•	•	•	•	•	•	•	93
Heavy	4	5	•	•	•	•	•	•	•	•	89
Heavy	3	4	•	•	•	•	•	•	•	•	86
Heavy	2	3	•	•	•	•	•	•	•	•	83
Heavy	1	2	•	•	•	•	•	•	•	•	79
Heavy	0.5	1	•	•	•	•	•	•	•	•	76
Normal	max	8	•	•	•	•	•	•	•	•	68
Normal	6	7	•	•	•	•	•	•	•	•	64
Normal	5	6	•	•	•	•	•	•	•	•	60
Normal	4	5	•	•	•	•	•	•	•	•	56
Normal	3	4	•	•	•	•	•	•	•	•	53
Normal	2	3	•	•	•	•	•	•	•	•	50
Normal	1	2	•	•	•	•	•	•	•	•	46
Normal	0.5	1	•	•	•	•	•	•	•	•	43
Tub clean	—	8		•					•	•	76
Delicate	4	8		•	•	•	•	•	•	•	50
Delicate		7		•	•	•	•	•	•	•	46
Delicate	3	6		•	•	•	•	•	•	•	42
Delicate		5		•	•	•	•	•	•	•	38
Delicate	2	4		•	•	•	•	•	•	•	35
Delicate		3		•	•	•	•	•	•	•	32
Delicate	1	2		•	•	•	•	•	•	•	28
Delicate	0.5	1		•	•	•	•	•	•	•	25
Quick	2	3		•							22

• : Selectable

\* : Automatically selected, no canceling.

	<b>Auxiliary functions</b> So:Soaking      W:Wash R:Rinse          Sp:Spin
	The auxiliary functions in the table may vary according to the model of your machine.
	Water and power consumption may vary subject to the changes in water pressure, water hardness and temperature, ambient temperature, type and amount of laundry, selection of auxiliary functions and spin speed, and changes in electric voltage.
	You can see the washing time of the programme you have selected on the display of the machine. It is normal that small differences may occur between the time shown on the display and the real washing time.

## 6 Maintenance and cleaning

Service life of the product extends and frequently faced problems decrease if cleaned at regular intervals.

### 6.1 Cleaning the detergent drawer

Clean the detergent drawer at regular intervals (every 4-5 washing cycles) as shown below in order to prevent accumulation of powder detergent in time.



1. Detergent drawer is closed.
  2. Pulling detergent drawer to the front side.
  3. Turning detergent drawer to upper side, and taking drawer out.
- Cleaning detergent drawer by water.

### 6.2 Cleaning the body and control panel

Wipe the body of the machine with soapy water or non-corrosive mild gel detergents as necessary, and dry with a soft cloth.

Use only a soft and damp cloth to clean the control panel.

### 6.3 Cleaning the water intake filters

There is a filter at the end of each water intake valve at the rear of the machine and also at the end of each water intake hose where they are connected to the tap. These filters prevent foreign substances and dirt in the water to enter the washing machine. Filters should be cleaned as they do get dirty.

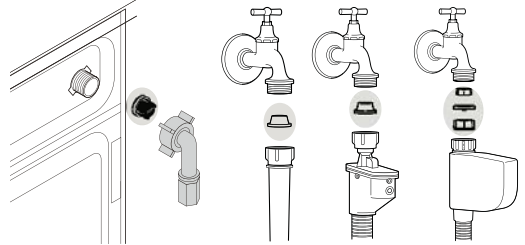

1. Close the taps.
2. Remove the nuts of the water intake hoses to access the filters on the water intake valves. Clean them with an appropriate brush. If the filters are too dirty, take them out by means of pliers and clean them.
3. Take out the filters on the flat ends of the water intake hoses together with the gaskets and clean thoroughly under running water.
4. Replace the gaskets and filters carefully in their places and tighten the hose nuts by hand.



## Maintenance and cleaning

### 6.4 Draining remaining water and cleaning the pump filter

The filter system in your machine prevents solid items such as buttons, coins and fabric fibers clogging the pump impeller during discharge of washing water. Thus, the water will be discharged without any problem and the service life of the pump will extend.

If the machine fails to drain water, the pump filter is clogged. Filter must be cleaned whenever it is clogged or in every 3 months. Water must be drained off first to clean the pump filter.

In addition, prior to transporting the machine (e.g., when moving to another house) and in case of freezing of the water, water may have to be drained completely.



**WARNING:** Foreign substances left in the pump filter may damage your machine or may cause noise problem.

#### In order to clean the dirty filter and discharge the water:

1. Unplug the machine to cut off the supply power.
2. Open the filter cap.  
Press the tab on the filter cap to the left side and pull the cover out towards yourself.

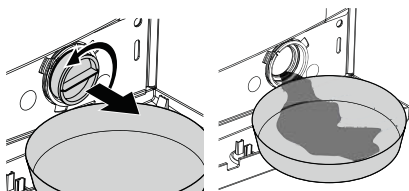

- a. Place a large container in front of the filter to catch water from the filter.

- b. Loosen pump filter (anticlockwise) until water starts to flow. Fill the flowing water into the container you have placed in front of the filter. Always keep a piece of cloth handy to absorb any spilled water.
- c. When the water inside the machine is finished, take out the filter completely by turning it.
4. Clean any residues inside the filter as well as fibers, if any, around the pump impeller region.
5. Install the filter.

### 6.4 Cleaning the fuzz collector

1. push to take the filter out.

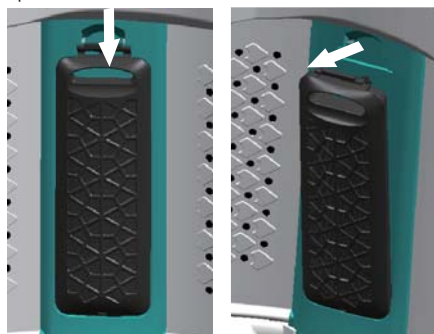

2. Open the filter and cleaning. Keep the filter rubber in the original position.



3. After cleaning assemble the filter on the right position.

## 7 Troubleshooting

Problem	Check & Solution
The power is cut off.	<ul style="list-style-type: none"> <li>- Is the electric voltage normal?</li> <li>- Is the washer plugged in? Plug in the electric cord.</li> </ul>
Water does not drain.	<ul style="list-style-type: none"> <li>- Is the drain hose down? Put the drain hose down.</li> <li>- Is the drain hose folded? Unfold the drain hose.</li> <li>- Is the drain hose outlet clogged? Remove the waste cleanly.</li> </ul>
Washing machine won't work.	<ul style="list-style-type: none"> <li>- Is the washer lid open? Close the lid.</li> <li>- Is the Pause button on? Press the Start/Pause button one more time and check if the washer starts.</li> <li>- Is enough water filled to the water level?</li> <li>- If the water pressure is low, it takes a long time to start washing.</li> <li>- Is the tap closed? Open the tap to supply water.</li> </ul>
If the drain hose, water tap and drum are frozen, do as follows.	<ul style="list-style-type: none"> <li>- Add hot water to the frozen water tap and remove the drain hose. Soak into hot water.</li> <li>- Pour hot water into the drum for about 10 minutes.</li> <li>- Put a hot water towel on the drain hose connector.</li> <li>- If the drain hose defrosts, connect again and check for proper water draining.</li> </ul>
The water does not drain out immediately.	<ul style="list-style-type: none"> <li>- The drain is clogged with coins or pins. The drain hose is hung over the drain hose hook.</li> <li>- Half fill the drum with water and try for spinning again.</li> </ul>
The water leaks at the water supply hose connector.	<ul style="list-style-type: none"> <li>- If the connecting part is loose, water may leak. Repeat the assembling steps again. (Refer to "Connection of inlet hose connector and tap" and "Connecting to the water supply")</li> <li>- Is the water supply hose folded? Unfold the hose.</li> <li>- If the water supply is too strong, water may leak. Close the tap a little.</li> <li>- Is water leaking from the tap itself? Fix the tap.</li> </ul>
Water is not supplied	<ul style="list-style-type: none"> <li>- Did you press the Start/Pause button after selecting the water supply?</li> <li>- If the Start/Pause button is not pressed, water is not supplied. Press the Start/Pause - button.</li> <li>- Is the tap closed? Turn on the tap.</li> <li>- Is the filter net at the water supply hose connector clogged with dirty matters? Clean the filter net by brushing with a toothbrush.</li> <li>- Is the water supply cut off? If the water supply is suspended, turn off the tap and power off.</li> </ul>
Spinning makes loud noises and vibrations.	<ul style="list-style-type: none"> <li>- Check if the laundry is spread evenly in the washer. Spread out the laundry evenly and start again.</li> <li>- Check if the washing machine levels on a sturdy flat floor. Set the machine at level. Adjust the feet for leveling.</li> <li>- Is around the washing machine filled with unnecessary stuffs? Remove those unnecessary things away from the wash machine.</li> </ul>



**WARNING:** If you cannot eliminate the problem although you follow the instructions in this section, consult your dealer or the Authorized Service Agent. Never try to repair a nonfunctional product yourself.

## Troubleshooting

Error Message	Error	Control
<b>E1</b>	<b>Water intake over time</b>	<ul style="list-style-type: none"> <li>- Is the water tap shut off?</li> <li>- Is the water supply cut off ?</li> <li>- Is the water supply hose punctured ?</li> <li>- Is the tap or water supply hose frozen ?</li> <li>- Is the water pressure low or is the filter of the inlet valve clogged with impurities?</li> <li>- Is the Hot hose connected to cold?</li> <li>- Is the Cold hose connected to hot?</li> </ul>
<b>E2</b>	<b>Water pumping over time</b>	<ul style="list-style-type: none"> <li>- Is the drain hose positioned correctly?</li> <li>- Is the drain hose bent or placed too high?</li> <li>- Is the internal part of the hose or drain pump (only pump model) clogged with impurities?</li> </ul>
<b>E3</b>	<b>Unbalance</b>	<ul style="list-style-type: none"> <li>- Is the laundry evenly balanced?</li> <li>- Is the washing machine placed on a flat surface?</li> </ul>
<b>E4</b>	<b>Over flow</b>	<ul style="list-style-type: none"> <li>- Please call your nearest service center for help.</li> </ul>
<b>E5</b>	<b>Frequency out of range</b>	<ul style="list-style-type: none"> <li>- Please call your nearest service center for help.</li> </ul>
<b>E6</b>	<b>Door open</b>	<ul style="list-style-type: none"> <li>- Is the lid closed?</li> </ul>



**WARNING:** If you cannot eliminate the problem although you follow the instructions in this section, consult your dealer or the Authorized Service Agent. Never try to repair a nonfunctional product yourself.

