

# Built-in Hob

User manual



HIZG 64120 SX

**EN**

185.9101.59/R.AC/01.08.2016/3-1

## Please read this user manual first!

Dear Customer,

Thank you for purchasing this Beko product. We hope that you get the best results from your product which has been manufactured with high quality and state-of-the-art technology. Therefore, please read this entire user manual and all other accompanying documents carefully before using the product and keep it as a reference for future use. If you handover the product to someone else, give the user manual as well. Follow all warnings and information in the user manual.

Remember that this user manual is also applicable for several other models. Differences between models will be identified in the manual.

### Explanation of symbols

Throughout this user manual the following symbols are used:

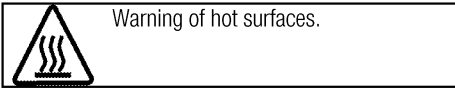
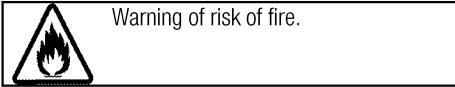
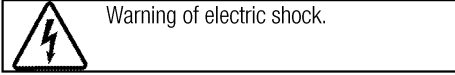
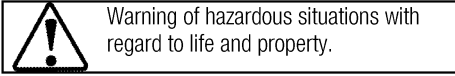
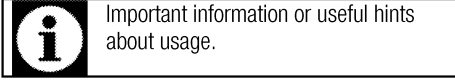

**Arçelik A.Ş.**  
Karaağaç caddesi No:2-6  
34445 Sütlüce/İstanbul/TURKEY  
Made in TURKEY



This product was manufactured using the latest technology in environmentally friendly conditions.

**1 Important instructions and warnings  
for safety and environment 4**

General safety.....4  
 Safety when working with gas.....4  
 Electrical safety.....5  
 Product safety.....6  
 Intended use.....7  
 Safety for children .....7  
 Disposing of the old product .....7  
 Package information.....8  
 Future Transportation .....8

**2 General information 9**

Overview .....9  
 Package contents.....10  
 Technical specifications.....10  
 Injector table.....10

**3 Installation 11**

Before installation .....11  
 Installation and connection.....12

**4 Preparation 15**

Tips for saving energy ..... 15  
 Initial use ..... 15  
 First cleaning of the appliance..... 15

**5 How to use the hob 16**

General information about cooking ..... 16  
 Using the hobs..... 16

**6 Maintenance and care 18**

General information ..... 18  
 Cleaning the hob ..... 18  
 Cleaning the control panel ..... 18

**7 Troubleshooting 19**

## **I Important instructions and warnings for safety and environment**

This section contains safety instructions that will help protect from risk of personal injury or property damage. Failure to follow these instructions shall void any warranty.

### **General safety**

- This appliance can be used by children aged from 8 years and above and persons with reduced physical, sensory or mental capabilities or lack of experience and knowledge if they have been given supervision or instruction concerning use of the appliance in a safe way and understand the hazards involved.

Children shall not play with the appliance. Cleaning and user maintenance shall not be made by children without supervision.

- Installation and repair procedures must always be performed by Authorized Service Agents. The manufacturer shall not be held responsible for damages arising from procedures carried out by unauthorized persons which may also void the warranty. Before installation, read the instructions carefully.
- Do not operate the product if it is defective or has any visible damage.

- Ensure that the product function knobs are switched off after every use.

### **Safety when working with gas**

- Any works on gas equipment and systems may only be carried out by authorised qualified persons who are Gas Safe registered.
- Prior to the installation, ensure that the local distribution conditions (nature of the gas and gas pressure) and the adjustment of the appliance are compatible.
- This appliance is not connected to a combustion products or evacuation device. It shall be installed and connected in accordance with current installation regulations. Particular attention shall be given to the relevant requirements regarding ventilation; See *Before installation, page 11*
- The use of gas cooking appliance results in the production of heat and moisture in the room in which it is installed. Ensure that the kitchen is well ventilated: keep natural ventilation holes open or install a mechanical ventilation device (mechanical extractor hood). Prolonged intensive use of the appliance may call for

additional ventilation, for example increasing the level of the mechanical ventilation where present.

- Gas appliances and systems must be regularly checked for proper functioning. Regulator, hose and its clamp must be checked regularly and replaced within the periods recommended by its manufacturer or when necessary.
- Clean the gas burners regularly. The flames should be blue and burn evenly.
- Good combustion is required in gas appliances. In case of incomplete combustion, carbon monoxide (CO) might develop. Carbon monoxide is a colourless, odourless and very toxic gas, which has a lethal effect even in very small doses.
- Request information about gas emergency telephone numbers and safety measures in case of gas smell from you local gas provider.

### **What to do when you smell gas**

- Do not use open flame or do not smoke. Do not operate any electrical buttons (e.g. lamp button, door bell and etc.) Do not use fixed or mobile phones. Risk of explosion and toxication!
- Open doors and windows.

- Turn off all valves on gas appliances and gas meter at the main control valve, unless it's in a confined space or cellar.
- Check all tubes and connections for tightness. If you still smell gas leave the property.
- Warn the neighbours.
- Call the fire-brigade. Use a telephone outside the house.
- Do not re-enter the property until you are told it is safe to do so.

### **Electrical safety**

- If the product has a failure, it should not be operated unless it is repaired by an Authorized Service Agent. There is the risk of electric shock!
- Only connect the product to a grounded outlet/line with the voltage and protection as specified in the "Technical specifications". Have the grounding installation made by a qualified electrician while using the product with or without a transformer. Our company shall not be liable for any problems arising due to the product not being earthed in accordance with the local regulations.
- Never wash the product by spreading or pouring water onto it! There is the risk of electric shock!
- Never touch the plug with wet hands! Never unplug by pulling on

the cable, always pull out by grabbing the plug.

- The product must be disconnected during installation, maintenance, cleaning and repairing procedures.
- If the power connection cable for the product is damaged, it must be replaced by the manufacturer, its service agent or similarly qualified persons in order to avoid a hazard.
- The appliance must be installed so that it can be completely disconnected from the mains supply. The separation must be provided by a switch built into the fixed electrical installation, according to construction regulations.
- Any work on electrical equipment and systems should only be carried out by authorized and qualified persons.
- In case of any damage, switch off the product and disconnect it from the mains. To do this, turn off the fuse at home.
- Make sure that fuse rating is compatible with the product.

### **Product safety**

- The appliance and its accessible parts become hot during use. Care should be taken to avoid touching heating elements. Children less than 8 years of age

shall be kept away unless continuously supervised.

- Never use the product when your judgment or coordination is impaired by the use of alcohol and/or drugs.
- Be careful when using alcoholic drinks in your dishes. Alcohol evaporates at high temperatures and may cause fire since it can ignite when it comes into contact with hot surfaces.
- Do not place any flammable materials close to the product as the sides may become hot during use.
- Keep all ventilation slots clear of obstructions.
- Do not use steam cleaners to clean the appliance as this may cause an electric shock.
- Unattended cooking on a hob with fat or oil can be dangerous and may result in fire. NEVER try to extinguish a fire with water, but switch off the appliance and then cover flame e.g. with a lid or a fire blanket.
- Danger of fire: Do not store items on the cooking surfaces.

Prevention against possible fire risk!

- Ensure all electrical connections are secure and tight to prevent risk of arcing.
- Do not use damaged cables or extension cables.

- Ensure liquid or moisture is not accessible to the electrical connection point.
- To prevent gas leakage ensure that the gas connection is sound.

### **Intended use**

- This product is designed for domestic use. Commercial use will void the guarantee.
- This appliance is for cooking purposes only. It must not be used for other purposes, for example room heating.
- The manufacturer shall not be liable for any damage caused by improper use or handling errors.

### **Safety for children**

- Accessible parts may become hot during use. Young children should be kept away.
- The packaging materials will be dangerous for children. Keep the packaging materials away from children. Please dispose of all parts of the packaging according to environmental standards.
- Electrical and/or gas products are dangerous to children. Keep children away from the product when it is operating and do not allow them to play with the product.
- Do not place any items above the appliance that children may reach for.

### **Disposing of the old product Compliance with the WEEE Directive and Disposing of the Waste Product:**



This product complies with EU WEEE Directive (2012/19/EU). This product bears a classification symbol for waste electrical and electronic equipment (WEEE).

This product has been manufactured with high quality parts and materials which can be reused and are suitable for recycling. Do not dispose of the waste product with normal domestic and other wastes at the end of its service life. Take it to the collection center for the recycling of electrical and electronic equipment. Please consult your local authorities to learn about these collection centers.

### **Compliance with RoHS Directive:**

The product you have purchased complies with EU RoHS Directive (2011/65/EU). It does not contain harmful and prohibited materials specified in the Directive.

## Package information

- Packaging materials of the product are manufactured from recyclable materials in accordance with our National Environment Regulations. Do not dispose of the packaging materials together with the domestic or other wastes. Take them to the packaging material collection points designated by the local authorities.

## Future Transportation

- Keep the product's original carton and transport the product in it. Follow the instructions on the carton. If you do not have the original carton, pack the product in bubble wrap or thick cardboard and tape it securely.
- Secure the caps and pan supports with adhesive tape.



Check the general appearance of your product for any damages that might have occurred during transportation.



## 2 General information

### Overview

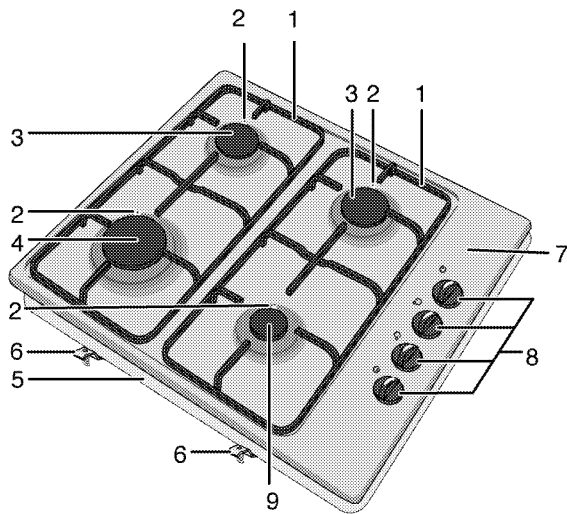

- |   |               |   |                  |
|---|---------------|---|------------------|
| 1 | Pan support   | 6 | Assembly clamp   |
| 2 | Spark plug    | 7 | Burner plate     |
| 3 | Normal burner | 8 | Gas burners knob |
| 4 | Rapid burner  | 9 | Auxiliary burner |
| 5 | Base cover    |   |                  |

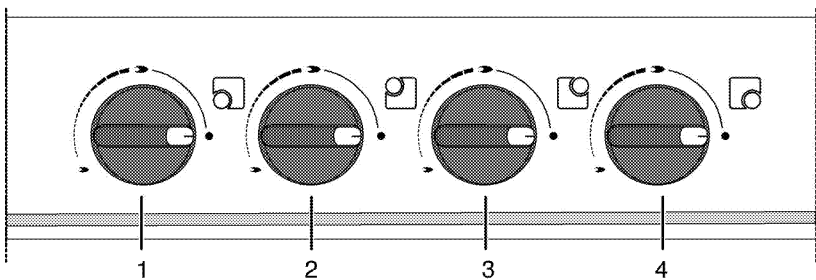

- |   |                              |   |                          |
|---|------------------------------|---|--------------------------|
| 1 | Auxiliary burner Front right | 3 | Normal burner Rear left  |
| 2 | Rapid burner Front left      | 4 | Normal burner Rear right |

## Package contents

**i** Accessories supplied can vary depending on the product model. Not every accessory described in the user manual may exist on your product.

1. User manual

## Technical specifications

Voltage / frequency	220-240 V ~ 50 Hz
Cable type / section	H05RR-F 3 x 1,5 mm <sup>2</sup>
Cable length	max. 2 m
Gas type / pressure	LPG G 30/28-30 mbar
Total gas consumption	7.9 kW
External dimensions (height / width / depth)	84 mm/580 mm/510 mm
Installation dimensions (width / depth)	560 mm/490 mm
<b>Burners</b>	
Front right	<b>Auxiliary burner</b>
Power	1000 W
Front left	<b>Rapid burner</b>
Power	2900 W
Rear left	<b>Normal burner</b>
Power	2000 W
Rear right	<b>Normal burner</b>
Power	2000 W

**i** Technical specifications may be changed without prior notice to improve the quality of the product.

**i** Figures in this manual are schematic and may not exactly match your product.

2. Coffee pot adaptor



Used for coffe pots.

**i** Values stated on the product labels or in the documentation accompanying it are obtained in laboratory conditions in accordance with relevant standards. Depending on operational and environmental conditions of the product, these values may vary.

## Injector table

Position hob zone	1000 W Front right	2900 W Front left	2000 W Rear left	2000 W Rear right
Gas type / Gas pressure				
G 30/28-30 mbar	50	87	72	72

### 3 Installation

Product must be installed by a qualified person in accordance with the regulations in force. The manufacturer shall not be held responsible for damages arising from procedures carried out by unauthorized persons which may also void the warranty.

 Preparation of location and electrical and gas installation for the product is under customer's responsibility.

 **DANGER:**  
The product must be installed in accordance with all local gas and/or electrical regulations.

 **DANGER:**  
Prior to installation, visually check if the product has any defects on it. If so, do not have it installed.  
Damaged products cause risks for your safety.

#### Before installation

The hob is designed for installation into commercially available work tops. A safety distance must be left between the appliance and the kitchen walls and furniture. See figure (values in mm).

- It can also be used in a free standing position. Allow a minimum distance of 750 mm above the hob surface.
- (\*) If a cooker hood is to be installed above the cooker, refer to cooker hood manufacturer' instructions regarding installation height (min 650 mm)
- Remove packaging materials and transport locks.
- Surfaces, synthetic laminates and adhesives used must be heat resistant (100 °C minimum).
- The worktop must be aligned and fixed horizontally.
- Cut aperture for the hob in worktop as per installation dimensions.

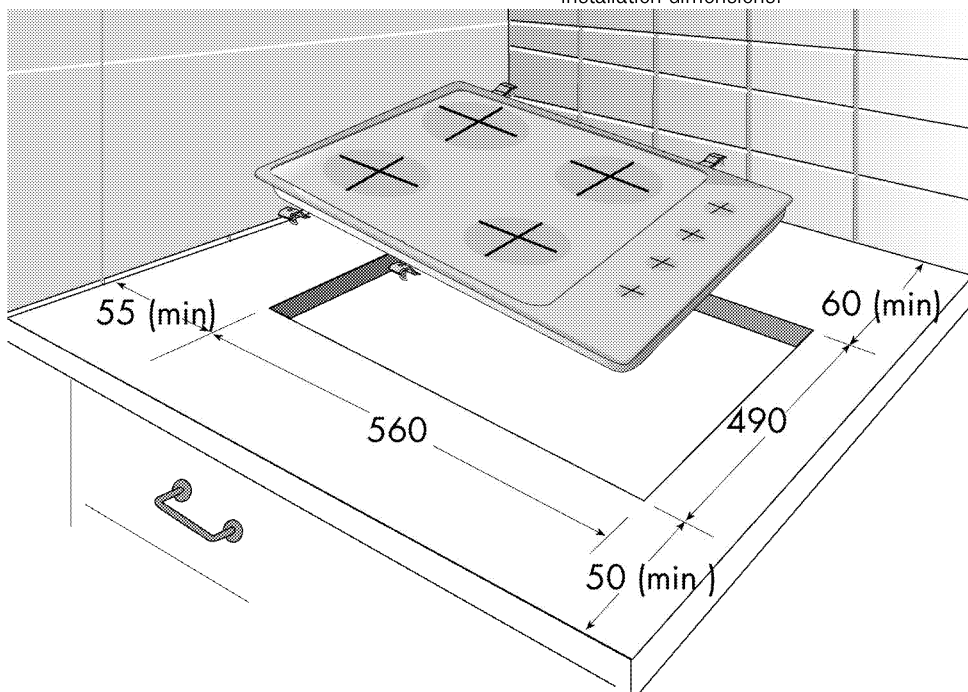

## Room ventilation

All rooms require an openable window, or equivalent, and some rooms will require a permanent vent as well.

The air for combustion is taken from the room air and the exhaust gases are emitted directly into the room.

Good room ventilation is essential for safe operation of your appliance. If there is no window or door available for room ventilation, an extra ventilation must be installed.

The appliance may be located in a kitchen, kitchen/diner or a bed-sitting room, but not in a room containing a bath or shower. The appliance must not be installed in a bed-sitting room of less than 20m<sup>3</sup>.

Do not install this appliance in a room below ground level unless it is open to ground level on at least one side.

Room size	Ventilation opening
smaller than 5 m <sup>3</sup>	min. 100 cm <sup>2</sup>
5 m <sup>3</sup> to 10 m <sup>3</sup>	min. 50 cm <sup>2</sup>
greater than 10 m <sup>3</sup>	not required
In the cellar or basement	min. 65 cm <sup>2</sup>

## Installation and connection

- Product can only be installed and connected in accordance with the statutory installation rules.

### Electrical connection

Connect the product to a grounded outlet/line protected by a fuse of suitable capacity as stated in the "Technical specifications" table. Have the grounding installation made by a qualified electrician while using the product with or without a transformer. Our company shall not be liable for any damages that will arise due to using the product without a grounding installation in accordance with the local regulations.



**DANGER:** The product must be connected to the mains supply only by an authorised and qualified person. The product's warranty period starts only after correct installation. Manufacturer shall not be held responsible for damages arising from procedures carried out by unauthorised persons.



**DANGER:** The power cable must not be clamped, bent or trapped or come into contact with hot parts of the product.  
A damaged power cable must be replaced by a qualified electrician. Otherwise, there is risk of electric shock, short circuit or fire!

- Connection must comply with national regulations.
- The mains supply data must correspond to the data specified on the type label of the product. Type label is at the rear housing of the product.
- Power cable of your product must comply with the values in "Technical specifications" table.



**DANGER:** Before starting any work on the electrical installation, disconnect the product from the mains supply.  
There is the risk of electric shock!



Power cable plug must be within easy reach after installation (do not route it above the hob).

Plug the power cable into the socket.

### Gas connection



**DANGER:** Product can be connected to gas supply system only by an authorised and qualified person or technician with licence.  
Risk of explosion or toxication due to unprofessional repairs!  
Manufacturer shall not be held responsible for damages arising from procedures carried out by unauthorised or unlicensed persons.



**DANGER:** Before starting any work on the gas installation, disconnect the gas supply.  
There is the risk of explosion!

- Gas adjustment conditions and values are stated on labels (or ion type label).



Your product is equipped for liquefied petroleum gas (LPG).

## Connecting the gas hose

- Have your product connected in a way that it will be close to the gas connection and not gas leakage will exist.
- Plastic hose to be used must not be longer than 125 cm.
- Install the clamp to the hose. Soak one end of the hose (15 mm inner diameter) into boiling water for one minute to soften it.
- Then, slip the softened end of the hose completely onto the sharp hose tip of your product. Finally, tighten the clamp completely with a screwdriver.
- Repeat the same procedure for the other end of the hose and complete the gas cylinder connection.
- Never forget to make the gas leakage control.



### DANGER:

Risk of explosion and suffocation!  
Do not keep LPG cylinders in home.

- If you need to use your product later with a different type of gas, you must consult the Authorised Service Agent for the related conversion procedure.

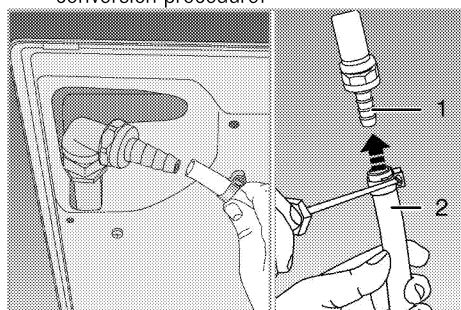

- 1 LPG hose tip
- 2 Plastic hose

## Leakage control at the connection point

- Make sure that all knobs on the product are turned off. Make sure that the gas supply is open. Prepare soapy foam and apply it onto the connection point of the hose for gas leakage control.
- Soapy part will froth if there is a gas leakage. In this case, inspect the gas connection once again.



Never use a match or lighter to make the gas leakage control.

## Installing the product

1. Remove burners, burner caps and grills on the hob from the product.  
Turning the hob upside down, place it on a flat surface.
2. In order to avoid the foreign substances and liquids penetrate between the hob and the counter, please apply the putty supplied in the package on the contours of the lower housing of the hob but make sure that the putty does not overlap.

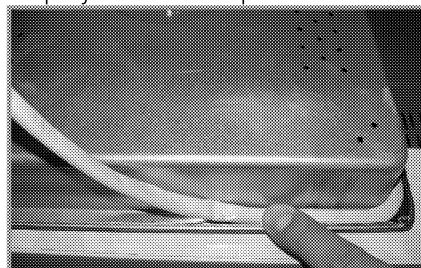

3. Turning the hob again, align and place it on the counter.
4. You can secure your hob to the counter by using the clamp and the screws supplied.

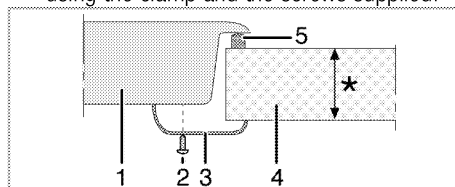

\* min. 20 & max. 40 mm

- 1 Hob
- 2 Screw
- 3 Installation clamp
- 4 Counter

5 Putty

### Rear view (connection holes)

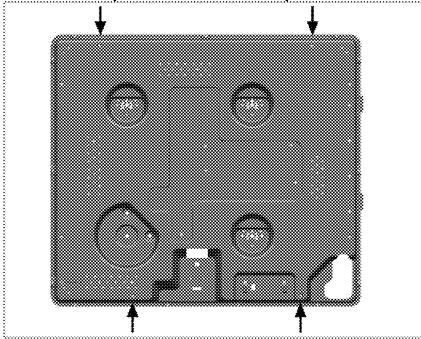

Place the burner plates, burner plate caps and grills back to their seating after installation.

**i** Making connections to different holes is not a good practice in terms of safety since it can damage the gas and electrical system.

### Final check

1. Open gas supply.
2. Check gas installations for secure fitting and tightness.

3. Ignite burners and check appearance of the flame.

**i** Flame must be blue and have a regular shape. If the flame is yellowish, check if the burner cap is seated securely or clean the burner.

## 4 Preparation

### Tips for saving energy

The following information will help you to use your appliance in an ecological way, and to save energy:

- Defrost frozen dishes before cooking them.
- Use pots/pans with cover for cooking. If there is no cover, energy consumption may increase 4 times.
- Select the burner which is suitable for the bottom size of the pot to be used. Always select the correct pot size for your dishes. Larger pots require more energy.

### Initial use

#### First cleaning of the appliance

	<p>The surface might get damaged by some detergents or cleaning materials. Do not use aggressive detergents, cleaning powders/creams or any sharp objects during cleaning. Do not use harsh abrasive cleaners or sharp metal scrapers to clean the oven door glass since they can scratch the surface, which may result in shattering of the glass.</p>
---	---

1. Remove all packaging materials.
2. Wipe the surfaces of the appliance with a damp cloth or sponge and dry with a cloth.

## 5 How to use the hob

### General information about cooking



Never fill the pan with oil more than one third of it. Do not leave the hob unattended when heating oil. Overheated oils bring risk of fire. **Never attempt to extinguish a possible fire with water!** When oil catches fire, cover it with a fire blanket or damp cloth. Turn off the hob if it is safe to do so and call the fire department.

- Before frying foods, always dry them well and gently place into the hot oil. Ensure complete thawing of frozen foods before frying.
- Do not cover the vessel you use when heating oil.
- Place the pans and saucepans in a manner so that their handles are not over the hob to prevent heating of the handles. Do not place unbalanced and easily tilting vessels on the hob.
- Do not place empty vessels and saucepans on cooking zones that are switched on. They might get damaged.
- Operating a cooking zone without a vessel or saucepan on it will cause damage to the product. Turn off the cooking zones after the cooking is complete.
- As the surface of the product can be hot, do not put plastic and aluminum vessels on it. Such vessels should not be used to keep foods either.
- Use flat bottomed saucepans or vessels only.
- Put appropriate amount of food in saucepans and pans. Thus, you will not have to make any unnecessary cleaning by preventing the dishes from overflowing. Do not put covers of saucepans or pans on cooking zones.

Place the saucepans in a manner so that they are centered on the cooking zone. When you want to move the saucepan onto another cooking zone, lift and place it onto the cooking zone you want instead of sliding it.

### Gas cooking

- Size of the vessel and the flame must match each other. Adjust the gas flames so that they will not extend the bottom of the vessel and center the vessel on saucepan carrier.

### Using the hobs

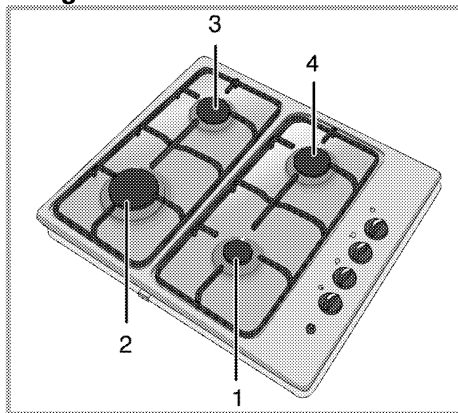

- 1 Auxiliary burner 12-18 cm
- 2 Rapid burner 22-24 cm
- 3 Normal burner 18-20 cm
- 4 Normal burner 18-20 cm is list of advised diameter of pots to be used on related burners.

Large flame symbol indicates the highest cooking power and small flame symbol indicates the lowest cooking power. In turned off position (top), gas is not supplied to the burners.

### Igniting the gas burners

1. Keep burner knob pressed.
  2. Turn it counter clockwise to large flame symbol.
- » Gas is ignited with the spark created.
3. Adjust it to the desired cooking power.

### Turning off the gas burners

Turn the knob to off (upper) position.



## Gas shut off safety system (in models with thermic component)

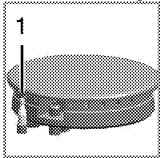

As a counter measure against blow out due to fluid overflows at burners, safety mechanism trips and shuts off the gas.

### 1. Gas shut off safety

- Push the knob inwards and turn it counter clockwise to ignite.
- After the gas ignites, keep the knob pressed for 3-5 seconds more to engage the safety system.
- If the gas does not ignite after you press and release the knob, repeat the same procedure by keeping the knob pressed for 15 seconds.



### **DANGER:**

Release the button if the burner is not ignited within 15 seconds.  
Wait at least 1 minute before trying again.  
There is the risk of gas accumulation and explosion!

## 6 Maintenance and care

### General information

Service life of the product will extend and the possibility of problems will decrease if the product is cleaned at regular intervals.

**DANGER:**

Disconnect the product from mains supply before starting maintenance and cleaning works.

There is the risk of electric shock!

**DANGER:**

Allow the product to cool down before you clean it.

Hot surfaces may cause burns!

- Clean the product thoroughly after each use. In this way it will be possible to remove cooking residues more easily, thus avoiding these from burning the next time the appliance is used.
- No special cleaning agents are required for cleaning the product. Use warm water with washing liquid, a soft cloth or sponge to clean the product and wipe it with a dry cloth.
- Always ensure any excess liquid is thoroughly wiped off after cleaning and any spillage is immediately wiped dry.
- Do not use cleaning agents that contain acid or chloride to clean the stainless or inox surfaces and the handle. Use a soft cloth with a liquid detergent (not abrasive) to wipe those parts clean, paying attention to sweep in one direction.



The surface might get damaged by some detergents or cleaning materials.

Do not use aggressive detergents, cleaning powders/creams or any sharp objects during cleaning.

Do not use harsh abrasive cleaners or sharp metal scrapers to clean the oven door glass since they can scratch the surface, which may result in shattering of the glass.



Do not use steam cleaners to clean the appliance as this may cause an electric shock.

### Cleaning the hob

#### Gas hobs

1. Remove and clean the saucepan carriers and burner caps.
2. Clean the hob.
3. Install the burner caps and make sure that they are seated correctly.
4. When installing the upper grills, pay attention to place the saucepan carriers so that the burners are centered.

### Cleaning the control panel

Clean the control panel and knobs with a damp cloth and wipe them dry.



Do not remove the control buttons/knobs to clean the control panel.

Control panel may get damaged!

## 7 Troubleshooting

### **Product emits metal noises while heating and cooling.**

- When the metal parts are heated, they may expand and cause noise. >>> *This is not a fault.*

### **There is no ignition spark.**

- No current. >>> *Check fuses in the fuse box.*

### **There is no gas.**

- Main gas valve is closed. >>> *Open gas valve.*
- Gas pipe is bent. >>> *Install gas pipe properly.*

### **Burners are not burning properly or at all.**

- Burners are dirty. >>> *Clean burner components.*
- Burners are wet. >>> *Dry the burner components.*
- Burner cap is not mounted safely. >>> *Mount the burner cap properly.*
- Gas valve is closed. >>> *Open gas valve.*
- Gas cylinder is empty (when using LPG). >>> *Replace gas cylinder.*



Consult the Authorised Service Agent or technician with licence or the dealer where you have purchased the product if you can not remedy the trouble although you have implemented the instructions in this section. Never attempt to repair a defective product yourself.

