

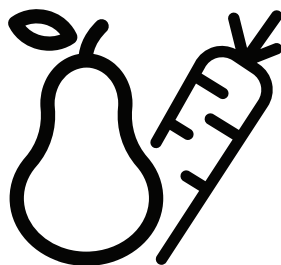

Refrigerator

User manual



B5RCNE365LXB - B5RCNE405LXB - B5RCNE405LXBR
B5RCNE405LXP - B5RCNE406LXBRW - B5RCNE366LXBW
B5RCNE366HXB - B5RCNE365HXB - B5RCNE365LXP



EN /

58 6317 0000/AD

**Dear Customer,
Please read this manual before using the product.**

Thank you for choosing this product. We would like you to achieve the optimal efficiency from this high quality product which has been manufactured with state of the art technology. To do this, carefully read this manual and any other documentation provided before using the product and keep it as a reference. Heed all information and warnings in the user manual. This way, you will protect yourself and your product against the dangers that may occur. Keep the user manual. Include this guide with the unit if you hand it over to someone else.



The following symbols are used in the user guide:

 Hazard that may result in death or injury.









NOTICE A hazard that may cause material damage to the product or its surroundings

 Important information or useful tips on operation.

 Read the user manual.

 INFORMATION	
 SUPPLIER'S NAME A	 MODEL IDENTIFIER (*) A
The model information as stored in the product data base can be reached by entering following website and searching for your model identifier (*) found on energy label. https://eprel.ec.europa.eu/	

1 Safety Instructions **4**

-  1.1 Purpose of usage 4
-  1.2 Safety of children, vulnerable persons and pets 4
-  1.3 Electrical safety 5
-  1.4 Handling Safety 5
-  1.5 Installation Safety 5
-  1.6 Operational safety 6
-  1.7 Maintenance and cleaning safety 8
-  1.8 HomeWhiz 8
-  1.9 Lighting 8

2 Environmental instructions **9**

3 Your Refrigerator **10**

4 Installation **11**

- 4.1.Appropriate Installation Location .11
- 4.2.Adjusting the Feet 12
- 4.3.Electrical Connection 12
- 4.4.Attaching the plastic wedges 12

5 Preparation **13**

6 Operating the product **14**

- 6.1.Changing the illumination lamp ... 16
- 6.2.Changing the door opening direction 16
- 6.3.Open door warning 16
- 6.4.The dairy (cold storage) bin 16
- 6.5.Deodoriser Module..... 17
- 6.6. Blue light/HarvestFresh 18
- 6.7.Moisture controlled vegetable bin 18
- 6.8.Freezing fresh food 19
- 6.9.Recommendations for storing frozen foods..... 20
- 6.10.Deep freezer details..... 20
- 6.11.Placing the food 21

7 Maintenance and cleaning **22**

8 Troubleshooting **23**

1 Safety Instructions

- This section includes the safety instructions necessary to prevent the risk of personal injury or material damage.
- Our company shall not be held responsible for damages that may occur if these instructions are not observed.

 Installation and repair operations shall always be performed by Authorized Service.

 Always use genuine spare parts and accessories.

 Original spare parts will be provided for 10 years, following the product purchasing date.

 Do not repair or replace any part of the product unless specified expressly in the user manual.

 Do not perform any modifications on the product.

1.1 Purpose of usage

- This product is not intended for commercial use and it shall not be used out of its intended purpose. This product is intended for operating interiors, such as households or similar. For example;
 - In the staff kitchens of the stores, offices and other working environments,
 - In farm houses,
 - In the units of hotels, motels or other resting facilities that are used by the customers,
 - In hostels, or similar environments,
 - In catering services and similar non-retail applications.

This product shall not be used in open or enclosed external environments such as vessels, balconies or terraces. Exposing the product to rain, snow, sunlight and wind may cause risk of fire.

1.2 Safety of children, vulnerable persons and pets

- This product may be used by children aged 8 years and older and persons with underdeveloped physical, sensory or mental capabilities or lack of experience and knowledge if they have been given supervision or instruction concerning use of the appliance in a the product safe way and the hazards involved.
- Children between 3 and 8 years are allowed to put and take out food to/from the cooler product.
- Electrical products are dangerous for children and pets. Children and pets must not play with, climb on, or enter the product.
- Cleaning and user maintenance should not be performed by children unless there is someone overseeing them.
- Keep the packaging materials away from children. Risk of injury and suffocation.
- Before disposing of old products that shall not be used any more:
 1. Unplug the power cord from the mains socket.
 2. Cut the power cord and remove it from the appliance together with the plug.
 3. Do not remove the racks and drawers from the product to prevent children from getting inside the appliance.
 4. Remove the doors.
 5. Store the product so that it shall not be tipped over.
 6. Do not allow children to play with the scrapped product.
- Do not dispose of the product by throwing it into fire. Risk of explosion.

Safety instructions

- If there is a lock available in the product's door, keep the key out of children's reach.

1.3 Electrical safety

- The product shall not be plugged into the outlet during installation, maintenance, cleaning, repair, and transportation operations.
- If the power the cord is damaged, it shall be replaced by authorized service only to avoid any risk that may occur.
- Do not tuck the power cord under the product or to the rear of the product. Do not put heavy items on the power cord. The power cord should not be bent, crushed, and come into contact with any heat source.
- Do not use an extension cord, multi-plug or adaptor to operate your product.
- Portable multi sockets or portable power supplies may overheat and cause fire. Thus, do not have a multi-plug behind or in the vicinity of the product.
- The plug shall be easily accessible. If this is not possible, a mechanism that meets the electrical legislation and that disconnects all terminals from the mains (fuse, switch, main switch, etc.) shall be available on the electrical installation.
- Do not touch the plug with wet hands.
- When unplugging the appliance, don't hold the power cord, but the plug.

1.4 Handling Safety

- This product is heavy, do not handle it by yourself.
- Do not hold the product from its door while handling the product.
- Be careful not to damage the cooling system and the pipes while handling the product. Do not operate the product if the pipes are damaged, and contact an authorized service.

1.5 Installation Safety

- Contact the Authorized Service for the product's installation. To prepare the product for installation, see the information in the user guide and make sure the electric and water utilities are as required. If the installation is not suitable, call a qualified electrician and plumber to have them make the necessary arrangements. Otherwise, electric shock, fire, issues with the product or injuries may occur.
- Check for any damage on the product before installing it. Do not have the product installed if it is damaged.
- Place the product on a level and hard surface and balance with the adjustable legs. Otherwise, the refrigerator may tip over and cause injuries.
- The product shall be installed in a dry and ventilated environment. Do not keep carpets, rugs or similar floor covers under the product. This may cause risk of fire as a result of inadequate ventilation!
- Do not block or cover ventilation holes. Otherwise, power consumption may be increased and damage to your product may occur.

Safety instructions

- Do not connect the product to supply systems such as solar power supplies. Otherwise, damage to your product may occur as a result of the abrupt voltage fluctuations!
- The more refrigerant a refrigerator contains, the bigger its installation room shall be. In very small rooms, a flammable gas-air mixture may occur in case of a gas leak in the cooling system. At least 1 m³ of volume is required for each 8 grams of refrigerant. The amount of the refrigerant available in your product is specified in the Type Label.
- The installation place of the product shall not be exposed to direct sunlight and it shall not be in the vicinity of a heat source such as stoves, radiators, etc.
- The product's power cable must be unplugged during installation. Otherwise, risk of electric shock and injury may occur!
- Do not plug the product to loose, broken, dirty, greasy sockets or sockets that has come out their seats or sockets with a risk of water contact.
- Place the power cord and hoses (if available) of the product so that they shall not cause a risk of tripping over.
- Penetration of humidity to live parts or to the power cord may cause short circuit. Thus, do not use the product in humid environments or in areas where water may splash (e.g. garage, laundry room, etc.) If the refrigerator is wet by water, unplug it and contact an authorized service.
- Do not connect your refrigerator to power saving devices. These systems are harmful for the product.

If you cannot prevent installation of the product in the vicinity of a heat source, you shall use a suitable insulation plate and the minimum distance to the heat source shall be as specified below.

- At least 30 cm away from heat sources such as stoves, heating units and heaters, etc.,
- And at least 5 cm away from electric ovens.

- Your product has the protection class of I. Plug the product in a grounded socket that conforms with the Voltage, Current and Frequency values specified in the type label. The socket outlet shall be equipped with a fuse with a rating of 10 A - 16 A. Our company shall not be responsible for the damages that shall be incurred as a result of operating the product without ensuring ground and electrical connections made as per local or national regulations.

1.6 Operational safety

- Do not use chemical solvents on the product. These materials contain an explosion risk.
- In case of a failure of the product, unplug it and do not operate until it is repaired by the authorized service. There is a risk of electric shock!
- Do not place a source of flame (e.g. candles, cigarettes, etc.) on the product or in the vicinity of it.
- Do not get on the product. Risk of falling and injury!
- Do not cause damage to the pipes of the cooling system using sharp and piercing tools. The refrigerant that sprays out in case of puncturing the gas pipes, pipe extensions or upper surface coatings may cause irritation of skin and injuries of the eyes.
- Do not place and operate electric appliances inside the refrigerators/deep freezer unless it is advised by the manufacturer.

Safety instructions

- Do not jam any parts of your hands or your body to the moving parts inside the product. Be careful to prevent jamming of your fingers between the refrigerator and its door. Be careful while opening or closing the door if there are children around.
- Do not put ice cream, ice cubes or frozen food to your mouth as soon as you take them out of the freezer. Risk of frostbite!
- Do not touch the inner walls, metal parts of the freezer or food kept inside the refrigerator with wet hands. Risk of frostbite!
- Do not place soda cans or cans and bottles that contain fluids that may be frozen to the freezer compartment. Cans or bottles may explode. Risk of injury and material damage!
- Do not use or place materials sensitive against temperature such as flammable sprays, flammable objects, dry ice or other chemical agents in the vicinity of the refrigerator. Risk of fire and explosion!
- Do not store explosive materials such as aerosol cans with flammable materials inside the product.
- Do not place cans containing fluids over the product. Splashing of water on an electrical part may cause the risk of an electric shock or a fire.
- This product is not intended for storage and cooling of medicines, blood plasma, laboratory preparations or similar materials and products that are subject to the Medical Products Directive.
- If the product is used against its intended purpose, it may cause damage to or deterioration of the products kept inside.
- If your refrigerator is equipped with blue light, do not look at this light with optical devices. Do not stare directly at UV LED light for a long time. Ultraviolet rays may cause eye strain.
- Do not fill the product with more food than its capacity. Injuries or damages may occur if the contents of the refrigerator falls when the door is opened. Similar problems may occur when an object is placed over the product.
- Ensure that you have removed any ice or water that may have fallen to the floor to prevent injuries.
- Change the locations of the racks/ bottle racks on the door of your refrigerator while the racks are empty only. Danger of physical injury!
- Do not place objects that may fall/ tipped over on the product. These objects may fall while opening or closing the door and cause injuries and/or material damages.
- Do not hit or exert excessive pressure on glass surfaces. Broken glass may cause injuries and/or material damages.
- The cooling system in your product contains R600a refrigerant. The refrigerant type used in the product is specified in the the type label. This gas is flammable. Therefore, be careful not to damage the cooling system and the pipes while operating the product. In case of damage to the pipes;
 - do not touch the product or the power cord,
 - Keep the product away from potential sources of fire that may cause the product to catch fire.

Safety instructions

- ventilation the area where the product is placed. Do not use a fan.

- Contact authorized service.

- If the product is damaged and you observe gas leak, please stay away from the gas. Gas may cause frostbite if it contacts your skin.

1.7 Maintenance and cleaning safety

- Do not pull by the door handle if you shall move the product for cleaning purposes. Handle may cause injuries if it is pulled too hard.
- Do not clean the product by spraying or pouring water on the product and inside the product. Risk of electric shock and fire.
- Do not use sharp or abrasive tools to clean the product. Do not use materials such as household cleaning agents, detergents, gas, gasoline, alcohol, wax, etc.
- Use cleaning and maintenance agents that are not harmful for food only inside the product.
- Do not use steam or steamed cleaning materials for cleaning the product and thawing the ice inside it. Steam contacts the live areas in your refrigerator and causes short circuit or electric shock!
- Take care to keep water away from the electronic circuits or lighting of the product.
- Use a clean, dry cloth to wipe the dust or foreign material on the tips of the plugs. Do not use a wet or damp piece of cloth to clean the plug. Otherwise, risk of fire or electric shock may occur.

1.8 HomeWhiz

(May not be applicable for all models)

- Follow the safety warnings even if you are away from the product while operating the product via HomeWhiz app. Also, pay attention to the warnings in the app.

1.9 Lighting

(May not be applicable for all models)

- Contact an authorized service when you shall replace the LED / bulb using for lighting.

2 Environmental instructions

2.1 Compliance with the WEEE Directive and Disposing of the Waste Product:

This product complies with EU WEEE Directive (2012/19/EU). This product bears a classification symbol for waste electrical and electronic equipment (WEEE).



This symbol indicates that this product shall not be disposed with other household wastes at the end of its service life.

Used device must be returned to official collection point for recycling of electrical and electronic devices. To find these collection systems please contact to your local authorities or retailer where the product was purchased. Each household performs important role in recovering and recycling of old appliance. Appropriate disposal of used appliance helps prevent potential negative consequences for the environment and human health.

2.2 Compliance with RoHS Directive

The product you have purchased complies with EU RoHS Directive (2011/65/EU). It does not contain harmful and prohibited materials specified in the Directive.

2.3 Package information



Packaging materials of the product are manufactured from recyclable materials in accordance with our National Environment Regulations. Do not dispose of the packaging materials together with the domestic or other wastes. Take them to the packaging material collection points designated by the local authorities.

3 Your Refrigerator

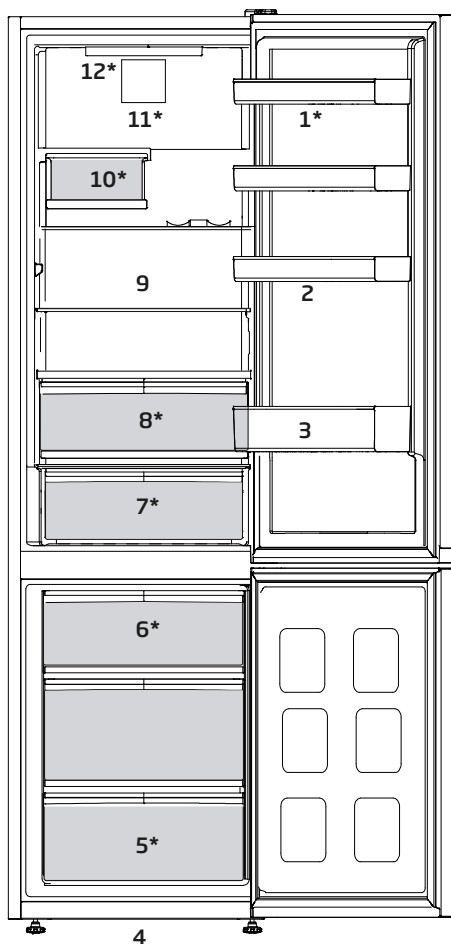

- | | | | |
|----|-------------------------|-----|---|
| 1. | Adjustable door shelves | 7. | The dairy (cold storage) bin or crisper |
| 2. | Egg tray | 8. | Crisper |
| 3. | Bottle shelf | 9. | Adjustable shelves |
| 4. | Adjustable front feet | 10. | Wine cellar |
| 5. | Freezer compartment | 11. | Fan |
| 6. | Ice container | 12. | Illumination lamp |

***May not be available in all models**



Figures that take place in this instruction manual are schematic and may not correspond exactly with your product. If the subject parts are not included in the product you have purchased, then it is valid for other models.

4 Installation

 Read the "Safety Instructions" section first!

4.1. Appropriate Installation Location

Contact an Authorized Service for the installation of the product. In order to prepare the product for use, refer the information in the user manual and ensure that electrical installation and water installation are appropriate. If not, call a qualified electrician and technician to have any necessary arrangements carried out.



WARNING: Manufacturer shall not be held liable for damages that may arise from procedures carried out by unauthorized persons.



WARNING: Product must not be plugged in during installation. Otherwise, there is the risk of death or serious injury!



WARNING: If the door clearance of the room where the product shall be placed is so tight to prevent passing of the product, remove the door of the room and pass the product through the door by turning it to its side; if this does not work, contact the authorized service.

- Place the product on an even floor surface to prevent jolts.
- Install the product at least 30 cm away from heat sources such as hobs, heater cores and stoves and at least 5 cm away from electrical ovens.
- Product must not be subjected to direct sun light and kept in humid places.

- Appropriate air ventilation must be provided around your product in order to achieve an efficient operation. If the product is to be placed in a recess in the wall, pay attention to leave at least 5 cm distance with the ceiling and side walls.
- Please provide at least 5cm distance for air circulation between the back side of your product and the wall to avoid condensation on the rear panel of product.
- Your product requires adequate air circulation to function efficiently. If the product will be placed in an alcove, remember to leave at least 5 cm clearance between the product and the ceiling, rear wall and the side walls.
- If the product will be placed in an alcove, remember to leave at least 5 cm clearance between the product and the ceiling, rear wall and the side walls. Check if the rear wall clearance protection component is present at its location (if provided with the product). If the component is not available, or if it is lost or fallen, position the product so that at least 5 cm clearance shall be left between the rear surface of the product and the wall of the room. The clearance at the rear is important for efficient operation of the product.

Installation

4.2.Adjusting the Feet

If the product stands unbalanced after installation, adjust the feet on the front by rotating them to the right or left.

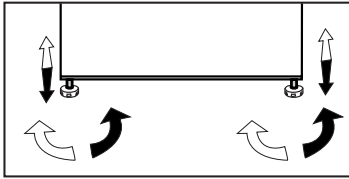

4.3.Electrical Connection

	WARNING: Do not make connections via extension cables or multi-plugs.
	WARNING: Damaged power cable must be replaced by the Authorized Service Agent.
	If two coolers are to be installed side by side, there should be at least 4 cm distance between them.

- Our company shall not be liable for any damages that will arise when the product is used without grounding and electrical connection in accordance with the national regulations.
- Power cable plug must be within easy reach after installation.
- Do not extension cords or cordless multiple outlets between your product and the wall outlet.

Hot Surface Warning!

Side walls of your product is equipped with refrigerant pipes to improve the cooling system. Refrigerant with high temperatures may flow through these areas, resulting in hot surfaces on the side walls. This is normal and does not need any servicing. Please pay attention while touching these areas.



4.4.Attaching the plastic wedges

Use the plastic wedges in the provided with the product to provide sufficient space for air circulation between the product and the wall.

1. To attach the wedges, remove the screws on the product and use the screws provided with the wedges.
2. Attach 2 plastic wedges on the ventilation cover as shown in the figure.

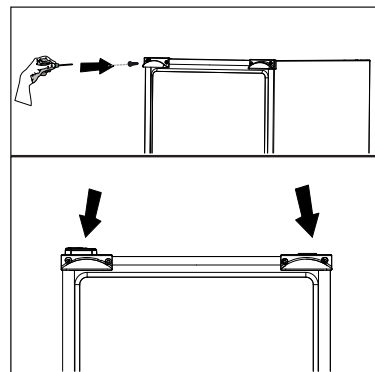

5 Preparation

! Read the “Safety Instructions” section first!

- For a freestanding appliance; this refrigerating appliance is not intended to be used as a built-in appliance.
- Your refrigerator should be installed at least 30 cm away from heat sources such as hobs, ovens, central heater and stoves and at least 5 cm away from electrical ovens and should not be located under direct sunlight.
- The ambient temperature of the room where you install your refrigerator should at least be +5°C. Operating your refrigerator under cooler conditions is not recommended with regard to its efficiency.
- Please make sure that the interior of your refrigerator is cleaned thoroughly.
- If two refrigerators are to be installed side by side, there should be at least 2 cm distance between them.
- When you operate your refrigerator for the first time, please observe the following instructions during the initial six hours.
- The door should not be opened frequently.
- It must be operated empty without any food in it.
- Do not unplug your refrigerator. If a power failure occurs out of your control, please see the warnings in the “Recommended solutions for the problems” section.
- Original packaging and foam materials should be kept for future transportations or moving.
- The baskets/drawers that are provided with the chill compartment must always be in use for low energy consumption and for better storage conditions.
- Food contact with the temperature sensor in the freezer compartment may increase energy consumption of the appliance. Thus any contact with the sensor(s) must be avoided.
- In some models, the instrument panel automatically turns off 1 minutes after the door has closed. It will be reactivated when the door has opened or pressed on any key.
- Due to temperature change as a result of opening/closing the product door during operation, condensation on the door/body shelves and the glass containers is normal.
- Since hot and humid air will not directly penetrate into your product when the doors are not opened, your product will optimize itself in conditions sufficient to protect your food. Functions and components such as compressor, fan, heater, defrost, lighting, display and so on will operate according to the needs to consume minimum energy under these circumstances.
- In case of multiple options are present glass shelves must be placed so that the air outlets at the backwall are not blocked, preferably air outlets are remaining below the glass shelf. This combination may help improving air distribution and energy efficiency.

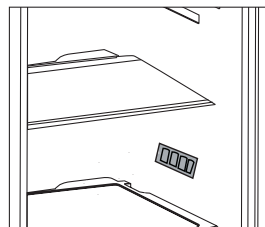

6 Operating the product

 Read the "Safety Instructions" section first!

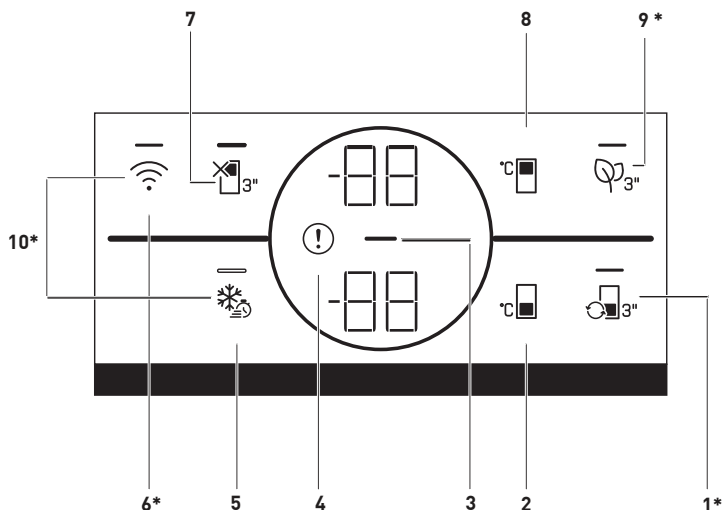

1. Compartment Conversion Key

Pressing compartment conversion key () for 3 seconds, the freezer section switches between cooler, off and freezer modes. If it is operated as the cooler compartment, the temperature will be set as 4 °C. In case of OFF mode, compartment temperature indicator shall display "--".

2. Freezing Compartment Temperature Setting Key

Temperature setting is made for cooler compartment. Pressing () key will enable the freezer compartment temperature to be set at -18,-19,-20,-21,-22,-23,-24 °C.

3. Energy Saving (Display Off) Indicator

Energy saving function is enabled automatically and the energy saving symbol () is displayed when the door of the product is not opened or closed for some period of time. When the energy saving function is active, all symbols on the screen other than the energy saving symbol shall be turned off. When the energy-saving function is active, pressing any key or opening the door will deactivate the energy-saving function and the display signals will return to normal. The energy-saving function is a function activated ex-factory and cannot be cancelled.

***May not be available in all models**



Figures in this user manual are schematic and may not match the product exactly. If the subject parts are not included in the product you have purchased, then those parts are valid for other models.

Operating the product

4. Fault Condition Indicator

This indicator (❗) shall be active when your refrigerator cannot perform adequate cooling or in case of any sensor error. On the freezer compartment temperature indicator the letter "E" and on the cooler compartment temperature indicator the numbers 1, 2, 3 will be displayed. The numbers on the indicator specifies the service regarding the failure. If you place hot food in the freezer compartment or leave its door open for a prolonged time, an exclamation mark can be lit. This is not a fault, this warning shall be removed when the food is cooled down or when any key is pressed.

5. Quick Freezing Key

When the quick freeze key is pressed, the LED on the key is illuminated and the quick freeze function shall be activated. Freezing compartment temperature is set to -27 °C. Press the key again to cancel function. The quick freezing function shall be automatically cancelled after 24 hours. To freeze a large amount of fresh food, press the quick freeze key before placing the food in the freezer compartment.

6. Wireless Key

This button (📶) is utilized to connect wirelessly to your appliance through HomeWhiz mobile application. If the button is pressed for a long time (3 secs) the LED on the button will blink (in 0.5 second intervals). The link between the appliance and the home network is initialized. After the wireless connection with the appliance is established the LED will be lit solid. After initial setup, the connection can be activated/deactivated by pressing

this button. The LED on the button shall flash quickly (at 0.2 second intervals) until the connection is established. When the connection is active, the LED shall light up continuously. If the connection cannot be established for a long period, check your connection settings and refer to the "Troubleshooting" section provided in the user manual. HomeWhiz application shall be used for wireless connection. The steps for setup are explained through the application during setup. You can access the application by scanning the QR code on the HomeWhiz label on the appliance. The application can be obtained from App Store or from Play Store for Android devices. For details visit <https://www.homewhiz.com/>.

7. Cooling Compartment OFF (Vacation) Function Key

To activate vacation function (🌞), press the button for 3 seconds. The vacation mode will be activated and the LED on the button will be lit. "--" shall be displayed on the Cooling Compartment temperature indicator and the cooling compartment does not actively perform cooling. You shall not keep your food in the cooling compartment when this function is activated. The other compartments continue to cool according to the set temperatures. Press the key for 3 seconds again to cancel this function.

8. Cooling Compartment Temperature Setting Key

Allows setting of temperature for cooler compartment (°C📄). Pressing this key will enable the cooling compartment temperature to be set at 8,7,6,5,4,3,2 and 1 °C.

Operating the product

9 Anti-Odour Module Key

Press this button for 3 seconds to activate/deactivate the anti-odour (P₃) feature. As the anti-odour feature is active, the LED on the respective button is lit. When the feature is active, the anti-odour module will be operated periodically.

10. Key for Resetting Wireless Connection Settings

To reset wireless connection settings press Quick freezing (❄️) and wireless connection (📶) buttons must be pressed for 3 seconds. On the appliance where the wireless connection settings are reset/returned to factory defaults, any prior user data set on the appliance is lost.

6.1.Changing the illumination lamp

To change the Bulb/LED used for illumination of your refrigerator, call your AuthorisedService.

The lamp(s) used in this appliance is not suitable for household room illumination. The intended purpose of this lamp is to assist the user to place foodstuffs in the refrigerator/freezer in a safe and comfortable way.

The lamps used in this appliance have to withstand extreme physical conditions such as temperatures below -20 °C.

(only chest and upright freezer)

6.2.Changing the door opening direction

Door opening direction of your refrigerator can be changed according to the place you are using it. If this is necessary, please call your nearest Authorized Service.

6.3.Open door warning

An audio warning will be given when the fridge or freezer compartment door of your product is left open for a certain period of time. This audio warning signal will mute when any button on the indicator is pressed or when the door is closed.

6.4.The dairy (cold storage) bin

Provides lower temperature within the refrigerator compartment. Use this bin to store delicatessen (salami, sausages, dairy products and etc.) that requires lower storage temperature or meat, chicken or fish products for immediate consumption. Do not store fruits and vegetables inside this bin.

6.5. Deodoriser Module (FreshGuard)

The deodoriser module quickly eliminates the bad smells in your refrigerator before they permeate the surfaces. Thanks to this module, which is placed on the ceiling of the fresh food compartment, the bad odours dissolve while the air is actively being passed on the odour filter, then the air that has been cleaned by the filter is re-emitted to the fresh food compartment. This way, the unwanted odours that may emerge during the storage of foods in the refrigerator are eliminated before they permeate the surfaces.

This is achieved thanks to the fan, LED and the odour filter integrated into the module. In daily use, the deodoriser module will turn on automatically on a periodic basis. To maintain efficient performance, it is recommended to have the filter in the deodoriser module by the authorised service provider every 5 years. Due to the fan integrated into the module, the noise you will hear during operation is normal. If you open the door of the fresh food compartment while the module is active, the fan will pause temporarily and resume where it has left off after some time the door is closed again. In case of power failure, the deodoriser module will resume where it has left off in the total operation duration once the power is back.

Info: It is recommended to store aromatic foods (such as cheese, olives and delicatessen foods) in their packaging and sealed to avoid bad odours that may result when smells of various foods get mixed. Besides, it is recommended to take spoiled foods out of the refrigerator quickly to prevent the other foods from getting spoiled and avoid bad odours.

6.6. Blue light/HarvestFresh

*May not be available in all models

For the blue light,

Fruits and vegetables stored in the crispers that are illuminated with a blue light continue their photosynthesis by means of the wavelength effect of blue light and thus preserve their vitamin content.

For HarvestFresh,

Fruits and vegetables stored in crispers illuminated with the HarvestFresh technology preserve their vitamins for a longer time thanks to the blue, green, red lights and dark cycles, which simulate a day cycle.

If you open the door of the refrigerator during the dark period of the HarvestFresh technology, the refrigerator will automatically detect this and enable the blue-green or red light to illuminate the crisper for your convenience. After you have closed the door of the refrigerator, the dark period will continue, representing the night time in a day cycle.

6.7. Moisture controlled vegetable bin

*optional

With moisture control feature, moisture rates of vegetables and fruits are kept under control and ensures a longer freshness period for foods.

It is recommended to store leafed vegetables such as lettuce and spinach and similar vegetables prone to moisture loss not on their roots but in horizontal position into the vegetable bin as much as possible.

When placing the vegetables, place heavy and hard vegetables at the bottom and light and soft ones on the top, taking into account the specific weights of vegetables.

Do not leave vegetables in the vegetable bin in plastic bags. Leaving them in plastic bags causes vegetables to rot in a short time. In situations where contact with other vegetables is not preferred, use packaging materials such as paper that has a certain porosity in terms of hygiene.

Do not put fruits that have a high ethylene gas production such as pear, apricot, peach and particularly apple in the same vegetable bin with other vegetables and fruits. The ethylene gas coming out of these fruits might cause other vegetables and fruits to mature faster and rot in a shorter period of time.

Operating the product

In order to store your fruits and vegetables at ideal humidity conditions, you can change the location of the latch on the crisper. If only fruits and vegetables are stored, set the latch to fruits; if only vegetables are stored, set the latch to vegetables, if mixed items are stored, set the latch to mixed setting.

6.8. Freezing fresh food

- 8 hours before freezing the fresh food activate the Quick Freeze function.
- To preserve food quality, the food items placed in the freezer compartment must be frozen as quickly as possible, use the rapid freezing for this.
- Freezing the food items when fresh will extend the storage time in the freezer compartment.
- Pack the food items in air-tight packs and seal tightly.
- Make sure the food items are packed before putting in the freezer. Use freezer holders, tinfoil and damp-proof paper, plastic bag or similar packaging materials instead of traditional packaging paper.



Ice in the freezing compartment thaws automatically.

- Mark each food pack by writing the date on the package before freezing. This will allow you to determine the freshness of each pack every time the freezer is opened. Keep the earlier food items in the front to ensure they are used first.
- Frozen food items must be used immediately after defrosting and should not be frozen again.
- Do not free large quantities of food at once.

Operating the product

Freezer Compartment Temperature Setting	Cooler Compartment Temperature Setting	Details
-18°C	4°C	This is the default, recommended setting.
-20,-22 or -24°C	4°C	These settings are recommended for ambient temperatures exceeding 30°C.
Quick Freeze	4°C	Use when you want to freeze your food in a short time. When the process ends, the product will regain its position.
-18°C or colder	2°C	Use these settings if you believe the cooler compartment is not cold enough due to ambient temperature or frequently opening the door.

6.9.Recommendations for storing frozen foods

The compartment must be set to at least -18°C.

1. Place the food items in the freezer as quickly as possible to avoid defrosting.
2. Before freezing, check the “Expiry Date” on the package to make sure it is not expired.
3. Make sure the food’s packaging is not damaged.

Boil the vegetables and filter the water to extend the frozen storage time.

Place the food in air-tight packages after filtering and place in the freezer. Bananas, tomatoes, lettuce, celery, boiled eggs, potatoes and similar food items should not be frozen. In case this food rots, only nutritional values and eating qualities will be negatively affected. A rotting threatening human health is not in question.

6.10.Deep freezer details

As per the IEC 62552 standards, the freezer must have the capacity to freeze 4,5 kg of food items at -18°C or lower temperatures in 24 hours for each 100 litres of freezer compartment volume.

Food items can only be preserved for extended periods at or below temperature of -18°C .

You can keep the foods fresh for months (in deep freezer at or below temperatures of 18°C).

The food items to be frozen must not contact the already-frozen food inside to avoid partial defrosting.

6.11.Placing the food

Freezer compartment shelves	Various frozen goods including meat, fish, ice cream, vegetables etc.
Cooler compartment shelves	Food items inside pots, capped plate and capped cases, eggs (in capped case)
Cooler compartment door shelves	Small and packed food or beverages
Vegetable bin	Fruits and vegetables
Fresh food compartment	Delicatessen (breakfast food, meat products to be consumed in short notice)

7 Maintenance and cleaning

-  Read the "Safety Instructions" section first!
-  Never use gasoline, benzene or similar substances for cleaning purposes.
-  We recommend that you unplug the appliance before cleaning.
-  Never use any sharp abrasive instrument, soap, household cleaner, detergent and wax polish for cleaning.
-  For non-No Frost products, water drops and frosting up to a fingerbreadth occur on the rear wall of the Fridge compartment. Do not clean it; never apply oil or similar agents on it.
-  Only use slightly damp microfiber cloths to clean the outer surface of the product. Sponges and other types of cleaning cloths may scratch the surface.
-  Use lukewarm water to clean the cabinet of your refrigerator and wipe it dry.
-  Use a damp cloth wrung out in a solution of one teaspoon of bicarbonate of soda to one pint of water to clean the interior and wipe it dry.
-  Make sure that no water enters the lamp housing and other electrical items.
-  If your refrigerator is not going to be used for a long period of time, unplug the power cable, remove all food, clean it and leave the door ajar.
-  Check door seals regularly to ensure they are clean and free from food particles.
-  To remove door racks, remove all the contents and then simply push the door rack upwards from the base.
-  Never use cleaning agents or water that contain chlorine to clean the outer surfaces and chromium coated parts of the product. Chlorine causes corrosion on such metal surfaces.
-  Do not use sharp, abrasive tools, soap, household cleaning agents, detergents, kerosene, fuel oil, varnish etc. to prevent removal and deformation of the prints on the plastic part. Use lukewarm water and a soft cloth for cleaning and then wipe it dry.

Protection of plastic surfaces

-  Do not put the liquid oils or oil-cooked meals in your refrigerator in unsealed containers as they damage the plastic surfaces of your refrigerator. In case of spilling or smearing oil on the plastic surfaces, clean and rinse the relevant part of the surface at once with warm water.

8 Troubleshooting

Please review this list before calling the service. It will save your time and money. This list includes frequent complaints that are not arising from defective workmanship or material usage. Some of the features described here may not exist in your product.

The refrigerator does not operate.

- The plug is not inserted into the socket correctly. >>>Insert the plug into the socket securely.
- The fuse of the socket which your refrigerator is connected to or the main fuse have blown out. >>>Check the fuse.

Condensation on the side wall of the fridge compartment (MULTIZONE, COOL CONTROL and FLEXI ZONE).

- Door has been opened frequently. >>>Do not open and close the door of refrigerator frequently.
- Ambient is very humid. >>>Do not install your refrigerator into highly humid places.
- Food containing liquid is stored in open containers. >>>Do not store food with liquid content in open containers.
- Door of the refrigerator is left ajar. >>>Close the door of the refrigerator.
- Thermostat is set to a very cold level. >>>Set the thermostat to a suitable level.

Compressor is not running

- Protective thermic of the compressor will blow out during sudden power failures or plug-out plug-ins as the refrigerant pressure in the cooling system of the refrigerator has not been balanced yet. The refrigerator will start running approximately after 6 minutes. Please call the service if the refrigerator does not startup at the end of this period.
- The fridge is in defrost cycle. >>>This is normal for a full-automatically defrosting refrigerator. Defrosting cycle occurs periodically.
- The refrigerator is not plugged into the socket. >>>Make sure that the plug is fit into the socket.
- Temperature settings are not made correctly. >>>Select the suitable temperature value.
- There is a power outage. >>>Refrigerator returns to normal operation when the power restores.

The operation noise increases when the refrigerator is running.

- The operating performance of the refrigerator may change due to the changes in the ambient temperature. It is normal and not a fault.

The refrigerator is running frequently or for a long time.

Troubleshooting

- New product may be wider than the previous one. Larger refrigerators operate for a longer period of time.
- The room temperature may be high. >>>It is normal that the product operates for longer periods in hot ambient.
- The refrigerator might be plugged in recently or might be loaded with food. >>>When the refrigerator is plugged in or loaded with food recently, it will take longer for it to attain the set temperature. This is normal.
- Large amounts of hot food might be put in the refrigerator recently. >>>Do not put hot food into the refrigerator.
- Doors might be opened frequently or left ajar for a long time. >>>The warm air that has entered into the refrigerator causes the refrigerator to run for longer periods. Do not open the doors frequently.
- Freezer or fridge compartment door might be left ajar. >>>Check if the doors are closed completely.
- The refrigerator is adjusted to a very low temperature. >>>Adjust the refrigerator temperature to a warmer degree and wait until the temperature is achieved.
- Door seal of the fridge or freezer may be soiled, worn out, broken or not properly seated. >>>Clean or replace the seal. Damaged/broken seal causes the refrigerator to run for a longer period of time in order to maintain the current temperature.

Freezer temperature is very low while the fridge temperature is sufficient.

- The freezer temperature is adjusted to a very low value. >>>Adjust the freezer temperature to a warmer degree and check.

Fridge temperature is very low while the freezer temperature is sufficient.

- The fridge temperature is adjusted to a very low value. >>>Adjust the fridge temperature to a warmer degree and check.

Food kept in the fridge compartment drawers is frozen.

- The fridge temperature is adjusted to a very high value. >>>Adjust the fridge temperature to a lower value and check.

Temperature in the fridge or freezer is very low.

- The fridge temperature is adjusted to a very high value. >>>Fridge compartment temperature setting has an effect on the temperature of the freezer. Change the temperatures of the fridge or freezer and wait until the relevant compartments attain a sufficient temperature.
- Doors are opened frequently or left ajar for a long time. >>>Do not open the doors frequently.
- Door is ajar. >>>Close the door completely.
- The refrigerator is plugged in or loaded with food recently. >>>This is normal. When the refrigerator is plugged in or loaded with food recently, it will take longer for it to attain the set temperature.
- Large amounts of hot food might be put in the refrigerator recently. >>>Do not put hot food into the refrigerator.

• Vibrations or noise.

- The floor is not level or stable. >>> If the refrigerator rocks when moved slowly, balance it by adjusting its feet. Also make sure that the floor is strong enough to carry the refrigerator, and level.
- The items put onto the refrigerator may cause noise. >>>Remove the items on top of the refrigerator.

Troubleshooting

There are noises coming from the refrigerator like liquid flowing, spraying, etc.

- Liquid and gas flows occur in accordance with the operating principles of your refrigerator. It is normal and not a fault.

Whistle comes from the refrigerator.

- Fans are used in order to cool the refrigerator. It is normal and not a fault.

Condensation on the inner walls of refrigerator.

- Hot and humid weather increases icing and condensation. It is normal and not a fault.
- Doors are opened frequently or left ajar for a long time. >>> Do not open the doors frequently. Close them if they are open.
- Door is ajar. >>> Close the door completely.

Humidity occurs on the outside of the refrigerator or between the doors.

- There might be humidity in the air; this is quite normal in humid weather. When the humidity is less, condensation will disappear.

Bad odour inside the refrigerator.

- No regular cleaning is performed. >>> Clean the inside of the refrigerator regularly with a sponge, lukewarm water or carbonate dissolved in water.
- Some containers or package materials may cause the smell. >>> Use a different container or different brand packaging material.
- Food is put into the refrigerator in uncovered containers. >>> Keep the food in closed containers. Microorganisms spreading out from uncovered containers can cause unpleasant odours.
- Remove the foods that have expired best before dates and spoiled from the refrigerator.

The door is not closing.

- Food packages are preventing the door from closing. >>> Replace the packages that are obstructing the door.
- The refrigerator is not completely even on the floor. >>> Adjust the feet to balance the refrigerator.
- The floor is not level or strong. >>> Make sure that the floor is level and capable to carry the refrigerator.

Crispers are stuck.

- The food is touching the ceiling of the drawer. >>> Rearrange food in the drawer.

If The Surface Of The Product Is Hot.

- High temperatures may be observed between the two doors, on the side panels and at the rear grill while the product is operating. This is normal and does not require service maintenance!

DISCLAIMER / WARNING

Some (simple) failures can be adequately handled by the end-user without any safety issue or unsafe use arising, provided that they are carried out within the limits and in accordance with the following instructions (see the "Self-Repair" section).

Therefore, unless otherwise authorized in the "Self-Repair" section below, repairs shall be addressed to registered professional repairers in order to avoid safety issues. A registered professional repairer is a professional repairer that has been granted access to the instructions and spare parts list of this product by the manufacturer according to the methods described in legislative acts pursuant to Directive 2009/125/EC.

However, only the service agent (i.e. authorized professional repairers) that you can reach through the phone number given in the user manual/warranty card or through your authorized dealer may provide service under the guarantee terms. Therefore, please be advised that repairs by professional repairers (who are not authorized by Beko) shall void the guarantee.

Self-Repair

Self-repair can be done by the end-user with regard to the following spare parts: door handles, door hinges, trays, baskets and door gaskets (an updated list is also available in support.beko.com as of 1st March 2021).

Moreover, to ensure product safety and to prevent risk of serious injury, the mentioned self-repair shall be done following the instructions in the user manual for self-repair or which are available in support.beko.com. For your safety, unplug the product before attempting any self-repair.

Repair and repair attempts by end-users for parts not included in such list and/or not following the instructions in the user manuals for self-repair or which are available in support.beko.com, might give rise to safety issues not attributable to Beko, and will void the warranty of the product.

Therefore, it is highly recommended that end-users refrain from the attempt to carry out repairs falling outside the mentioned list of spare parts, contacting in such cases authorized professional repairers or registered professional repairers. On the contrary, such attempts by end-users may cause safety issues and damage the product and subsequently cause fire, flood, electrocution and serious personal injury to occur.

By way of example, but not limited to, the following repairs must be addressed to authorized professional repairers or registered professional repairers: compressor, cooling circuit, main board, inverter board, display board, etc.

The manufacturer/seller cannot be held liable in any case where end-users do not comply with the above.

The spare part availability of the refrigerator that you purchased is 10 years. During this period, original spare parts will be available to operate the refrigerator properly

The minimum duration of guarantee of the refrigerator that you purchased is 24 months.