



Built-in Oven
User Manual



BVM35400XS

EN

285.4604.59/R.Aj/12.07.2021/12-1
7768287660

Please read this user manual first!

Dear Customer,

Thank you for purchasing this Beko product. We hope that you get the best results from your product which has been manufactured with high quality and state-of-the-art technology. Therefore, please read this entire user manual and all other accompanying documents carefully before using the product and keep it as a reference for future use. If you handover the product to someone else, give the user manual as well. Follow all warnings and information in the user manual.

Remember that this user manual is also applicable for several other models. Differences between models will be identified in the manual.

Explanation of symbols

Throughout this user manual the following symbols are used:



Important information or useful hints about usage.



Warning of hazardous situations with regard to life and property.



Warning of electric shock.



Warning of risk of fire.



Warning of hot surfaces.



Arçelik A.Ş.
Karaağaç caddesi No:2-6
34445 Söğütözü/İstanbul/TURKEY

Made in TURKEY

This product was manufactured using the latest technology in environmentally friendly conditions.

TABLE OF CONTENTS

1 Important instructions and warnings for safety and environment 4

General safety.....	4
Electrical safety.....	5
Product safety.....	6
Intended use.....	8
Safety for children.....	8
Disposing of the old product.....	8
Package information.....	9

2 General information 10

Overview.....	10
Package contents.....	11
Technical specifications.....	12

3 Installation 13

Before installation.....	13
Installation and connection.....	14
Future Transportation.....	16

4 Preparation 17

Tips for saving energy.....	17
Initial use.....	17
Initial time setting.....	17
First cleaning of the appliance.....	18

Initial heating.....	18
----------------------	----

5 How to operate the oven 19

General information on baking, roasting and grilling.....	19
How to operate the electric oven.....	20
Oven functions.....	21
How to operate the oven control unit.....	25
Cooking times table.....	39
Pizza menu recipes.....	44
How to operate the grill.....	50

6 Maintenance and care 53

General cleaning information.....	53
Cleaning the accessories.....	54
Cleaning the control panel.....	54
Cleaning the inside of the oven (cooking area).....	54
Cleaning the oven door.....	55
Removing the door inner glass.....	56
Cleaning the oven lamp.....	56

7 Troubleshooting 58

1 Important instructions and warnings for safety and environment

This section contains safety instructions that will help protect from risk of personal injury or property damage. Failure to follow these instructions shall void any warranty.

General safety

- This appliance can be used by children aged from 8 years and above and persons with reduced physical, sensory or mental capabilities or lack of experience and knowledge if they have been given supervision or instruction concerning use of the appliance in a safe way and understand the hazards involved.

Children shall not play with the appliance. Cleaning and user maintenance shall not be made by children without supervision.

- The appliance is not to be used by persons (including children) with reduced physical, sensory or mental capabilities, or lack of experience and knowledge,

unless they have been given supervision or instruction.

Children should be supervised and ensure they do not play with the appliance

- If the product is handed over to someone else for personal use or second-hand use purposes, the user manual, product labels and other relevant documents and parts should be also given.
- Installation and repair procedures must always be performed by Authorised Service Agents. The manufacturer shall not be held responsible for damages arising from procedures carried out by unauthorised persons which may also void the warranty. Before installation, read the instructions carefully.
- Do not operate the product if it is defective or has any visible damage.
- Ensure that the product function knobs are switched off after every use.

Electrical safety

- If the product has a failure, it should not be operated unless it is repaired by an Authorised Service Agent. There is the risk of electric shock!
- Only connect the product to a grounded outlet/line with the voltage and protection as specified in the “Technical specifications”. Have the grounding installation made by a qualified electrician while using the product with or without a transformer. Our company shall not be liable for any problems arising due to the product not being earthed in accordance with the local regulations.
- Never wash the product by spreading or pouring water onto it! There is the risk of electric shock!
- Never touch the plug with wet hands! Never unplug by pulling on the cable, always pull out by holding the plug.
- The product must be disconnected during installation, maintenance, cleaning and repairing procedures.
- If the power connection cable for the product is damaged, it must be replaced by the manufacturer, its service agent or similarly qualified persons in order to avoid a hazard.
- The appliance must be installed so that it can be completely disconnected from the mains supply. The separation must be provided by a switch built into the fixed electrical installation, according to construction regulations.
- Rear surface of the oven gets hot when it is in use. Make sure that the electrical connection does not contact with the rear surface; otherwise, connections can get damaged.
- Do not trap the mains cable between the oven door and frame and do not route it over hot surfaces. Otherwise, cable insulation may melt and cause fire as a result of short circuit.
- Any work on electrical equipment and systems should only be carried out by authorised and qualified persons.

- In case of any damage, switch off the product and disconnect it from the mains. To do this, turn off the fuse at home.
- Make sure that fuse rating is compatible with the product.

Product safety

- **WARNING:** The appliance and its accessible parts become hot during use. Care should be taken to avoid touching heating elements. Children less than 8 years of age shall be kept away unless continuously supervised.
- Never use the product when your judgment or coordination is impaired by the use of alcohol and/or drugs.
- Be careful when using alcoholic drinks in your dishes. Alcohol evaporates at high temperatures and may cause fire since it can ignite when it comes into contact with hot surfaces.
- Food Poisoning Hazard: Do not let food sit in oven for more than 1 hour before or after cooking. Doing so can result in food poisoning or sickness.
- Do not place any flammable materials close to the product as the sides may become hot during use.
- During use the appliances becomes hot. Care should be taken to avoid touching heating elements inside the oven.
- Keep all ventilation slots clear of obstructions.
- Do not heat closed tins and glass jars in the oven. The pressure that would build-up in the tin/jar may cause it to burst.
- Do not place baking trays, dishes or aluminium foil directly onto the bottom of the oven. The heat accumulation might damage the bottom of the oven.
- Do not use harsh abrasive cleaners or sharp metal scrapers to clean the oven door glass since they can scratch the surface, which may result in shattering of the glass.
- Do not use steam cleaners to clean the appliance as this may cause an electric shock.

- (Varies depending on the product model.)

Placing the wire shelf and tray onto the wire racks properly

It is important to place the wire shelf and/or tray onto the rack properly. Slide the wire shelf or tray between 2 rails and make sure that it is balanced before placing food on it (Please see the following figure).

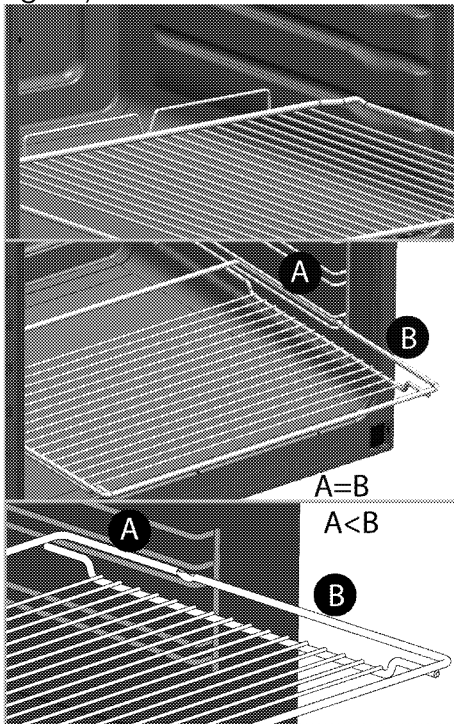

- Do not use the product if the front door glass is removed or cracked.

- Always use heat resistant oven gloves when putting in or removing dishes into/from the hot oven.
- Place the baking paper into the cooking pot or on to the oven accessory (tray, wire grill etc) together with the food and then insert all into the preheated oven. Remove the excess parts of the baking paper overflowing from the accessory or the pot in order to prevent the risk of touching the oven's heating elements. Never use the baking paper in an operating temperature higher than the indicated value for the baking paper. Do not place the baking paper directly on the base of the oven.
- **WARNING:** Ensure that power cord of the appliance is unplugged or circuit breaker is switched off before replacing the lamp to avoid the possibility of electric shock.
- The appliance must not be installed behind a decorative door in order to avoid overheating.

Prevention against possible fire risk!

- Ensure all electrical connections are secure and tight to prevent risk of arcing.
- Do not use damaged cables or extension cables.
- Ensure liquid or moisture is not accessible to the electrical connection point.

Intended use

- This product is designed for domestic use. Commercial use will void the guarantee.
- **CAUTION:** This appliance is for cooking purposes only. It must not be used for other purposes, for example room heating.
- This product should not be used for warming the plates under the grill, drying towels, dish cloths etc. by hanging them on the oven door handles. This product should also not be used for room heating purposes.
- The manufacturer shall not be liable for any damage caused by improper use or handling errors.
- The oven can be used for defrosting, baking, roasting and grilling food.

Safety for children

- **WARNING:** Accessible parts may become hot during use. Young children should be kept away.
- The packaging materials will be dangerous for children. Keep the packaging materials away from children. Please dispose of all parts of the packaging according to environmental standards.
- Electrical products are dangerous to children. Keep children away from the product when it is operating and do not allow them to play with the product.
- Do not place any items above the appliance that children may reach for.
- When the door is open, do not load any heavy object on it and do not allow children to sit on it. It may overturn or door hinges may get damaged.

Disposing of the old product

Compliance with the WEEE Directive and Disposing of the Waste Product:



This product complies with EU WEEE Directive (2012/19/EU). This product bears a classification symbol for waste

electrical and electronic equipment (WEEE).

This product has been manufactured with high quality parts and materials which can be reused and are suitable for recycling. Do not dispose of the waste product with normal domestic and other wastes at the end of its service life. Take it to the collection center for the recycling of electrical and electronic equipment. Please consult your local authorities to learn about these collection centers.

Compliance with RoHS Directive:

The product you have purchased complies with EU RoHS Directive

(2011/65/EU). It does not contain harmful and prohibited materials specified in the Directive.

Package information

- Packaging materials of the product are manufactured from recyclable materials in accordance with our National Environment Regulations. Do not dispose of the packaging materials together with the domestic or other wastes. Take them to the packaging material collection points designated by the local authorities.

2 General information

Overview

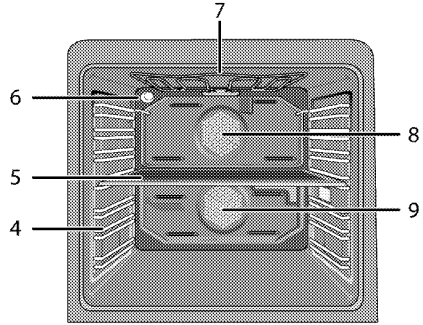
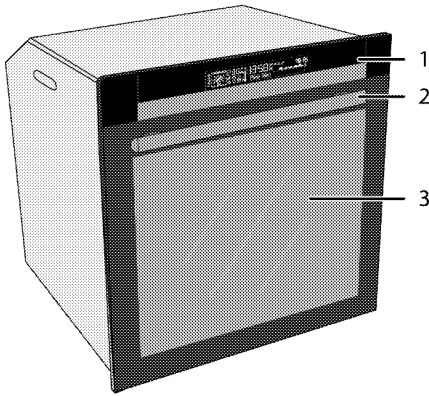

- | | |
|------------------------|--|
| 1 Control panel | 7 Top heating element |
| 2 Handle | 8 Top section fan motor (behind the sheet iron) |
| 3 Front door | 9 Bottom section fan motor (behind the sheet iron) |
| 4 Shelf positions | |
| 5 Middle section plate | |
| 6 Lamp | |

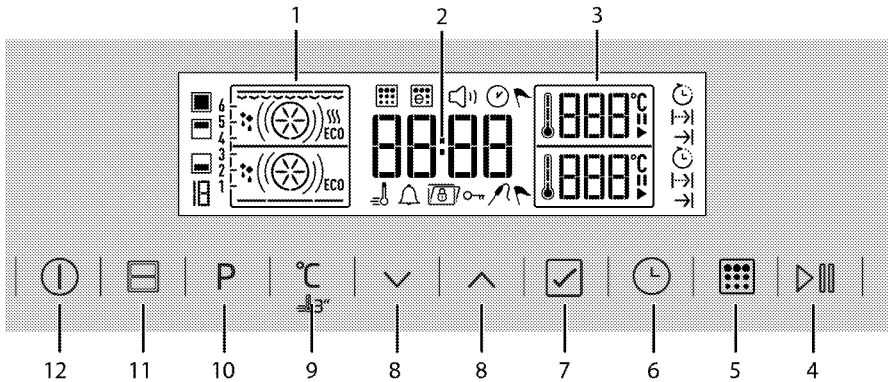

- | | |
|-----------------------------------|--|
| 1 Function display | 10 Function selection key |
| 2 Current time indicator field | 11 Oven section selection key |
| 3 Temperature indicator field | 12 ON/OFF key |
| 4 Start/stop cooking key | * (Varies depending on the product model.) |
| 5 Pyro key* | |
| 6 Time and settings key | |
| 7 Confirmation key | |
| 8 Up/down keys | |
| 9 Temperature/booster setting key | |

Package contents

i Accessories supplied can vary depending on the product model. Not every accessory described in the user manual may exist on your product.

1. User manual

2. Standard tray

Used for pastries, frozen foods and big roasts.

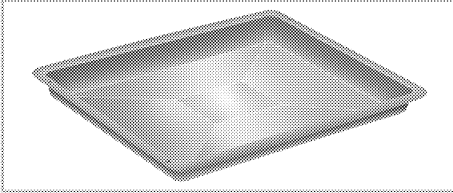

3. Wire grill

Used for roasting and for placing the food to be baked, roasted or cooked in casserole dishes to the desired rack.

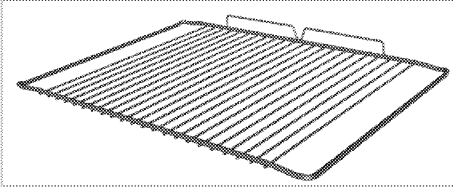
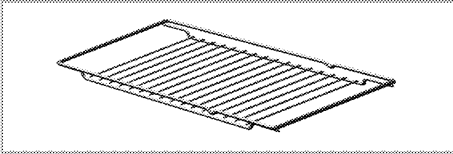

4. Placing the wire shelf and tray onto the telescopic racks properly (This feature is optional. It may not exist on your product.)

Telescopic racks allow you to install and remove the trays and wire shelf easily.

When using the tray and wire shelf with telescopic racks, make sure that the pins at the rear section of the telescopic rack stands against the edges of the wire shelf and tray.

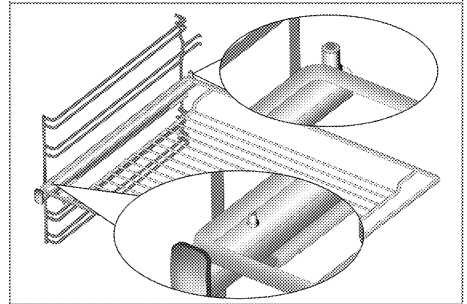
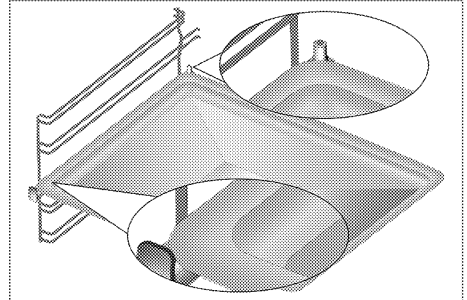

Technical specifications

Voltage / frequency	220-240 V ~ 50 Hz
Total power consumption	3,5kW
Cable type / section	min.H05VV-FG 3 x 1,5 mm ²
External dimensions (height / width / depth)	595 mm/594 mm/567 mm
Installation dimensions (height / width / depth)	**590 or 600 mm/560 mm/min. 550 mm
Main oven	Multifunction oven - Dual section oven
Inner lamp	15/25 W
Grill power consumption	2.2 kW

Basics: Information on the energy label of electrical ovens is given in accordance with the EN 60350-1 / IEC 60350-1 standard. Those values are determined under standard load with bottom-top heater or fan assisted heating (if any) functions.

Energy efficiency class is determined in accordance with the following prioritization depending on whether the relevant functions exist on the product or not. 1-Cooking with eco-fan, 2- Turbo slow cooking, 3- Turbo cooking, 4- Fan assisted bottom/top heating, 5-Top and bottom heating.

** See. *Installation*, page 13.

i Technical specifications may be changed without prior notice to improve the quality of the product.

i Figures in this manual are schematic and may not exactly match your product.

i Values stated on the product labels or in the documentation accompanying it are obtained in laboratory conditions in accordance with relevant standards. Depending on operational and environmental conditions of the product, these values may vary.

3 Installation

Product must be installed by a qualified person in accordance with the regulations in force. The manufacturer shall not be held responsible for damages arising from procedures carried out by unauthorized persons which may also void the warranty.

 Preparation of location and electrical installation for the product is under customer's responsibility.

 The product must be installed in accordance with all local electrical regulations.

 Prior to installation, visually check if the product has any defects on it. If so, do not have it installed. Damaged products cause risks for your safety.

Before installation

The appliance is intended for installation in commercially available kitchen cabinets. A safety distance must be left between the appliance and the kitchen

walls and furniture. See figure (values in mm).

- Surfaces, synthetic laminates and adhesives used must be heat resistant (100 °C minimum).
- Kitchen cabinets must be set level and fixed.
- If there is a drawer beneath the oven, a shelf must be installed between oven and drawer.
- Carry the appliance with at least two persons.

 Do not install the appliance next to refrigerators or freezers. The heat emitted by the appliance will lead to an increased energy consumption of cooling appliances.

 The door and/or handle must not be used for lifting or moving the appliance.

 If the appliance has wire handles, push the handles back into the side walls after moving the appliance.

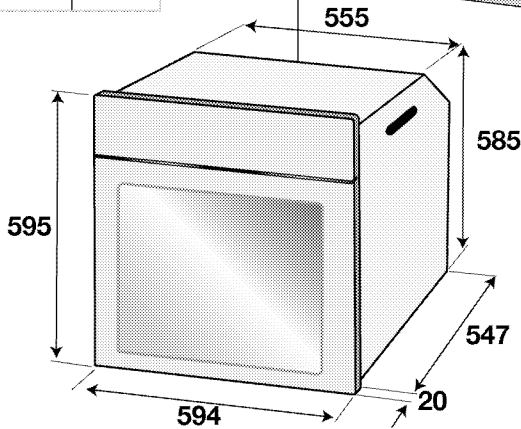
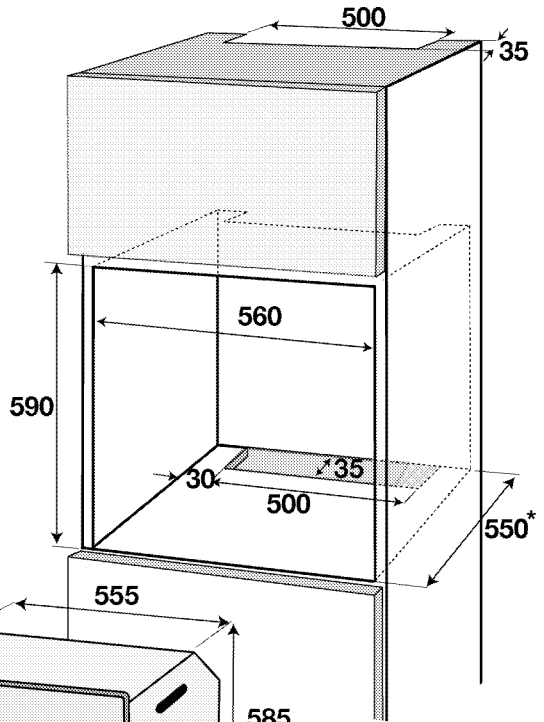
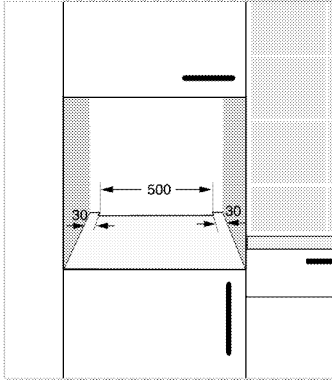
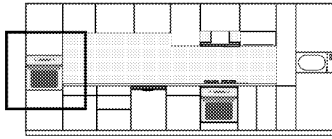

* min.

Installation and connection

- The product must be installed in accordance with all local gas and electrical regulations.

Electrical connection

Connect the product to a grounded outlet/line protected by a miniature circuit breaker of suitable capacity as stated in the "Technical specifications" table. Have the grounding installation

made by a qualified electrician while using the product with or without a transformer. Our company shall not be liable for any damages that will arise due to using the product without a grounding installation in accordance with the local regulations.

! The product must be connected to the mains supply only by an authorised and qualified person. The product's warranty period starts only after correct installation.

Manufacturer shall not be held responsible for damages arising from procedures carried out by unauthorised persons.

! The power cable must not be clamped, bent or trapped or come into contact with hot parts of the product.

A damaged power cable must be replaced by a qualified electrician. Otherwise, there is risk of electric shock, short circuit or fire!

- Connection must comply with national regulations.
- The mains supply data must correspond to the data specified on the type label of the product. Open the front door to see the type label.
- Power cable of your product must comply with the values in "Technical specifications" table.

! Before starting any work on the electrical installation, disconnect the product from the mains supply.

There is the risk of electric shock!

i Power cable plug must be within easy reach after installation (do not route it above the hob).

i While performing the wiring, you must apply with the national/local electrical regulations and must use the appropriate socket outlet/line and plug for oven. In case of the product's power limits are out of current carrying capability of plug and socket outlet/line, the product must be connected through fixed electrical installation directly without using plug and socket outlet/line.

Plug the power cable into the socket.

Installing the product

1. Slide the oven into the cabinet, align and secure it while making sure that the power cable is not broken and/or trapped.

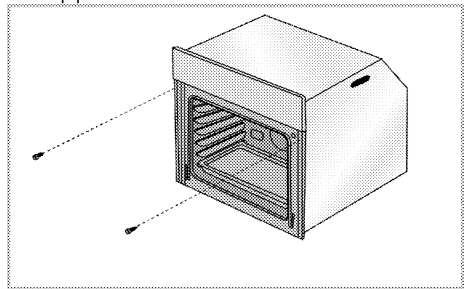

Secure the oven with 2 screws as illustrated.

After the installation, make sure that the screws are sufficiently tightened and the oven does not move. Oven may tip over during use if it is not installed as per the instructions and if the screws are not sufficiently tightened.

For products with cooling fan (This may not exist on your product.)

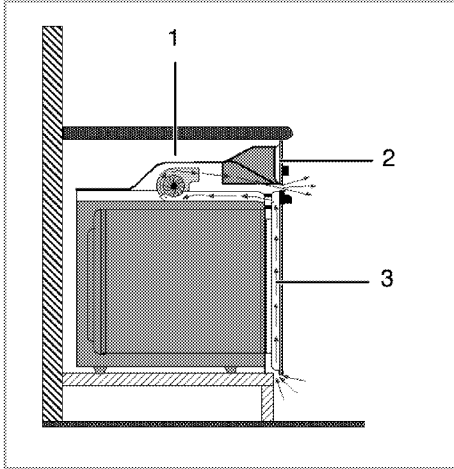

- 1 Cooling fan
- 2 Control panel
- 3 Door

The built-in cooling fan cools both the built-in cabinet and the front of the product.

i Cooling fan continues to operate for about 20-30 minutes after the oven is switched off.

If you have cooked by programming the timer of the oven, cooling fan will also be switched off at the end of the cooking time together with all functions.

Final check

1. Operate the product.
2. Check the functions.

Future Transportation

- Keep the product's original carton and transport the product in it. Follow the instructions on the carton. If you do not have the original carton, pack the product in bubble wrap or thick cardboard and tape it securely.
- To prevent the wire grill and tray inside the oven from damaging the oven door, place a strip of cardboard onto the inside of the oven door that lines up with the position of the trays. Tape the oven door to the side walls.
- Do not use the door or handle to lift or move the product.

i Do not place any objects onto the product and move it in upright position.

i Check the general appearance of your product for any damages that might have occurred during transportation.

4 Preparation

Tips for saving energy

The following information will help you to use your appliance in an ecological way, and to save energy:

- Use dark coloured or enamel coated cookware in the oven since the heat transmission will be better.
- While cooking your dishes, perform a preheating operation if it is advised in the user manual or cooking instructions.
- Do not open the door of the oven frequently during cooking.

- Try to cook more than one dish in the oven at the same time whenever possible. You can cook by placing two cooking vessels onto the wire shelf.
- Cook more than one dish one after another. The oven will already be hot.
- You can save energy by switching off your oven a few minutes before the end of the cooking time. Do not open the oven door.
- Defrost frozen dishes before cooking them.

Initial use

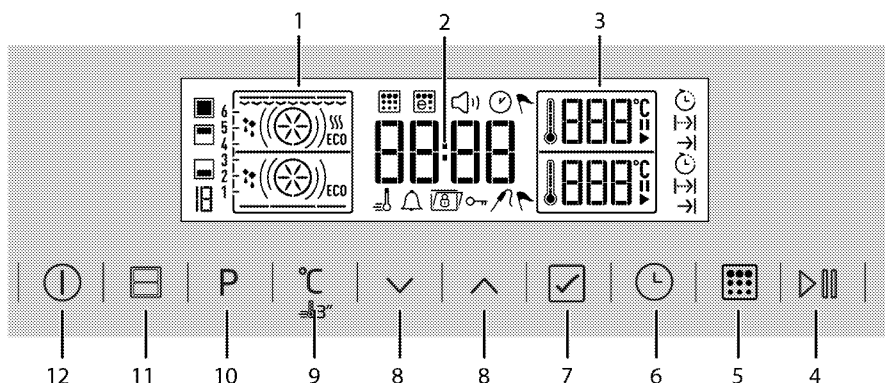

Initial time setting







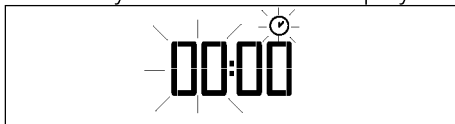

- 1 Function display
- 2 Current time indicator field
- 3 Temperature indicator field
- 4 Start/stop cooking key
- 5 Pyro key*
- 6 Time and settings key
- 7 Confirmation key
- 8 Up/down keys
- 9 Temperature/booster setting key
- 10 Function selection key
- 11 Oven section selection key
- 12 ON/OFF key

* (Varies depending on the product model.)

Set the initial time

1. Touch  key at short intervals until  appears on the display. Hour field and  will symbol flash on the display.



2. Use  to set the hour field.
3. Touch  to confirm the setting.
4. Minute field and  symbol will flash. Set the minute with  keys. Touch  to confirm the minute.



» It returns to the stand-by display. Only the current time appears on the display.



First cleaning of the appliance

- i** The surface might get damaged by some detergents or cleaning materials.
Do not use aggressive detergents, cleaning powders/creams or any sharp objects during cleaning.
Do not use harsh abrasive cleaners or sharp metal scrapers to clean the oven door glass since they can scratch the surface, which may result in shattering of the glass.

1. Remove all packaging materials.
2. Wipe the surfaces of the appliance with a damp cloth or sponge and dry with a cloth.

Initial heating

Heat up the product for about 30 minutes and then switch it off. Thus, any production residues or layers will be burnt off and removed.



Hot surfaces cause burns!

Product may be hot when it is in use. Never touch the hot burners, inner sections of the oven, heaters and etc. Keep children away. Always use heat resistant oven gloves when putting in or removing dishes into/from the hot oven.

Electric oven

1. Take all baking trays and the wire grill out of the oven.
2. Close the oven door.
3. Select Static position.

Grill oven

1. Take all baking trays and the wire grill out of the oven.
2. Close the oven door.
3. Select the highest grill power; see .
4. Operate the grill about 15 minutes.
5. Turn off your grill; see



Smoke and smell may emit for a couple of hours during the initial operation. This is quite normal. Ensure that the room is well ventilated to remove the smoke and smell. Avoid directly inhaling the smoke and the smell that emits.

5 How to operate the oven

General information on baking, roasting and grilling

 Hot surfaces cause burns! Product may be hot when it is in use. Never touch the hot burners, inner sections of the oven, heaters and etc. Keep children away. Always use heat resistant oven gloves when putting in or removing dishes into/from the hot oven.

 Be careful when opening the oven door as steam may escape. Exiting steam can scald your hands, face and/or eyes.

Tips for baking

- Use non-sticky coated appropriate metal plates or aluminum vessels or heat-resistant silicone moulds.
- Make best use of the space on the rack.
- Place the baking mould in the middle of the shelf.
- Select the correct rack position before turning the oven or grill on. Do not change the rack position when the oven is hot.
- Keep the oven door closed.

Tips for roasting

- Treating whole chicken, turkey and large piece of meat with dressings such as lemon juice and black pepper before cooking will increase the cooking performance.
- It takes about 15 to 30 minutes longer to roast meat with bones when compared to roasting the same size of meat without bones.

- Each centimeter of meat thickness requires approximately 4 to 5 minutes of cooking time.
- Let meat rest in the oven for about 10 minutes after the cooking time is over. The juice is better distributed all over the roast and does not run out when the meat is cut.
- Fish should be placed on the middle or lower rack in a heat-resistant plate.

Tips for grilling

When meat, fish and poultry are grilled, they quickly get brown, have a nice crust and do not get dry. Flat pieces, meat skewers and sausages are particularly suited for grilling as are vegetables with high water content such as tomatoes and onions.

- Distribute the pieces to be grilled on the wire shelf or in the baking tray with wire shelf in such a way that the space covered does not exceed the size of the heater.
- Slide the wire shelf or baking tray with grill into the desired level in the oven. If you are grilling on the wire shelf, slide the baking tray to the lower rack to collect fats. The baking tray to be slid must be of a size that covers the whole grilling area. This tray might not be provided with the product. Add some water in the baking tray for easy cleaning.



Foods that are not suitable for grilling carry the risk of fire. Only grill food which is suitable for intensive grilling heat. Do not place the food too far in the back of the grill. This is the hottest area and fatty food may catch fire.

How to operate the electric oven

Rack positions

There are 6 racks suitable for use in your oven, 3 of which are in lower section and 3 of which are in upper section. There is another rack guide in the gap where middle section plate (A) will be installed. Do not use this canal as a rack while cooking.

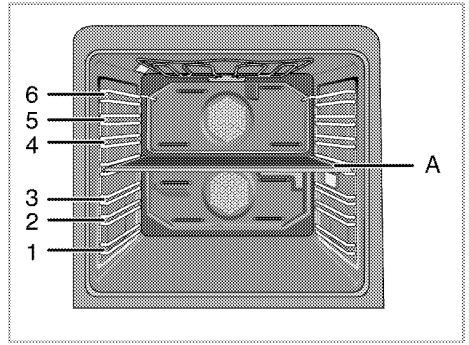

You can cook in 4 different sections of your oven.

	Upper section	You can only cook in upper section. It is suitable for grill and small sized cookings.	When upper section is active, temperature value, rack positions, cooking symbol, stand-by symbol, cooking time symbol and cooking end time symbol of this section appear on the display.
	Lower section	You can only cook in lower section. It is suitable for medium sized cookings.	When lower section is active, temperature value, rack positions, cooking symbol, stand-by symbol, cooking time symbol and cooking end time symbol of this section appear on the display.
	Lower-upper sections	You can cook simultaneously in lower and upper sections. It is suitable for cooking two different dishes.	When lower-upper sections are active, temperature value, rack positions, cooking symbol, stand-by symbol, cooking time symbol and cooking end time symbol of these sections appear on the display separately.
	Single large section	You can cook in the single large section. It is suitable for large sized and multiple cookings.	When single large section is active, temperature value, rack positions, cooking symbol, stand-by symbol, cooking time symbol and cooking end time symbol of this section appear on the display.

Oven functions





The order of operating modes shown here may be different from the arrangement on your product. These

functions apply to oven with a single large section only.

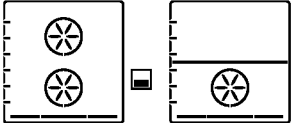
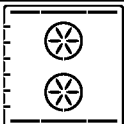
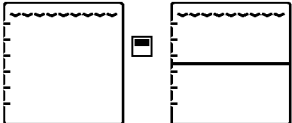
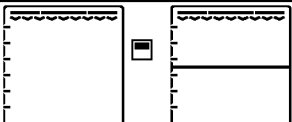
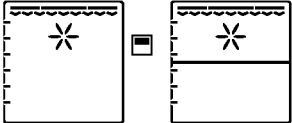
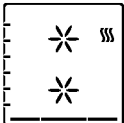
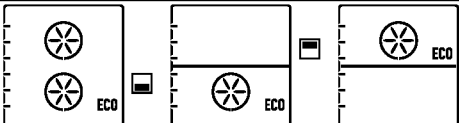
All oven functions of your oven are explained in this section.

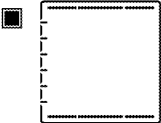







Symbol	Name	Description
	Static (Top and bottom heating)	Top and bottom heaters are in operation simultaneously. Cook with one tray only.
	Bottom heating	Only bottom heater is in operation. It is suitable for pizza and for subsequent browning of food from the bottom.
	Static+fanning (Fan supported bottom/top heating)	Top heater, bottom heater plus fan (in the rear wall) are in operation. Hot air is evenly distributed throughout the oven rapidly by means of the fan. Cook with one tray only.
	Defrost (Fan operated)	The oven is not heated. Only the fan (in the rear wall) is in operation. Suitable for thawing frozen granular food slowly at room temperature and cooling down the cooked food. The time required to thaw a whole piece of meat is longer than the food with grains.
	Fan assisted cooking	Only the fan heater in the rear wall is in operation. Hot air heated by the fan heater is evenly distributed throughout the oven rapidly by means of the fan. In most cases, preheating is not required.
	Top heating+fanning (Fan assisted top heating)	Top heater and the fan heater at the rear wall are in operation. Hot air is distributed better with fan compared to the situation where only top heating is in operation.

Symbol	Name	Description
	Pizza	Bottom heater and the fan assisted heater (at the rear wall) are in operation simultaneously. Suitable for baking pizza.
	Multi "3D" cooking	Top heater, bottom heater and the fan assisted heater are in operation simultaneously. Cook with one tray only.
	Economic grill	Only the inner section of the top heater at oven ceiling operates. Suitable for grilling small and medium sizes of meat.
	Full grill	Inner and outer sections of the top heater at oven ceiling are in operation simultaneously. Suitable for grilling medium size meat pieces.
	Grill + Fan (Fan supported grill)	Rear wall fan operates along with the inner and outer sections of the top heater at oven ceiling. Hot air is evenly distributed throughout the oven rapidly by means of the fan. Suitable for grilling medium size meat pieces.
	Warm keeping	Used for keeping food at a temperature ready for serving for a long period of time. Do not use for cooking food.
	Eco fan cooking	Only the fan heater in the rear wall is in operation. To save power, you can use this function instead of the cooking operations that you would perform by using Fan Heating at 160-220oC temperature range. But, the cooking time will increase a little bit. Cooking times related to this function are indicated in "Eco Fan Cooking" table.

Symbol	Name	Description
	Low temperature cooking	Food is heated simultaneously from the top and bottom. It is suitable for slow-cooking of roasted/seared pieces of meat (veal, lamb, poultry etc.) in an open container at low temperature. This function ensures that the meat is juicy and soft on the inside. Please use hygienically suitable types of meat. On the hob, grill etc., prerost/sear all surfaces of the meat in a hot pan. You can cook the pre-roasted/seared meat with the "low temperature cooking" function for a long time. Cook with one tray only.
Upper section 	Fan heating Economic fan Top heater+fan Full grill+Fan Full grill Defrost Economic grill	Single large section  Static Static+fan Fan heating Multi cooking (3D) Pizza Top heater+fan Full grill+Fan Full grill Economic grill Economic fan Bottom heating Warm keeping Low temperature cooking Defrost
Lower section 	Fan heating Economic fan Defrost Bottom heating Pizza	
Lower-upper section 	Fan assisted+Fan assisted Full grill+Fan assisted Defrost+Defrost Economic grill+Fan assisted Fan assisted+Bottom heater Fan assisted+Pizza	

Function table

Function table indicates the functions that can be used in the oven and their respective maximum and minimum temperatures. Recommended temperature is displayed when the function is selected.

-  Functions vary depending on the product model.
-  While making any adjustment, related symbols will flash on the display.
-  Program will be cancelled in case of power failure. You must reprogram the oven.
-  Current time cannot be set while the oven is operating in any function, or if semi-automatic or full automatic programming is made on the oven.
-  Even if the oven is switched off, oven lamp lights up when the oven door is opened.
-  Due to safety reasons, maximum time that can be set for "Cooking time" is limited with 6 hours at all positions apart from "Warm Keeping" and "Low Temp. Cooking" functions.
-  Due to safety reasons, maximum time that can be set for "Cooking time" is limited with 6 hours at all positions apart from "Warm Keeping" and "Low Temp. Cooking" functions.
-  The oven operates for maximum 2 hours at temperatures 280°C or higher.

Single large section

Function	Temperature range (°C)
Static	40-310
Static + fan	40-280
Fan heating	40-250
Multi cooking (3D)	40-250
Pizza	40-310
Top heater+fan	40-280
Full grill+Fan	40-280
Full grill	40-280
Economic grill	40-280
Economic fan	160-220
Bottom heating	40-220
Warm keeping	40-100
Low temperature cooking	50-150
Defrost	-

Upper section

Function	Temperature range (°C)
Fan heating	40-250
Top heater+fan	40-280
Full grill+Fan	40-280
Full grill	40-280
Economic grill	40-280
Economic fan	160-220
Defrost	-

Lower section

Function	Temperature range (°C)
Fan heating	40-250
Pizza	40-280
Economic fan	160-220
Bottom heating	40-220
Defrost	-

How to operate the oven control unit

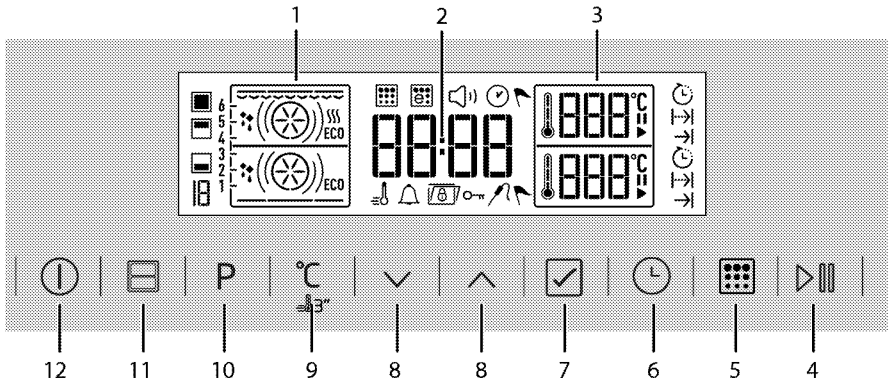

- 1 Function display
 - 2 Current time indicator field
 - 3 Temperature indicator field
 - 4 Start/stop cooking key
 - 5 Pyro key*
 - 6 Time and settings key
 - 7 Confirmation key
 - 8 Up/down keys
 - 9 Temperature/booster setting key
 - 10 Function selection key
 - 11 Oven section selection key
 - 12 ON/OFF key
- * (Varies depending on the product model.)

- Volume setting symbol
- Self cleaning (pyro) symbol*
- Economical self cleaning (ecopyro) symbol*
- Meat probe symbol *
- * Varies depending on the product model.

Operating the oven as a single section

Manual cooking by selecting temperature and operating function

During manual operation, the oven will operate regardless of the cooking time after the function and temperature selection is made. The oven will not switch off automatically at the end of the cooking time. Cooking should be ended by the user.

Oven returns to stand-by display after it is powered on for the first time and the current time is set. Only the current time appears on the display.

1. Remove the middle section plate from the oven. Only after the middle section plate is removed the oven timer will work in single large section cooking setting.
2. Switch on the oven touching the key for two seconds.

Display symbols:

- Rapid heating (Booster) symbol
- Cooking duration symbol
- Cooking duration end symbol*
- Alarm symbol
- Section selection symbol
- Cooking symbol
- Current time symbol
- Stopped symbol
- Keep warm symbol
- Defrost symbol
- Key lock symbol
- Time display symbol

3. When the oven is switched on, the first function particular to the single large section cooking will be displayed.

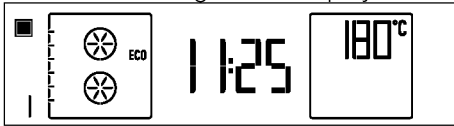

4. Touch **P** to enter the display for setting the operating function.

» The relevant function number will flash on the display.

5. Set the desired cooking function touching the \sim keys. Touch \square to confirm setting.

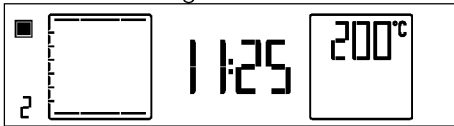

6. If you want to change the temperature, touch $^{\circ}\text{C}$ once to reach the temperature display. $^{\circ}\text{C}$ and \curvearrowright will flash on the display.

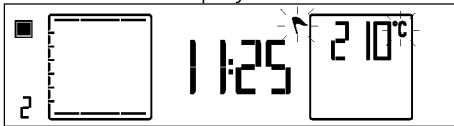

7. Touch \sim to set the desired temperature. When the desired value is reached, touch \square to confirm temperature.

8. For Booster (Rapid Heating), touch $^{\circ}\text{C}$ for approximately 3 seconds until \equiv appears on the display. \equiv will appear and the booster setting will be activated.



i When the booster setting is made, the oven operates in maximum power to reach the set temperature. When the set temperature is reached \equiv will disappear. Booster setting is active for the functions during which \equiv is displayed when $^{\circ}\text{C}$ is touched for a long time. Booster can only be activated for cooking operations performed in the single large section.

9. Put your dish into the oven and close the door.

10. If cooking function and temperature values are suitable, touch \triangleright for two seconds to start cooking. Cooking will start and \blacktriangleright will appear on the display.



» Oven will heat up to the adjusted temperature.

i All segments of the inner oven temperature symbol \downarrow will turn on when the oven reaches the set temperature.

11. When the cooking process is completed touch \triangleright key again for two seconds to end the cooking.

Cooking by setting the cooking time;

You can make your oven switch off automatically at the end of cooking time by selecting the temperature and function specific to your meal and setting the cooking time.

Oven returns to stand-by display after it is powered on for the first time and the current time is set. Only the current time appears on the display.

1. Remove the middle section plate from the oven. Only after the middle section plate is removed the oven timer will work in single large section cooking setting.
2. Switch on the oven touching the  key for two seconds.
3. When the oven is switched on, the first function particular to the single large section cooking will be displayed.

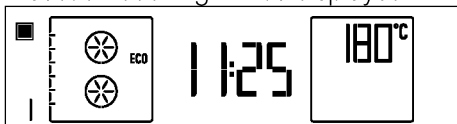



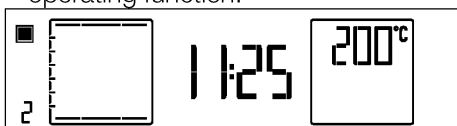

4. Touch **P** to enter the display for setting the operating function.
» The relevant function number will flash on the display.
5. Touch  to set the desired operating function.

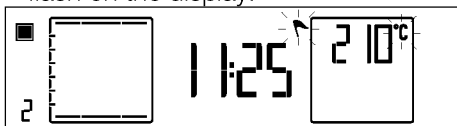





6. If you want to change the temperature, touch **°C** once to reach the temperature display. **°C** symbol will flash on the display.

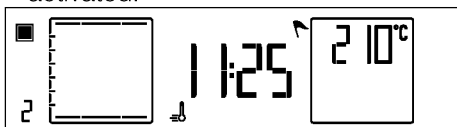







7. Touch  to set the desired temperature. When the desired value is reached, touch  to confirm temperature.
8. For Booster (Rapid Heating), touch **°C** for approximately 3 seconds until  appears on the display.  will appear and the booster setting will be activated.

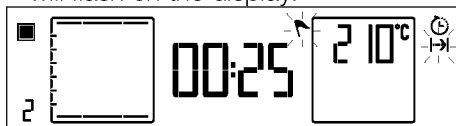

- i** When the booster setting is made, the oven operates in maximum power to reach the set temperature. When the set temperature is reached  will disappear. Booster setting is active for the functions during which  is displayed when **°C** is touched for a long time. Booster can only be activated for cooking operations performed in the single large section.

9. Touch  once for cooking time.  will flash on the display.





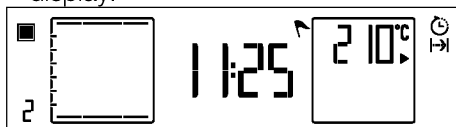

10. Touch  to set the desired cooking time and confirm the setting by touching . Once the cooking time is set,  and  will remain lit on the display.
11. Put your dish into the oven and close the door.
12. If cooking function, temperature and time values are suitable, touch  for 2 seconds to start cooking. Cooking will start and  will appear on the display.



- » Your oven will readily start operating in the selected function and will increase the inner temperature to the set temperature. It maintains this temperature until the end of the set cooking time. Each grade of the inner temperature symbol will be lit as inner temperature reaches to the set temperature. Additional active heaters

and recommended tray position appear in the Function display.

i All segments of the inner oven temperature symbol  will turn on when the oven reaches the set temperature.

13. After the cooking is completed,  and  will flash on the display and an alarm signal will be heard.
14. To stop the alarm signal, just touch any key. The oven will switch off automatically.
15. If you want the oven to continue operating, press  for 2 seconds. The oven will continue cooking for an indefinite period of time.

i If you want to cancel the setting after performing the cooking setting by adjusting the cooking time, you will need to reset the cooking time. You can also switch off the oven by touching  if you want.

Setting the end of cooking time to a later time; (This feature is optional. It may not exist on your product.)



You can ensure that the oven runs and turns off automatically by setting temperature and operating function specific to your meal, the cooking time and end of cooking to a later time, manually controlling without setting the cooking time.

Oven returns to stand-by display after it is powered on for the first time and the current time is set. Only the current time appears on the display.

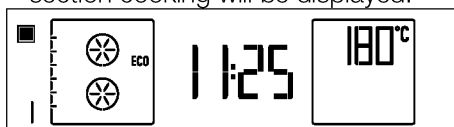

1. Remove the middle section plate from the oven. Only after the middle section plate is removed the oven timer will work in single large section cooking setting.

2. Switch on the oven touching the  key for two seconds.
3. When the oven is switched on, the first function particular to the single large section cooking will be displayed.



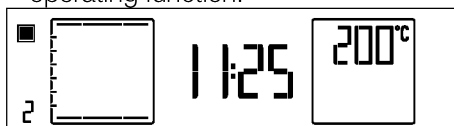



4. Touch  to enter the display for setting the operating function.
» The relevant function number will flash on the display.
5. Touch  to set the desired operating function.

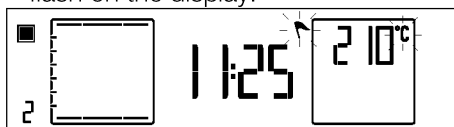

6. If you want to change the temperature, touch  once to reach the temperature display.  symbol will flash on the display.



7. Touch  to set the desired temperature. When the desired value is reached, touch  to confirm temperature.
8. For Booster (Rapid Heating), touch  for approximately 3 seconds until  appears on the display.  will appear and the booster setting will be activated.

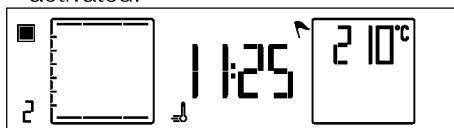

i When the booster setting is made, the oven operates in maximum power to reach the set temperature. When the set temperature is reached \equiv will disappear. Booster setting is active for the functions during which \equiv is displayed when $^{\circ}\text{C}$ is touched for a long time. Booster can only be activated for cooking operations performed in the single large section.

9. Touch \odot once for cooking time. \rightarrow will flash on the display.



10. Touch \wedge/\vee to set the desired cooking time and confirm the setting by touching \square . Once the cooking time is set, \rightarrow and \odot will remain lit on the display.

11. Touch \odot twice at short intervals for the end of cooking time. \rightarrow will flash on the display.



12. Touch \wedge/\vee to set the desired end of cooking time and confirm the setting by touching \square . Once the end of cooking time is set, \rightarrow will be displayed continuously.

13. Put your dish into the oven and close the door.

14. If cooking function, temperature, time and end time values are suitable, touch \triangleright for 2 seconds to start cooking.



\gg will appear on the display. Oven timer automatically calculates the startup time for cooking by deducting the cooking time from the end of cooking time you have set. When the cooking startup time comes, the selected cooking function will be activated, \rightarrow will disappear and the oven will heat up to the set temperature. It will maintain this temperature until the end of the set cooking time. Each grade of the inner temperature symbol will be lit as inner temperature reaches to the set temperature. Additional active heaters and recommended tray position appear in the Function display. The oven lamp is lit during the cooking process.

i All segments of the inner oven temperature symbol \downarrow will turn on when the oven reaches the set temperature.

15. After the cooking is completed, \rightarrow and \rightarrow will flash on the display and an alarm signal will be heard.

16. To stop the alarm signal, just touch any key. The oven will switch off automatically.

17. If you want the oven to continue operating, press \triangleright for 2 seconds. The oven will continue cooking for an indefinite period of time.

i If you want to cancel the programme after performing the cooking setting by adjusting the cooking time, you will need to reset the cooking time. You can also switch off the oven by touching \odot if you want.

Using the oven only as the top or bottom section

Manual cooking by selecting temperature and operating function

During manual operation, the oven will operate regardless of the cooking time after the function and temperature selection is made. The oven will not switch off automatically at the end of the cooking time. Cooking should be ended by the user.

Oven returns to stand-by display after it is powered on for the first time and the current time is set. Only the current time appears on the display.

1. Place the middle section plate in its housing found between the 3rd and 4th rack guides.

i If the middle section plate is not placed, the oven timer will operate as a whole single section.

2. Switch on the oven touching the  key for two seconds.
3. When the oven is switched on, the first function special to the top section cooking will be displayed.

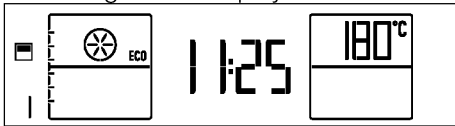

4. Touch  once to activate the bottom section of oven.

Temperature setting and cooking process initiation steps for both bottom and top oven sections will operate in the same way. (In the images, the bottom oven is shown as selected.)

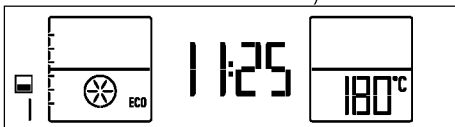





i Each time you touch , the bottom section only, both bottom and top sections and the top section only will be activated respectively.

5. Touch **P** to enter the display for setting the operating function.
» The relevant function number will flash on the display.
6. Touch  to set the desired operating function.



7. If you want to change the temperature, touch **°C** once to reach the temperature display. **°C** symbol will flash on the display.



8. Touch  to set the desired temperature. When the desired value is reached, touch  to confirm temperature.
9. Put your dish into the oven and close the door.
10. If cooking function and temperature values are suitable, touch  for two seconds to start cooking. Cooking will start and  will appear on the display.

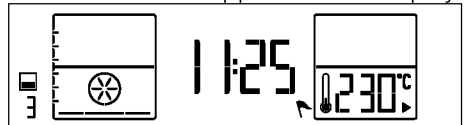

» Oven will heat up to the adjusted temperature.

i All segments of the inner oven temperature symbol  will turn on when the oven reaches the set temperature.

11. When the cooking process is completed touch  key again for two seconds to end the cooking.

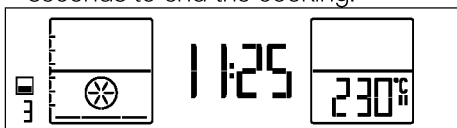

- i** When using only the top or bottom section for cooking, keep the unused section empty as it will get hot.

Cooking by setting the cooking time;

You can make your oven switch off automatically at the end of cooking time by selecting the temperature and function specific to your meal and setting the cooking time.

Oven returns to stand-by display after it is powered on for the first time and the current time is set. Only the current time appears on the display.

1. Place the middle section plate in its housing found between the 3rd and 4th rack guides.

- i** If the middle section plate is not placed, the oven timer will operate as a whole single section.

2. Switch on the oven touching the  key for two seconds.
3. When the oven is switched on, the first function special to the top section cooking will be displayed.

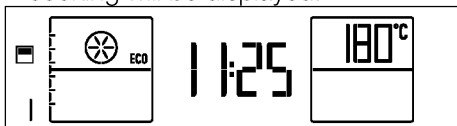

4. Touch  once to activate the bottom section of oven.

Temperature setting and cooking process initiation steps for both bottom and top oven sections will iterate in the same way. (In the images, the bottom oven is shown as selected.)

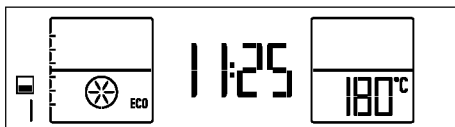

- i** Each time you touch , the bottom section only, both bottom and top sections and the top section only will be activated respectively.

5. Touch **P** to enter the display for setting the operating function.



» The relevant function number will flash on the display.

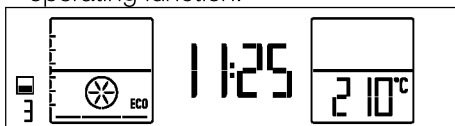

6. Touch  to set the desired operating function.







7. If you want to change the temperature, touch **°C** once to reach the temperature display. **°C** symbol will flash on the display.

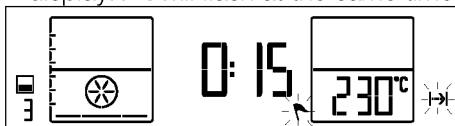

8. Touch  to set the desired temperature. When the desired value is reached, touch  to confirm temperature.

9. For cooking time, press  once to scroll to the "Cooking time" on the text display.  will flash at the same time.



10. Touch  to set the desired cooking time and confirm the setting by touching . Once the cooking time is set,  and  will remain lit on the display.

11. Put your dish into the oven and close the door.

12. If cooking function, temperature and time values are suitable, touch \triangleright for 2 seconds to start cooking. Cooking will start and \blacktriangleright will appear on the display.

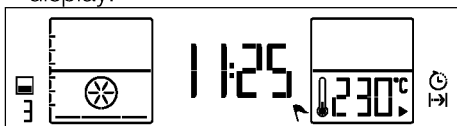

» Your oven will readily start operating in the selected function and will increase the inner temperature to the set temperature. It will maintain this temperature until the end of the set cooking time. Each grade of the inner temperature symbol will be lit as inner temperature reaches to the set temperature. Additional active heaters and recommended tray position appear in the Function display.

i All segments of the inner oven temperature symbol will turn on when the oven reaches the set temperature.

13. After the cooking is completed, \blacktriangleleft and \rightarrow will flash on the display and an alarm signal will be heard.

14. To stop the alarm signal, just touch any key. The oven will switch off automatically.

15. If you want the oven to continue operating, press \triangleright for 2 seconds. The oven will continue cooking for an indefinite period of time.

i If you want to cancel the setting after performing the cooking setting by adjusting the cooking time, you will need to reset the cooking time. You can also switch off the oven by touching ⓪ if you want.

Setting the end of cooking time to a later time; (This feature is optional. It may not exist on your product.)

You can ensure that the oven runs and turns off automatically by setting temperature and operating function specific to your meal, the cooking time and end of cooking to a later time, manually controlling without setting the cooking time.

Oven returns to stand-by display after it is powered on for the first time and the current time is set. Only the current time appears on the display.

1. Place the middle section plate in its housing found between the 3rd and 4th rack guides.

i If the middle section plate is not placed, the oven timer will operate as a whole single section.

2. Switch on the oven touching the ⓪ key for two seconds.

3. When the oven is switched on, the first function special to the top section cooking will be displayed.

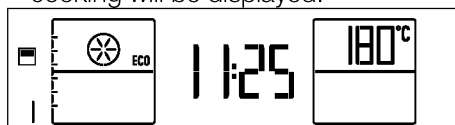

4. Touch ⓪ once to activate the bottom section of oven.

\blacktriangleleft will appear next to the active oven section. Temperature setting and cooking process initiation steps for both bottom and top oven sections will iterate in the same way. (In the images, the bottom oven is shown as selected.)



i Each time you touch , the bottom section only, both bottom and top sections and the top section only will be activated respectively.

5. Touch **P** to enter the display for setting the operating function.



» The relevant function number will flash on the display.



6. Touch  to set the desired operating function.







7. If you want to change the temperature, touch **°C** once to reach the temperature display. **°C** symbol will flash on the display.



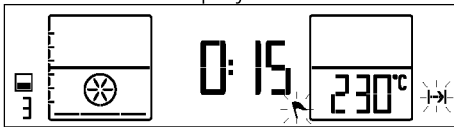

8. Touch  to set the desired temperature. When the desired value is reached, touch  to confirm temperature.



9. Touch  once for cooking time.  will flash on the display.



10. Touch  to set the desired cooking time and confirm the setting by touching . Once the cooking time is set,  will be displayed continuously.

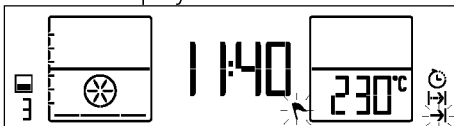

11. Touch  twice at short intervals for the end of cooking time.  will flash on the display.





12. Touch  to set the desired end of cooking time and confirm the setting by touching . Once the end of cooking time is set,  will be displayed continuously.

13. Put your dish into the oven and close the door.

14. If cooking function, temperature, time and end time values are suitable, touch  for 2 seconds to start cooking.

»  will appear on the display. Oven timer automatically calculates the startup time for cooking by deducting the cooking time from the end of cooking time you have set. When the cooking startup time comes, the selected cooking function will be activated,  will disappear and the oven will heat up to the set temperature. It will maintain this temperature until the end of the set cooking time. Each grade of the inner temperature symbol will be lit as inner temperature reaches to the set temperature. Additional active heaters and recommended tray position appear in the Function display. The oven lamp is lit during the cooking process.

i All segments of the inner oven temperature symbol  will turn on when the oven reaches the set temperature.

15. After the cooking is completed,  and  will flash on the display and an alarm signal will be heard.

16. To stop the alarm signal, just touch any key. The oven will switch off automatically.

17. If you want the oven to continue operating, press  for 2 seconds. The oven will continue cooking for an indefinite period of time.

- i** If you want to cancel the programme after performing the cooking setting by adjusting the cooking time, you will need to reset the cooking time. You can also switch off the oven by touching  if you want.

Using the top and bottom sections of the oven simultaneously

Manual cooking by selecting temperature and operating function

During manual operation, the oven will operate regardless of the cooking time after the function and temperature selection is made. The oven will not switch off automatically at the end of the cooking time. Cooking should be ended by the user.

Oven returns to stand-by display after it is powered on for the first time and the current time is set. Only the current time appears on the display.

1. Place the middle section plate in its housing found between the 3rd and 4th rack guides.

- i** If the middle section plate is not placed, the oven timer will operate as a whole single section.

2. Switch on the oven touching the  key for two seconds.
3. When the oven is switched on, the first function special to the top section cooking will be displayed.

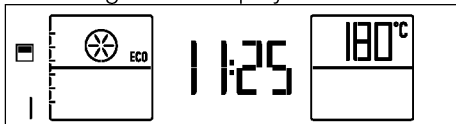

- i** Each time you touch , the bottom section only, both bottom and top sections and the top section only will be activated respectively.

4. Activate both sections by touching  twice.

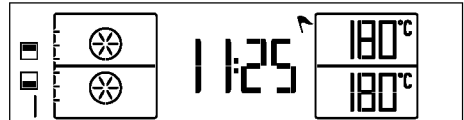



5. Touch **P** to enter the display for setting the operating function.



» The relevant function number will flash on the display.

6. Touch the  to select the appropriate cooking function amongst the ones adjusted for both oven sections. For example, to make grill in the top and cook pastry in the bottom section you can select Grill & Fan supported function.



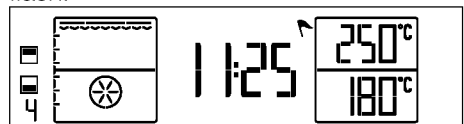

After the function is selected,

"Temperature" and "Cooking time" can be adjusted separately for each oven section.  and  symbols of the active cooking sections for this settings will flash.

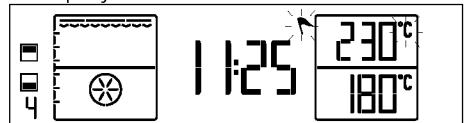

7. If you want to change the temperature of top oven, touch  once to access the temperature display of top oven.  and  will flash on the temperature display of the selected oven section.









8. Touch  to set the desired temperature. When you reach the desired value, confirm the temperature by touching .  will lid steadily and  symbol of the active cooking section will flash.

9. To change the temperature of the bottom oven, activate the bottom

oven's temperature display touching . Bottom oven's  symbol will flash.





10. Touch  once to access the temperature display of bottom oven.  and  will flash on the temperature display of the selected oven section.

11. Touch  to set the desired temperature. When you reach the desired value, confirm the temperature by touching .  will lid steadily and  symbol of the active cooking section will flash.

i While using the top and bottom sections simultaneously, if you want to change temperature setting, the difference between the sections cannot be more than 80 °C. Because the sections will be affected from each others temperature.

12. Put your dish into the oven and close the door.

13. If cooking function and temperature values are suitable, touch  for two seconds to start cooking. Cooking will start and  and  will appear on the display of the top and bottom oven sections.

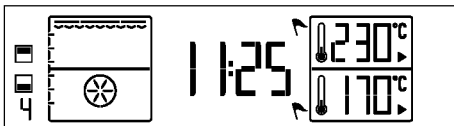

i All segments of the inner oven temperature symbol  will turn on when the oven reaches the set temperature.

14. When the cooking process is completed touch  key again for two seconds to end the cooking.



Cooking by setting the cooking time;

Semi-automatic operation

You can make your oven switch off automatically at the end of cooking time by selecting the temperature and function specific to your meal and setting the cooking time.

Oven returns to stand-by display after it is powered on for the first time and the current time is set. Only the current time appears on the display.

1. Place the middle section plate in its housing found between the 3rd and 4th rack guides.



i If the middle section plate is not placed, the oven timer will operate as a whole single section.

2. Switch on the oven touching the  key for two seconds.

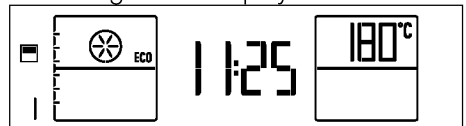
3. When the oven is switched on, the first function special to the top section cooking will be displayed.



i Each time you touch , the bottom section only, both bottom and top sections and the top section only will be activated respectively.

4. Activate both sections by touching  twice.  will appear next to each oven section.

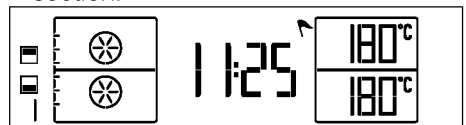

5. Touch **P** to enter the display for setting the operating function.

» The relevant function number will flash on the display.



6. Touch  to select the appropriate cooking function amongst the ones adjusted for both oven sections. For example, to make grill in the top and cook pastry in the bottom section you can select Grill & Fan supported function.

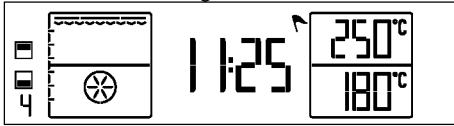

After the function is selected, **"Temperature"** and **"Cooking time"** can be adjusted separately for each oven section. For these settings  symbol of the active cooking section will flash.

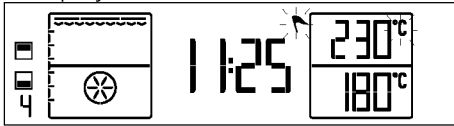

7. If you want to change the temperature of top oven, touch **°C** once to access the temperature display of top oven. **°C** symbol will flash on the temperature display of the selected oven section.





8. Touch  to set the desired temperature. When you reach the desired value, confirm the temperature by touching . **°C** will lid steadily and  symbol of the active cooking section will flash.



9. To change the temperature of the bottom oven, activate the bottom oven's temperature display by touching . Bottom oven's  symbol will flash.





10. Touch **°C** once to access the temperature display of bottom oven. **°C** symbol will flash on the temperature display of the selected oven section.





11. Touch  to set the desired temperature. When you reach the desired value, confirm the temperature by touching . **°C** will lid steadily and  symbol of the active cooking section will flash.

i While using the top and bottom sections simultaneously, if you want to change temperature setting, the difference between the sections cannot be more than 80 °C. Because the sections will be affected from each others temperature.



12. Touch  once for the cooking time of the active bottom section of the oven. At the same time,  will flash.



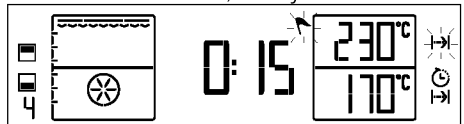

13. Touch  to set the desired cooking time and confirm the setting by touching . Once the cooking time is set,  will be displayed on the screen continuously.

14. For the cooking time of the other top section, first activate the section by touching .  symbol of the top section will flash. Then, touch  once. At the same time,  symbols will flash.







15. Set the desired cooking time for the top section by touching  and confirm with . Once the cooking time of the top section is set,  will be displayed on the screen continuously.



16. Put your dish into the oven and close the door.

17. If cooking function, temperature and time values are suitable, touch  for 2 seconds to start cooking. Cooking will start and  will appear on the display.



» Your oven will readily start operating in the selected function and will increase the inner temperature to the set temperature. It will maintain this temperature until the end of the set cooking time. Each grade of the inner temperature symbol will be lit as inner temperature reaches to the set temperature. Additional active heaters and recommended tray position appear in the Function display.

 All segments of the inner oven temperature symbol  will turn on when the oven reaches the set temperature.

18. At the end of the short cooking time, a single signal will be heard and  and  symbols of the related oven section will disappear.



After the cooking is completed,  and  will flash on the display and an alarm signal will be heard.

19. Take the meal out of the oven when cooking duration is over. When you close the oven door again, cooking in the other section with the longer cooking duration will continue.

20. Once the long cooking duration is complete, two signals will be heard and  and  symbols of the related oven section will flash.

21. Cooking will stop.

22. Touch  for two seconds if you want both sections of the oven to continue operating. The oven will continue cooking for an indefinite period of time.

 If you want to cancel the semi-automatic programming after you have set it, you need to reset the cooking duration. You can also switch off the oven by touching  for 2 seconds if you want.

Switching off the electric oven

Touch  for 2 seconds to switch off the oven.

Using the key lock

You can prevent oven from being intervened with by activating the key lock function.



 Key lock can be used when the oven is in stand-by. The set key lock will be cancelled in case of power failure.

Activating the key lock

1. Touch  key with short intervals until "OFF" appears on the display.



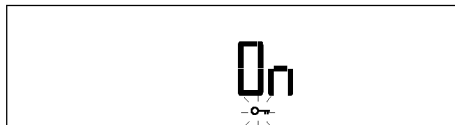

»  will flash.

2. Touch  key once to activate the key lock. The key lock will be activated, "On" will appear on the display.  will continue to flash.



3. Touch  to confirm the setting.

» The text will disappear and  will light continuously.

 Except for   keys, other oven keys are not functional when the key lock function is activated.

Deactivating the key lock

1. Touch  once to deactivate the key lock. "OFF" will appear on the display.

2. Touch  to confirm the setting.



» Key lock will be deactivated and  on the display will disappear.



Using the clock as an alarm

You can use the timer of the product for any warning or reminder apart from the cooking program.



The alarm clock has no influence on the functions of the oven. It is only used as a warning. For example, this is useful when you want to turn food in the oven at a certain point of time. Alarm clock will give a signal once the time you set is over.

 Maximum alarm time can be 23 hours and 59 minutes.



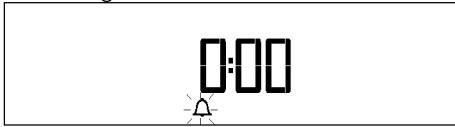

To set the alarm:

1. Touch  at short intervals until  appears on the display.  will start flashing.





2. Touch  to set the desired time and confirm the setting by touching . Once the alarm time is set,  will be displayed continuously.
3. Alarm will be given after the alarm time has elapsed.
4. You can stop the alarm by touching any key.

To cancel the alarm:

1. Touch  key at short intervals until  appears on the display.
 2. Touch  until "00:00" appears on the display and confirm the setting by touching .
- » Alarm will be cancelled and  symbol will disappear.

Sound setting

Sound can only be set when the oven is on stand-by display.

1. Touch  key at short intervals until  appears on the display.  will flash on the display.

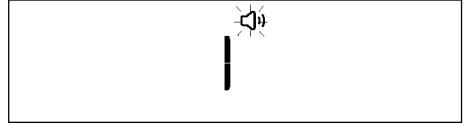

2. There are 2 sound types, namely "1" and "2". Touch  to select the desired type.

3. Touch  to confirm the setting.

» It returns to the stand-by display. Only the current time appears on the display.

Current time setting

Current time can only be set when the oven is switched off. If you want to change the time that was set during initial setup:

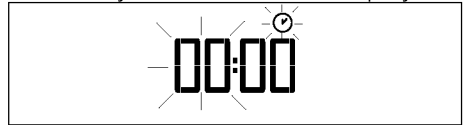

1. Touch  key at short intervals until  appears on the display. Hour field and  will symbol flash on the display.



2. Use  to set the hour field.

3. Touch  to confirm the setting.

4. Minute field and  symbol will flash.

Set the minute with  keys. Touch  to confirm the minute.

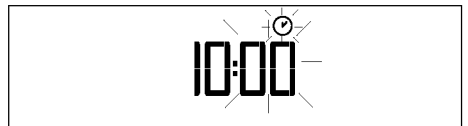

» It returns to the stand-by display. Only the current time appears on the display.



















Cooking times table



i The timings in this chart are meant as a guide. Timings may vary due to temperature of food, thickness, type and your own preference of cooking.

For single large section Baking and roasting

i When you open the oven door, if there are cooking tips available on the glass of the oven door these are applicable for the single whole section.

i 1st rack of the oven is the **bottom** rack.

Dish	Cooking level number	Accessory to use	Operating mode	Rack position	Temperature (°C)	Cooking time (approx. in min.)
Cakes in tray	One level	Standard tray*		3	175	25 ... 35
Cakes in mould	One level	Cake mold on wire grill**		2	180	40 ... 50
Small cakes	One level	Standard tray*		3	160	20 ... 30
	One level	Standard tray*		3	150	25 ... 35
	2 levels	1-Deep tray* 5-Standard tray*		1 - 5	150	25 ... 35
	3 levels	1-Deep tray* 3-Standard tray* 5-Pastry tray*		1 - 3 - 5	150	30 ... 45
Sponge cake	One level	Round springform pan with a diameter of 26 cm on wire grill**		3	160	25 ... 35
	One level	Round springform pan with a diameter of 26 cm on wire grill**		2	150	30 ... 40
	2 levels	1-Round springform pan with a diameter of 26 cm on wire grill** 4-Round springform pan with a diameter of 26 cm on pastry tray**		1 - 4	150	25 ... 35
Cookies	One level	Pastry tray*		3	175	25 ... 30
	2 levels	1-Pastry tray* 5-Standard tray*		1 - 5	170 ... 190	30 ... 40
	3 levels	1-Pastry tray* 3-Standard tray* 5-Deep tray*		1 - 3 - 5	175	35 ... 45
Dough pastry	One level	Standard tray*		2	200	30 ... 40
	2 levels	1-Pastry tray* 5-Standard tray*		1 - 5	200	45 ... 55
	3 levels	1-Pastry tray* 3-Standard tray* 5-Deep tray*		1 - 3 - 5	200	55 ... 65
Rich pastry	One level	Standard tray*		2	200	25 ... 35
	2 levels	1-Pastry tray* 5-Standard tray*		1 - 5	200	35 ... 45
	3 levels	1-Pastry tray* 3-Standard tray* 5-Deep tray*		1 - 3 - 5	190	45 ... 55

Dish	Cooking level number	Accessory to use	Operating mode	Rack position	Temperature (°C)	Cooking time (approx. in min.)
Leaven	One level	Standard tray*		2	200	35 ... 45
	2 levels	1-Standard tray* 3-Pastry tray*		1 - 3	190	35 ... 45
Lasagna	One level	Glass/metal rectangular pan on wire grill**		2 - 3	200	30 ... 40
Pizza	One level	Standard tray*		2	200 ... 220	15 ... 20
	One level	Standard tray*		3	200	10 ... 15
Beef steak (whole) / Roast	One level	Standard tray*		3	25 min. 250/max then 180 ... 190	100 ... 120
Leg of Lamb (casserole)	One level	Standard tray*		3	25 min. 250/max then 190	70 ... 90
	One level	Standard tray*		3	25 min. 250/max then 190	70 ... 90
Roasted chicken (1.8-2 kg)	One level	Standard tray*		2	15 min. 250/max then 180 ... 190	60 ... 80
	One level	Standard tray*		2	15 min. 250/max then 180 ... 190	60 ... 80
Turkey (5.5 kg)	One level	Standard tray*		1	25 min. 250/max then 180 ... 190	150 ... 210
	One level	Standard tray*		1	25 min. 250/max then 180 ... 190	150 ... 210
Fish	One level	Standard tray*		3	200	20 ... 30
	One level	Standard tray*		3	200	20 ... 30











It is suggested to perform preheating for all foods.

* These accessories may not be supplied with the product.

** These accessories are not supplied with the product. They are commercially available accessories.

For bottom section only Baking and roasting







i Foods given only in the bottom section cooking table and only in the top section cooking table can be cooked at the same time in 2 separate volumes. However, the temperature difference between the two section cannot be adjusted greater than 80 °C.

Dish	Cooking level number	Accessory to use	Operating mode	Rack position	Temperature (°C)	Cooking time (approx. in min.)
Cakes in mould	One level	Cake mold on wire grill**		1	175	40 ... 50
Small cakes	One level	Standard tray*		2	150	35 ... 45
	2 levels	1-Deep tray* 3-Standard tray*		1 - 3	150	35 ... 45
Sponge cake	One level	Round springform pan with a diameter of 26 cm on wire grill**		1	150	25 ... 35
Cookies	One level	Pastry tray*		2	170 ... 180	35 ... 45
	2 levels	1-Pastry tray* 3-Standard tray*		1 - 3	165	35 ... 40
Rich pastry	One level	Standard tray*		2	190	35 ... 45
Pizza	One level	Standard tray*		1	200	10 ... 15
Roasted chicken (1.8-2 kg)	One level	Standard tray*		1	15 min. 250/max then 180 ... 190	60 ... 80
Turkey (Sliced)	One level	Standard tray*		1	25 min. 250/max then 180 ... 190	150 ... 210
Fish	One level	Standard tray*		2	200	20 ... 30

It is suggested to perform preheating for all foods.
 * These accessories may not be supplied with the product.
 ** These accessories are not supplied with the product. They are commercially available accessories.

For top section only Baking and roasting

i Foods given only in the bottom section cooking table and only in the top section cooking table can be cooked at the same time in 2 separate volumes. However, the temperature difference between the two section cannot be adjusted greater than 80 °C.











Dish	Cooking level number	Accessory to use	Operating mode	Rack position	Temperature (°C)	Cooking time (approx. in min.)
Cakes in mould	One level	Cake mold on wire grill**		4	175	40 ... 50
Small cakes	One level	Standard tray*		5	150	25 ... 40
Cookies	One level	Pastry tray*		4	170 ... 180	35 ... 45
Rich pastry	One level	Standard tray*		4	190	35 ... 45
Roasted chicken (1.8-2 kg)	One level	Standard tray*		4	15 min. 250/max then 180 ... 190	60 ... 80
Turkey (Sliced)	One level	Standard tray*		4	25 min. 250/max then 180 ... 190	150 ... 210
Fish	One level	Standard tray*		5	200	20 ... 30

It is suggested to perform preheating for all foods.

* These accessories may not be supplied with the product.

** These accessories are not supplied with the product. They are commercially available accessories.

Baking pizza at high temperature

Dish	Cooking level number	Accessory to use	Operating mode	Rack position	Temperature (°C)	Cooking time (approx. in min.)
Diet pizza*	One level	Pizza stone**		2	310	3 ... 4
Sausage pizza a la Rome	One level	Pizza stone**		2	310	4 ... 5
Two fold pizza*	One level	Pizza stone**		2	310	3 ... 4
Calzone*	One level	Pizza stone**		2	260	10 ... 11
Turkish Pizza	One level	Pizza stone**		1	310	4 ... 5
Turkish pita with ground meat*	One level	Pizza stone**		2	260	10 ... 12
Pizza napoli*	One level	Pizza stone**		2	310	4 ... 5
Pizza margherita*	One level	Pizza stone*		2	310	4 ... 5
Turkish pita with cheddar and pastrami	One level	Pizza stone**		1	300	5 ... 6
Mixed pizza*	One level	Pizza stone**		2	310	4 ... 5

* It is suggested to perform preheating for all foods.

** These accessories may not be supplied with the product.

Eco Fan Heating

i Do not change the cooking temperature after cooking starts in Eco Fan Heating mode.

i Do not open the door during cooking in the Eco Fan Heating mode.

Dish	Cooking level number	Accessory to use	Rack position	Temperature (°C)	Cooking time (approx. in min.)
Small cakes	One level	Standard tray*	3	160	25 ... 35
Cookies	One level	Standard tray*	3	200	30 ... 35
Dough pastry	One level	Standard tray*	3	200	40 ... 45
Rich pastry	One level	Standard tray*	3	200	40 ... 45













* These accessories may not be supplied with the product.

Cooking table for test meals (for single large section)

Meals in this cooking table are prepared according to EN 60350-1 to make it

easier for control institutes to test the product.

i 1st rack of the oven is the **bottom** rack.

Dish	Cooking level number	Accessory to use	Operating mode	Rack position	Temperature (°C)	Cooking time (approx. in min.)
Shortbread	One level	Standard tray*		3	140	20 ... 30
	One level	Standard tray*		3	140	20 ... 30
	2 levels	1-Standard tray* 3-Pastry tray*		1 - 3	140	20 ... 30
	3 levels	1-Standard tray* 3-Pastry tray* 5-Deep tray*		1 - 3 - 5	140	25 ... 35
Small cakes	One level	Standard tray*		3	160	20 ... 30
	One level	Standard tray*		3	150	25 ... 35
	2 levels	1-Deep tray* 5-Standard tray*		1 - 5	150	25 ... 35
	3 levels	1-Deep tray* 3-Standard tray* 5-Pastry tray*		1 - 3 - 5	150	30 ... 45
Sponge cake	One level	Round springform pan with a diameter of 26 cm on wire grill**		3	160	25 ... 35
	One level	Round springform pan with a diameter of 26 cm on wire grill**		2	150	30 ... 40
	2 levels	1-Round springform pan with a diameter of 26 cm on wire grill** 4-Round springform pan with a diameter of 26 cm on pastry tray**		1 - 4	150	25 ... 35
Apple pie	One level	Round black metal dish with a diameter of 20 cm on wire grill**		2	180	55 ... 65
	One level	Round black metal dish with a diameter of 20 cm on wire grill**		3	180	50 ... 60

Dish	Cooking level number	Accessory to use	Operating mode	Rack position	Temperature (°C)	Cooking time (approx. in min.)
	2 levels	1-Round black metal dish with a diameter of 20 cm on wire grill** 3-Round black metal dish with a diameter of 20 cm on pastry tray**		1 - 3	180	55 ... 65
<p>It is suggested to perform preheating for all foods. * These accessories may not be supplied with the product. ** These accessories are not supplied with the product. They are commercially available accessories.</p>						

Tips for baking cake

- If the cake is too dry, increase the temperature some 10°C and decrease the cooking time.
- If the cake is wet, use less liquid or lower the temperature by 10°C.
- If the cake is too dark on top, place it on a lower rack, lower the temperature and increase the cooking time.
- If cooked well on the inside but sticky on the outside use less liquid, lower the temperature and increase the cooking time.

Tips for baking pastry

- If the pastry is too dry, increase the temperature some 10°C and decrease the cooking time. Dampen the layers of dough with a sauce composed of milk, oil, egg and yoghurt.
- If the pastry takes too long to bake, pay care that the thickness of the pastry you have prepared does not exceed the depth of the tray.
- If the upper side of the pastry gets browned, but the lower part is not cooked, make sure that the amount of sauce you have used for the pastry is not too much at the bottom of the pastry. Try to scatter the sauce equally between the dough layers and on the top of pastry for an even browning.

 Cook the pastry in accordance with the mode and temperature given in the cooking table. If the bottom part is still not browned enough, place it on one lower rack next time.

Tips for cooking vegetables

- If the vegetable dish runs out of juice and gets too dry, cook it in a pan with a lid instead of a tray. Closed vessels will preserve the juice of the dish.
- If a vegetable dish does not get cooked, boil the vegetables beforehand or prepare them like canned food and put in the oven.

Pizza menu recipes

SAUSAGE PIZZA A LA ROME INGREDIENTS

For the dough:

- 300 g tepid drinking water (40°C)
- 1 tablespoon olive oil
- 20 g fresh yeast
- 20 g granulated sugar
- 500 g flour
- 15 g salt

For the sauce:

- 6 tomatoes
- 2 tablespoons tomato paste
- 2 tablespoons olive oil
- 2 teaspoons salt

For the toppings:

- 400 g grated mozzarella
- 400 g sausage
- 4 dessert spoon dry thyme

- Olive oil

PREPARATION

- Mix water, olive oil, yeast and granulated sugar in a pot.
- Pour flour in a separate pot and make a well in the center.
- Pour the liquid mixture into the well and knead for 10 minutes.
- Add salt and knead for 3-4 more minutes.
- Grease a contained with 1 tablespoon olive oil, place the dough you prepared into this container and cover with aluminum foil.
- Ferment the dough you prepared for 1 day in the fridge.
- Divide the dough into 4 equal pieces and roll each of them.
- Dust a large pot with flour, place the rounded dough into the pot and rest them for half an hour after covering with damp cloth.
- Grate the tomatoes and mix all ingredients for the sauce in a separate pot.
- Cut the sausages for the topping into rings.
- Spread the dough thinly with a rolling pin.
- Smear tomato sauce on the rolled dough, then add some of the mozzarella and the sausages.
- Add the rest of mozzarella and dry thyme on sausages and pour olive oil, then bake the pizza.

•

 Notice: The recipe is for 4 pizzas.

TWO FOLD PIZZA

INGREDIENTS

For the dough:

- 300 g tepid drinking water (40°C)
- 1 tablespoon olive oil
- 20 g fresh yeast

- 20 g granulated sugar
- 500 g flour
- 15 g salt

For the toppings:

- 200 g arugula
- 240 g parmesan cheese
- Olive oil

PREPARATION

- Mix water, olive oil, yeast and granulated sugar in a pot.
- Pour flour in a separate pot and make a well in the center.
- Pour the liquid mixture into the well and knead for 10 minutes.
- Add salt and knead for 3-4 more minutes.
- Grease a contained with 1 tablespoon olive oil, place the dough you prepared into this container and cover with aluminum foil.
- Ferment the dough you prepared for 1 day in the fridge.
- Divide the dough into 8 equal pieces and roll each of them.
- Dust a large pot with flour, place the rounded dough into the pot and rest them for half an hour after covering with damp cloth.
- Spread the dough thinly with a rolling pin.
- Bore holes in the dough with a fork in order to prevent leavening. Take care that there are enough holes all over the dough.
- Bake the doughs one by one.
- Put parmesan cheese between the two baked doughs. Put parmesan cheese, arugula and olive oil on top, then serve.

 Notice: The recipe is for 4 pizzas.

CALZONE

INGREDIENTS

For the dough:

- 300 g tepid drinking water (40°C)
- 1 tablespoon olive oil
- 20 g fresh yeast
- 20 g granulated sugar
- 500 g flour
- 15 g salt

For the sauce:

- 200 g tomato puree
- 1 tablespoon olive oil
- 1 teaspoon salt

For the filling:

- 250 g ricotta or whey cheese
- 200 g fermented sausage
- 300 g mozzarella in water
- 40 g parmesan cheese
- 2 eggs

PREPARATION

- Mix water, olive oil, yeast and granulated sugar in a pot.
- Pour flour in a separate pot and make a well in the center.
- Pour the liquid mixture into the well and knead for 10 minutes.
- Add salt and knead for 3-4 more minutes.
- Grease a pot with 1 tablespoon olive oil, place the dough you prepared into this pot and cover with aluminum foil.
- Ferment the dough you prepared at 40°C with the static mode of your oven for 1 hour.
- Divide the dough into 4 equal pieces and roll each of them.
- Dust a large pot with flour, place the rounded dough into the pot and rest them for half an hour after covering with damp cloth.
- Mix all ingredients for the sauce in a separate pot.
- Chop up the fermented sausage and mozzarella for the filling into little cubes, then blend the rest of the materials.

- Spread the dough thinly with a rolling pin.
- Place the filling you prepared on half of the rolled dough and close it with the other half of the dough. Twist the edges inside and close tightly.
- Smear the ingredients of the sauce on the dough, then bake.



Notice: The recipe is for 4 calzones.

TURKISH PIZZA INGREDIENTS

For the dough:

- 250 g tepid drinking water (40°C)
- ½ tablespoon olive oil
- 6 g fresh yeast
- 1 teaspoon salt
- 375 g flour
- ½ tablespoon olive oil

For the toppings:

- 200 g low-fat ground beef
- 1 onion, fine-chopped
- 2 cloves of garlic, fine-chopped
- 4 sprigs of parsley, fine-chopped
- 1 green pepper, fine-chopped
- 2 teaspoons tomato paste
- 2 teaspoons red pepper paste
- Salt
- Black pepper
- Cummin
- Paprika

PREPARATION

- Mix water, olive oil, yeast and granulated sugar in a pot.
- Pour flour in a separate pot and make a well in the center.
- Pour the liquid mixture into the well and knead for 10 minutes.
- Add salt and knead for 3-4 more minutes.
- Grease a contained with 1 tablespoon olive oil, place the dough you prepared into this pot and cover with aluminum foil.

- Ferment the dough you prepared at 40°C with the static mode of your oven for 1 hour.
- Divide the dough into 4 equal pieces and roll each of them.
- Dust a large pot with flour, place the rounded dough into the pot and rest them for half an hour after covering with damp cloth.
- Spread the dough thinly with a rolling pin.
- Mix all ingredients for the toppings in a separate pot.
- Smear the topping on the dough, then bake.

 Notice: The recipe is for 4 Turkish pizzas.

TURKISH PITA WITH GROUND MEAT

INGREDIENTS

For the dough:

- 250 g tepid drinking water (40°C)
- 50 g tepid milk
- 25 g fresh yeast
- 25 g granulated sugar
- 500 g flour
- 25 g salt

For the filling:

- 2 onions, fine-chopped
- 300 g low-fat ground beef
- 4 sprigs of parsley, fine-chopped
- 4 tablespoon olive oil
- Salt
- Black pepper

For the edges:

- 50 g ayran
- 1 egg

For the toppings:

- Butter

PREPARATION

- Mix water, olive oil, yeast and granulated sugar in a pot.

- Pour flour in a separate container and make a well in the center.
- Pour the liquid mixture into the well and knead for 10 minutes.
- Add salt and knead for 3-4 more minutes.
- Grease a pot with 1 tablespoon olive oil, place the dough you prepared into this pot and cover with aluminum foil.
- Ferment the dough you prepared at 40°C with the static mode of your oven for 1 hour.
- Divide the dough into 4 equal pieces and roll each of them.
- Dust a large pot with flour, place the rounded dough into the pot and rest them for half an hour after covering with damp cloth.
- Roast onions and ground beef in olive oil in a frying pan. After it is done, add parsley, salt and black pepper and mix.
- Spread the dough not very thinly with a rolling pin.
- Place the filling you prepared on half of the rolled dough, smear ayran-egg mixture on the edge of the part you will wrap on top, then wrap.
- Bake the wrapped pita you prepared.
- Serve the pita buttered after baking.

 Notice: The recipe is for 4 pitas.

PIZZA NAPOLI

INGREDIENTS

For the dough:

- 300 g tepid drinking water (40°C)
- 1 tablespoon olive oil
- 20 g fresh yeast
- 20 g granulated sugar
- 500 g flour
- 15 g salt

For the sauce:

- 200 g tomato puree
- 1 tablespoon olive oil
- 1 teaspoon salt

For the toppings:

- 400 g mozzarella in water
- 20 fillets anchovy
- 4 tablespoons caper
- Olive oil

PREPARATION

- Mix water, olive oil, yeast and granulated sugar in a pot.
- Pour flour in a separate pot and make a well in the center.
- Pour the liquid mixture into the well and knead for 10 minutes.
- Add salt and knead for 3-4 more minutes.
- Grease a contained with 1 tablespoon olive oil, place the dough you prepared into this container and cover with aluminum foil.
- Ferment the dough you prepared for 1 day in the fridge.
- Divide the dough into 4 equal pieces and roll each of them.
- Dust a large pot with flour, place the rounded dough into the pot and rest them for half an hour after covering with damp cloth.
- Mix all ingredients for the sauce in a separate pot.
- Cut the cheese for the topping into large rings.
- Spread the dough with a rolling pin.
- Smear tomato sauce on the rolled dough, add mozzarella cut in rings, anchovies and capers, then bake.

 Notice: The recipe is for 4 pizzas.

PIZZA MARGHERITA

INGREDIENTS

For the dough:

- 300 g tepid drinking water (40°C)
- 1 tablespoon olive oil
- 20 g fresh yeast
- 20 g granulated sugar
- 500 g flour

- 15 g salt

For the sauce:

- 200 g tomato puree
- 1 tablespoon olive oil
- 1 teaspoon salt

For the toppings:

- 400 g mozzarella in water
- 10 sprigs fresh basil
- Olive oil

PREPARATION

- Mix water, olive oil, yeast and granulated sugar in a pot.
- Pour flour in a separate pot and make a well in the center.
- Pour the liquid mixture into the well and knead for 10 minutes.
- Add salt and knead for 3-4 more minutes.
- Grease a pot with 1 tablespoon olive oil, place the dough you prepared into this pot and cover with aluminum foil.
- Ferment the dough you prepared for 1 day in the fridge.
- Divide the dough into 4 equal pieces and roll each of them.
- Dust a large pot with flour, place the rounded dough into the pot and rest them for half an hour after covering with damp cloth.
- Mix all ingredients for the sauce in a separate pot.
- Cut the cheese for the topping into large rings.
- Spread the dough with a rolling pin.
- Smear tomato sauce on the rolled dough, then place the cheese cut into rings on top.
- Before serving, add fresh basil and olive oil after baking.

 Notice: The recipe is for 4 pizzas.

TURKISH PITA WITH CHEDDAR AND PASTRAMI

INGREDIENTS

For the dough:

- 250 g tepid drinking water (40°C)
- 50 g tepid milk
- 25 g fresh yeast
- 25 g granulated sugar
- 500 g flour
- 25 g salt

For the filling:

- 200 g grated cheddar
- 120 g pastrami

For the edges:

- 50 g ayran
- 1 egg

For the toppings:

- Butter

PREPARATION

- Mix water, olive oil, yeast and granulated sugar in a pot.
- Pour flour in a separate container and make a well in the center.
- Pour the liquid mixture into the well and knead for 10 minutes.
- Add salt and knead for 3-4 more minutes.
- Grease a pot with 1 tablespoon olive oil, place the dough you prepared into this pot and cover with aluminum foil.
- Ferment the dough you prepared at 40°C with the static mode of your oven for 1 hour.
- Divide the dough into 4 equal pieces and roll each of them.
- Dust a large pot with flour, place the rounded dough into the pot and rest them for half an hour after covering with damp cloth.
- Mix ingredients necessary for edges in a separate pot.
- Spread the dough not very thinly with a rolling pin.
- Smear the ayran-egg mixture on the edges of the rolled dough, then twist the edges wrapping inside. Smear

some ayran-egg mixture on the wrapped edge as well.

- Place cheddar cheese on the dough, align pastrami side by side, then bake.
- Butter the edges of the pita after baking and serve.



Notice: The recipe is for 4 pitas.

**MIXED PIZZA
INGREDIENTS****For the dough:**

- 300 g tepid drinking water (40°C)
- 1 tablespoon olive oil
- 20 g fresh yeast
- 20 g granulated sugar
- 500 g flour
- 15 g salt

For the sauce:

- 200 g tomato puree
- 4 sprigs fresh thyme
- 1 tablespoon olive oil
- 1 teaspoon salt

For the toppings:

- • 20 slices fermented sausage
- • 200 g sausage
- • 8 slices salami
- • 10 seedless black olives
- • 1 tablespoon canned corn
- • 8 mid-size cultivated mushroom
- • 400 g grated mozzarella
- • Olive oil

PREPARATION

- • Mix water, olive oil, yeast and granulated sugar in a pot.
- • Pour flour in a separate pot and make a well in the center.
- • Pour the liquid mixture into the well and knead for 10 minutes.
- • Add salt and knead for 3-4 more minutes.
- • Grease a pot with 1 tablespoon olive oil, place the dough you prepared into this pot and cover with aluminum foil.

- • Ferment the dough you prepared for 1 day in the fridge.
- • Divide the dough into 4 equal pieces and roll each of them.
- • Dust a large pot with flour, place the rounded dough into the pot and rest them for half an hour after covering with damp cloth.
- • Spread the dough thinly with a rolling pin.
- • Smear tomato sauce on the rolled dough, drizzle some of the mozzarella and add all other ingredients on it, then add the rest of the mozzarella on top and bake.
- • Add olive oil on the baked pizza before serving.

i Notice: The recipe is for 4 pizzas.

How to operate the grill

! Close oven door during grilling. Hot surfaces may cause burns!

i Grilling can be made in single whole section, only top section or in the top section when bottom-top sections are operated.

Grilling in single large section

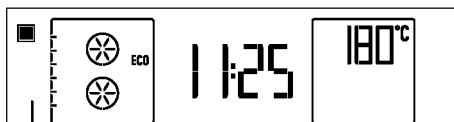

Oven returns to stand-by display after it is powered on for the first time and the current time is set. Only the current time appears on the display.

1. Remove the middle section plate from the oven. Only after the middle section plate is removed the oven timer will work in single large section cooking setting.
2. Switch on the oven touching  for two seconds.
3. When the oven is switched on, the first function peculiar to the single large section cooking will be displayed.

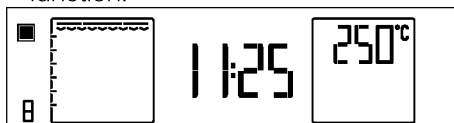

4. Touch **P** to enter the display for setting the operating function.
» The relevant function number will flash on the display.
5. Touch  to select the desired grill function.



6. After the function is selected "Temperature", "Rapid Heating (Booster)", "Cooking time" and "Cooking end time" can be set. see. (Operating the oven as a single section) *How to operate the oven control unit, page 25*
7. If cooking function, temperature and time values are suitable, touch  key to start cooking. Cooking starts.
8. If the cooking time is set, the oven will automatically switch off at the end of this time. Two audible signals will be heard. If no cooking time is set, touch  again to end the cooking when the cooking process is complete.
9. Touch  key to switch off the oven.

Grilling in top section only mode

Oven returns to stand-by display after it is powered on for the first time and the current time is set. Only the current time appears on the display.

1. Place the middle section plate in its housing found between the 3rd and 4th rack guides.
i If the middle section plate is not placed, the oven timer will operate as a whole single section.
2. Switch on the oven touching  for two seconds.

3. When the oven is switched on, the first function peculiar to the single large section cooking will be displayed.



4. Touch to select the desired grill function.



5. After the function is selected "Temperature", "Rapid Heating (Booster)", "Cooking time" and "Cooking end time" can be set. see. (Using the oven only as the top or bottom section) *How to operate the oven control unit, page 25*

6. If cooking function, temperature and time values are suitable, touch to start cooking. Cooking starts.

7. The oven will automatically switch off at the end of the cooking time, if set. Two audible signals will be heard. If no cooking time is set, touch again to end the cooking when the cooking process is complete.

8. Touch key to switch off the oven.

Grilling only in the top section while the top and bottom sections of the oven are in operation

Oven returns to stand-by display after it is powered on for the first time and the current time is set. Only the current time appears on the display.

1. Place the middle section plate in its housing found between the 3rd and 4th rack guides.

If the middle section plate is not placed, the oven timer will operate as a whole single section.

2. Switch on the oven touching for two seconds.

3. When the oven is switched on, the first function peculiar to the single large section cooking will be displayed.

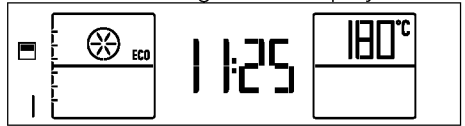

Each time you touch , the bottom section only, both bottom and top sections and the top section only will be activated respectively.

4. Activate both sections by touching twice. will appear next to each oven section.

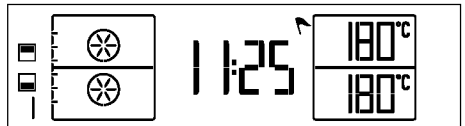

5. Touch to enter the display for setting the operating function.

» The relevant function number will flash on the display.

6. Touching , select the desired function pair with the top section is selected as grill function.



7. After the function is selected, "Temperature" and "Cooking time" can be adjusted separately for each oven section. For these settings symbol of the active cooking section will flash. See. (Using the top and bottom sections of the oven simultaneously) *How to operate the oven control unit, page 25*

8. If cooking function, temperature and time values are suitable, touch key to start cooking. Cooking starts.

9. The oven will automatically switch off at the end of the cooking time, if set. Two audible signals will be heard. If no cooking time is set, touch  again to end the cooking when the cooking process is complete.

10. Touch  key to switch off the oven.



Foods that are not suitable for grilling carry the risk of fire. Only grill food which is suitable for intensive grilling heat. Do not place the food too far in the back of the grill. This is the hottest area and fatty food may catch fire.

For single large section: cooking times table for grilling

Food	Accessory to use	Insertion level	Temperature (°C)	Cooking time (approx. in min.)
Fish	Wire grill	4...5	250	20...25 min. #
Chopped chicken	Wire grill	4...5	250	25...35 min.
Lamb chop	Wire grill	4...5	250	20...25 min.
Roast Beef	Wire grill	4...5	250	25...30 min. #
Veal chop	Wire grill	4...5	250	25...30 min. #
Toast bread	Wire grill	4	250	1...3 min.

depending on thickness
It is suggested to perform a preheating for all foods for approx. 5 minutes.

For top section only: cooking times table for grilling

Food	Accessory to use	Insertion level	Temperature (°C)	Cooking time (approx. in min.)
Fish	Wire grill	4...5	250	20...25 min. #
Chopped chicken	Wire grill	4...5	250	25...35 min.
Lamb chop	Wire grill	4...5	250	20...25 min.
Roast Beef	Wire grill	4...5	250	25...30 min. #
Veal chop	Wire grill	4...5	250	25...30 min. #
Toast bread	Wire grill	4	250	1...3 min.

depending on thickness
It is suggested to perform 5 minutes preheating for all foods broiling.

For single large section: cooking times table for grilling of test meals

easier for control institutes to test the product.

Meals in this cooking table are prepared according to EN 60350-1 to make it

Food	Accessory to use	Insertion level	Temperature (°C)	Cooking time (approx. in min.)
Toast bread	Wire grill	4	250	1...3 min.
Meatballs (beef) - 12 pieces	Wire grill	4	250	25...35 min.

Turn the food after 2/3 of the total grilling time.
It is suggested to perform 5 minutes preheating for all foods broiling.

6 Maintenance and care

General cleaning information

⚠ General warnings

- Wait for the product to cool before cleaning the product. Hot surfaces may cause burns!
- Do not apply the detergents directly on the hot surfaces. This may cause a permanent stains.
- The appliance shall be thoroughly cleaned and dried after each operation. Thus, food residues shall be easily cleaned and these residues shall be prevented from burning when the appliance is used again later. Thus, the service life of the appliance extends and frequently faced problems are decreased.
- Do not use steam cleaning products for cleaning.
- Some detergents or cleaning agents may damage the surface. Do not use abrasive detergents, cleaning powders, cleaning creams, descalers or sharp objects during cleaning.
- There is no need for a special cleaning agent for cleaning after each use. Clean the appliance using dish soap, warm water and a soft cloth or sponge and dry with a dry microfiber cloth.
- Be sure to completely wipe off any remaining liquid after cleaning and immediately clean any food splashing around during cooking.
- Do not wash any component of your appliance in a dishwasher.

Inox and stainless surfaces

- Do not use acid or chlorine-containing cleaning agents to clean stainless or inox surfaces and handles.

- Stainless or inox surface may change colour in time. This is normal. After each operation, clean with a detergent suitable for the stainless or inox surface.
- Clean with a soft soapy cloth and liquid (non-scratching) detergent suitable for inox surfaces, taking care to wipe in one direction.
- Remove lime, oil, starch, milk and protein stains on the inox-stainless and glass surfaces immediately without waiting. Stains may rust under long periods of time.

Enamelled surfaces

- After each use, clean the enamel surfaces using dishwashing detergent, warm water and a soft cloth or sponge and dry them with a dry cloth.
- If your product has an easy steam cleaning function, you can make easy steam cleaning for light non-permanent dirt. (See the "Easy steam cleaning" section)
- For persistent stains, the oven and grill cleaner recommended on the website of your product brand and a non-scratching scouring pad can be used. Do not use an external oven cleaner.
- The oven must cool down for cleaning in the cooking area. Cleaning on hot surfaces shall create both fire hazard and damage with enamel surface.

Catalytic surfaces

- The side walls in the cooking area can only be covered with enamel or catalytic walls. It varies by model.
- The catalytic walls have a light matte and porous surface. The catalytic walls of the oven should not be cleaned.
- Catalytic surfaces absorb oil thanks to its porous structure and start to shine

when the surface is saturated with oil, in this case it is recommended to replace the parts.

Glass surfaces

- When cleaning glass surfaces, do not use hard metal scrapers and abrasive cleaning materials. They can damage the glass surface.
- Clean the appliance using dishwashing detergent, warm water and a microfiber cloth specific for glass surfaces and dry it with a dry microfiber cloth.
- If there is residual detergent after cleaning, wipe it with cold water and dry with a clean and dry microfiber cloth. Residual detergent residue may damage the glass surface next time.
- Under no circumstances should the dried-up residue on the glass surface be cleaned off with serrated knives, wire wool or similar scratching tools.
- You can remove the calcium stains (yellow stains) on the glass surface with the commercially available descaling agent, with a descaling agent such as vinegar or lemon juice.
- If the surface is heavily soiled, apply the cleaning agent on the stain with a sponge and wait a long time for it to work properly. Then clean the glass surface with a wet cloth.
- Discolorations and stains on the glass surface are normal and not defects.

Plastic parts and painted surfaces

- Clean plastic parts and painted surfaces using dishwashing detergent, warm water and a soft cloth or sponge and dry them with a dry cloth.
- Do not use hard metal scrapers and abrasive cleaners. It may damage the surfaces.
- Ensure that the joints of the components of the appliance are not left as damp and with detergent.

Otherwise, corrosion may occur on these joints.

Cleaning the accessories

Unless otherwise stated in the user manual, do not wash the product accessories in the dishwasher.

Cleaning the control panel

- When cleaning the panels with knob control, wipe the panel and knobss with a damp soft cloth and dry with a dry cloth. Do not remove the knobs and gaskets underneath to clean the control panel. The control panel and knobs may be damaged.
- While cleaning the inox panels with knob control, do not use inox cleaning agents around the knobs. The indicators around the knobs may be deleted.
- Clean the touch control panels with a damp soft cloth and dry with a dry cloth. If your product has a key lock feature, set the key lock before performing control panel cleaning. Otherwise, incorrect detection may occur on the keys.

Cleaning the inside of the oven (cooking area)

Follow the cleaning steps described in the "General cleaning information" section according to the surface types in your oven.

Cleaning the side walls of the oven

The side walls in the cooking area can only be covered with enamel or catalytic walls. It varies by model. If there is a catalytic wall, refer to the "Catalytic walls" section for information. If your product is a side rack model, remove the side racks before cleaning your side walls. Then complete the cleaning as described in the "General

cleaning information" section according to the side wall surface type.

To remove the side racks:(Varies depending on the product model.)
(This feature is optional. It may not exist on your product.)

- 1.Remove the front section of the side rack by pulling it in the opposite direction of the side wall.
- 2.Remove the side rack completely by pulling it towards you.

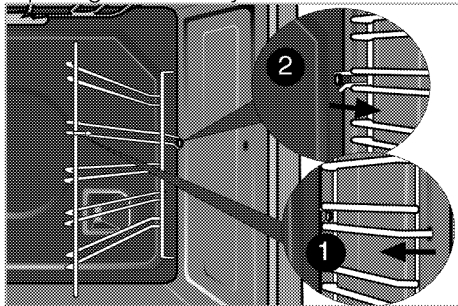

Cleaning the oven door

i Do not use harsh abrasive cleaners, metal scrapers, wire wool or bleach materials to clean the oven door and glass.

You can remove your oven door and door glasses to clean them. How to remove the doors and windows is explained in the sections "Removing the oven door" and "Removing the inner glasses of the door". After removing the door inner glasses, clean them using a dishwashing detergent, warm water and a soft cloth or sponge and dry them with a dry cloth. Wipe the glass with vinegar and then rinse it against lime residues that may occur on the oven glass.

Removing the oven door

- 1.Open the front door (1).
- 2.Open the clips at the hinge housing (2) on the right and left hand sides of the front door by pressing them down as illustrated in the figure.

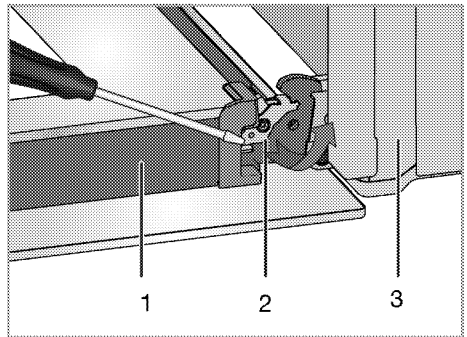

- 1 Door
- 2 Hinge lock(closed position)
- 3 Oven
- 4 Hinge lock(open position)

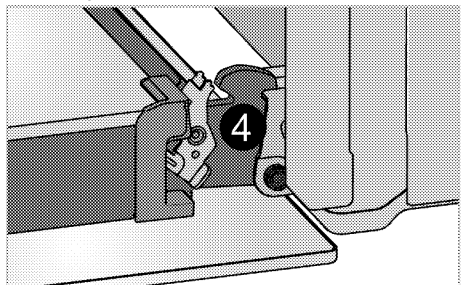

- 3.Move the front door to half-way.

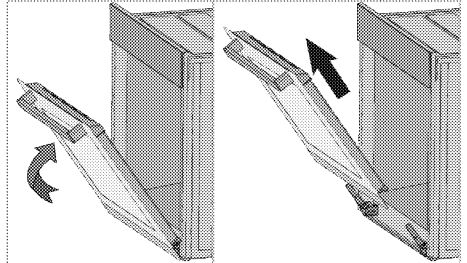

- 4.Remove the front door by pulling it upwards to release it from the right and left hinges.

i Steps carried out during removing process should be performed in reverse order to install the door. Do not forget to close the clips at the hinge housing when reinstalling the door.

Removing the door inner glass

(This feature is optional. It may not exist on your product.)

The inner glass panel of the oven door can be removed for cleaning.

1. Open the oven door.

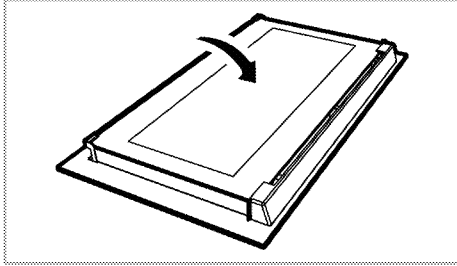

2. Pull towards yourself and remove the plastic part installed to upper section of the front door.

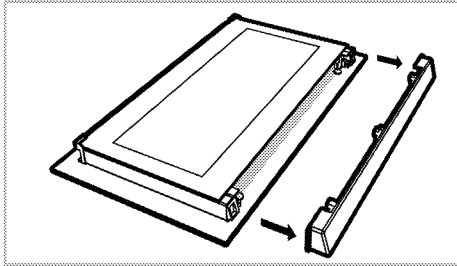

3. As illustrated in figure, raise the innermost glass panel (1) slightly in direction **A** and pull it out in direction **B**.

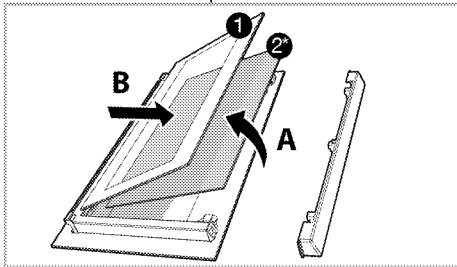

1 Innermost glass panel

2* Inner glass panel (This may not exist on your product.)

4. If your product is equipped with an inner glass panel; repeat the same

procedure to remove the inner glass panel (2).

5. The first step to regroup the door is reinstalling inner glass panel (2). Place the chamfered corner of the glass panel so that it will rest in the chamfered corner of the plastic slot. (If your product is equipped with an inner glass panel). Inner glass panel (2) must be installed into the plastic slot close the innermost glass panel (1).

6. When installing the innermost glass panel (1), make sure that the printed side of the panel faces towards the inner glass panel. It is important to seat lower corner of innermost glass panel (1) into the lower plastic slot.

7. Push the plastic part towards the frame until you hear a "click".

Cleaning the oven lamp

In the event that the glass door of the oven lamp in the cooking area becomes dirty; clean using dishwashing detergent, warm water and a soft cloth or sponge and dry with a dry cloth. In case of oven lamp failure, you can replace the oven lamp by following the sections that follow.

Replacing the oven lamp

⚠ General warnings

- To avoid the risk of electric shock before replacing the oven lamp, disconnect the electrical connector and wait for the oven to cool. Hot surfaces may cause burns!
- In this oven, an incandescent lamp with a power of less than 40 W, a height of less than 60 mm, a diameter of less than 30 mm or a halogen lamp with socket type G9, a power of less than 60 W is used. The lamps are suitable for operation at temperatures above 300 °C. Oven lamps can be obtained from Authorised Service Agents or technician with licence.

- The position of the lamp may differ from that is shown in the figure.
- The lamp used in this product is not suitable for use in the lighting of home rooms. The purpose of this lamp is to help the user see food products.
- The lamps used in this product must withstand extreme physical conditions such as temperatures above 50 ° C.

If your oven has a round lamp,

1. Disconnect the product from the electricity.
2. Remove the glass cover by turning it counterclockwise.

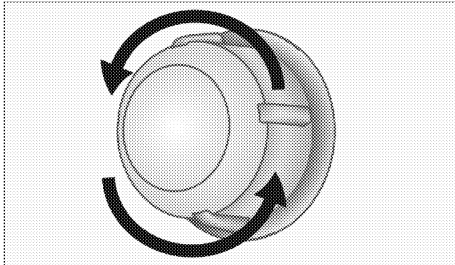

3. If your oven lamp is type (A) shown in the figure below, rotate the oven lamp as shown in the figure and replace it with a new one. If type (B) is a model, pull it out as shown in the figure and replace it with a new one.

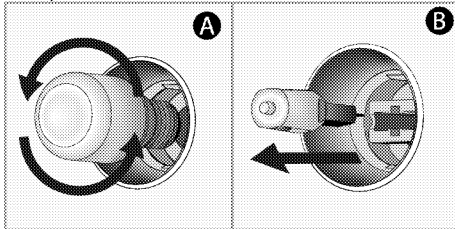

4. Refit the glass cover.

If your oven has a square lamp,

1. Disconnect the product from the electricity.
2. Remove the wire shelves according to the description.

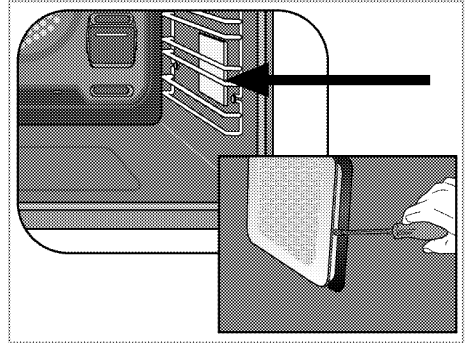

3. Lift the lamp's protective glass cover with a screwdriver.
4. If your oven lamp is type (A) shown in the figure below, rotate the oven lamp as shown in the figure and replace it with a new one. If type (B) is a model, pull it out as shown in the figure and replace it with a new one.

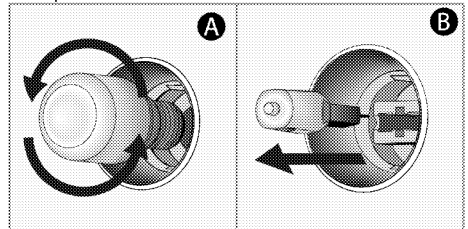

5. Refit the glass cover and wire shelves.

7 Troubleshooting

Oven emits steam when it is in use.

- It is normal that steam escapes during operation. >>> *This is not a fault.*

Product emits metal noises while heating and cooling.

- When the metal parts are heated, they may expand and cause noise. >>> *This is not a fault.*

Product does not operate.

- The mains fuse is defective or has tripped. >>> *Check fuses in the fuse box. If necessary, replace or reset them.*
- Product is not plugged into the (grounded) socket. >>> *Check the plug connection.*

Oven light does not work.

- Oven lamp is defective. >>> *Replace oven lamp.*
- Power is cut. >>> *Check if there is power. Check the fuses in the fuse box. If necessary, replace or reset the fuses.*

Oven does not heat.

- Might not be set to a certain cooking function and/or temperature. >>> *Set the oven to a certain cooking function and/or temperature.*
- Power is cut. >>> *Check if there is power. Check the fuses in the fuse box. If necessary, replace or reset the fuses.*



Consult the Authorised Service Agent or technician with licence or the dealer where you have purchased the product if you can not remedy the trouble although you have implemented the instructions in this section. Never attempt to repair a defective product yourself.

