



Dryer
User Manual



DPS 7405 W3



EN

2960312273_EN230321.1030

Please read this user manual first!

Dear Customer,
Thank you for preferring a Beko product. We hope that your product which has been manufactured with high quality and technology will give you the best results. We advise you to read through this manual and the other accompanying documentation carefully before using your product and keep it for future reference. If you transfer the product to someone else, give its manual as well. Pay attention to all details and warnings specified in the user manual and follow the instructions given therein.
Use this user manual for the model indicated on the cover page.



- Read the instructions.

Explanation of symbols

Throughout this user manual the following symbols are used:



DANGER!

- Warning against electric shock.



DANGER!

- Warning against fire hazard.



WARNING!

- Warning for hazardous situations with regard to life and property.



WARNING!

- Warning against hot surfaces.



WARNING!

- Warning against scalding hazard.



NOTE

- Important information or useful hints about usage.



Packaging materials of the product are manufactured from recyclable materials in accordance with our National Environment Regulations.

Do not dispose of the packaging wastes with the domestic waste or other wastes, discard them to the dedicated collection points designated by the local authorities.



This product was manufactured using the latest technology in environmentally friendly conditions.

1 Important instructions for safety and environment



NOTE

- This section contains safety instructions that will help protect from risk of personal injury or property damage. Failure to follow these instructions shall void any warranty.

1.1 General safety



WARNING!

The dryer can be used by children at and above 8 years old and by persons whose physical, sensory or mental capabilities were not fully developed or who lack experience and knowledge provided that they are supervised or trained on the safe usage of the product and the risks it brings out. Children should not play with the product. Cleaning and maintenance works should not be performed by children unless they are supervised by someone. Children of less than 3 years should be kept away unless continuously supervised.

- Adjustable feet should not be removed. The gap between the dryer and the floor should not be reduced with materials such as carpet, wood and tape. This will cause problems with the dryer.



WARNING!

Always have the installation and repairing procedures carried out by the Authorized Service. Manufacturer shall not be held liable for damages that may arise from procedures carried out by unauthorized persons.

- Never wash the dryer by spraying or pouring water onto it! There is the risk of electric shock!

For the products with a steam function:



WARNING!

- Use only distilled water or water condensed in the water tank of the machine in steam programs. Do not use mains water or additives. When using condensed water in the water tank, it should be filtered and cleared of fibres.
- Do not open the door when steam programs are running. Hot water may be expelled.
- Before putting laundry in a steam program, stains on it should be removed.
- You may only put laundry that is not dirty or stained but permeated with unpleasant odour in steam (odour removal) program.
- Do not use any dry cleaning sets or additional materials in a steam program or in any program.

1.1.1 Electrical safety



DANGER!

- Electrical safety instructions should be followed while electrical connection is made during the installation.
- The appliance must not be supplied through an external switching device, such as a timer, or connected to a circuit that is regularly switched on and off by utility.
- Connect the dryer to a grounded outlet protected by a fuse at the value specified on the type label. Have the grounding installation performed by a qualified electrician. Our company shall not be liable for any damages that will arise when the dryer is used without grounding in accordance with the local regulations.
- The voltage and allowed fuse protection is stated on the type label plate.
- The voltage specified on the type label must be equal to your mains voltage.
- Unplug the dryer when it is not in use.
- Unplug the dryer from the mains during installation, maintenance, cleaning and repair works.
- Do not touch the plug with wet hands! Never unplug by pulling on the cable, always pull out by grabbing the plug.



DANGER!

- Do not use extension cords, multi-plugs or adaptors to connect the dryer to power supply in order to decrease the risk of fire and electric shock.
- Power cable plug must be easily accessible after installation.
- Damaged mains cable should be changed notifying the Authorized Service.
- If the dryer is faulty, it must not be operated unless it is repaired by an authorized service agent! There is the risk of electric shock!

1.1.2 Product safety



DANGER!

- Superheating of the clothes inside of the dryer can occur if you cancel the programme or in the event of a power failure whilst the dryer is running, this concentration of heat can cause self-combustion and fire so always activate the ventilation programme to cool down or quickly remove all laundry from the dryer in order to hang them up and dissipate the heat.



DANGER!

Points to be taken into

consideration for fire hazard:

Below specified laundry or items must not be dried in the dryer considering fire hazard.

- Unwashed laundry items
- Items soiled with oil, acetone, alcohol, fuel oil, kerosene, stain removers, turpentine, paraffin or paraffin removers must be washed in hot water with plenty of detergent before being dried in the dryer.

For this reason especially the items containing the above specified stains must be washed very well, to do this use adequate detergent and choose a high washing temperature.

Below specified laundry or items must not be dried in the dryer due to the fire hazard:

- Garments or pillows bolstered with rubber foam (latex foam), shower bonnets, water resistant textiles, materials with rubber reinforcement and rubber foam pads.

Clothing cleaned with industrial chemicals.

Items such as lighter, match, coins, metal parts, needle etc. may damage the drum set or may lead to functional problems. Therefore check all the laundry that you will load into your dryer.



DANGER!

- Never stop your dryer before the programme completes. If you must do this, remove all laundry quickly and lay them out to dissipate the heat.
- Clothes that are washed inadequately may ignite on their own and even may ignite after drying ends.
- You must provide enough ventilation in order to prevent gases exiting from devices operating with other types of fuels including the naked flame from accumulating in the room due to the back fire effect.



WARNING!

- Underwear that contains metal reinforcements should not be dried in the dryer. Dryer may be damaged if metal reinforcements come loose and break off during drying.



NOTE

- Use softeners and similar products in accordance with the instructions of their manufacturers.
- Always clean the lint filter before or after each loading. Never operate the dryer without the lint filter installed.



WARNING!

- Never attempt to repair the dryer by yourself. Do not perform any repair or replacement procedures on the product even if you know or have the ability to perform the required procedure unless it is clearly suggested in the operating instructions or the published service manual. Otherwise, you will be putting your life and others' lives in danger.
- There must not be a lockable, sliding or hinged door that may block the opening of the loading door in the place where your dryer is to be installed.
- Install your dryer at places suitable for home use. (Bathroom, closed balcony, garage etc.)
- Make sure that pets do not enter the dryer. Check the inside of the dryer before operating it.
- Do not lean on the loading door of your dryer when it is open, otherwise it may fall over.
- The lint must not be allowed to accumulate around the tumble dryer
- The tumble dryer is not to be used if industrial chemicals have been used for cleaning.
- Fabric softeners, or similar products, should be used as specified by the fabric softener instructions.
- Exhaust air must not be discharged into a flue which is used for exhausting fumes from appliances burning gas or other fuels.

1.2 Mounting over a washing machine

- A fixing device should be used between the two machines when installing the dryer above a washing machine. The fitting device must be installed by the authorized service agent.
- Total weight of the washing machine and the dryer -with full load- when they are placed on top of each other reaches to approx. 180 kilograms. Place the products on a solid floor that has sufficient load carrying capacity!



WARNING!

- Washing machine cannot be placed on the dryer. Pay attention to the above warnings during the installation on your washing machine.

Installation Table for Washing Machine and Dryer

Dryer Depth	Washing Machine Depth			
	62 cm	60 cm	54 cm	< 50 cm
54 cm	Can be installed			Cannot be installed
60 cm	Can be installed		Cannot be installed	

1.3 Intended use

- Dryer has been designed for domestic use. It is not suitable for commercial use and it must not be used out of its intended use.
- Use the dryer only for drying laundry that are marked accordingly.
- The manufacturer waives any responsibility arisen from incorrect usage or transportation.
- The service life of the dryer that you purchased is 10 years. During this period, original spare parts will be available to operate the dryer properly.

1.4 Child safety

- Packaging materials are dangerous for the children. Keep packaging materials away from children.
- Electrical products are dangerous for the children. Keep children away from the product when it is operating. Do not let them tamper with the dryer. Use the child-proof lock in order to prevent the children to tamper with the dryer.

 NOTE
Child-proof lock is on the control panel. (See Child lock)

- Keep loading door closed even when the dryer is not in use.

1.5 Compliance with the WEEE Directive and Disposing of the Waste Product:



This product complies with EU WEEE Directive (2012/19/EU). This product bears a classification symbol for waste electrical and electronic equipment (WEEE).

This symbol indicates that this product shall not be disposed with other household wastes at the end of its service life. Used device must be returned to official collection point for recycling of electrical and electronic devices. To find these collection systems please contact to your local authorities or retailer where the product was purchased. Each household performs important role in recovering and recycling of old appliance. Appropriate disposal of used appliance helps prevent potential negative consequences for the environment and human health.

1.6 Compliance with RoHS Directive

The product you have purchased complies with EU RoHS Directive (2011/65/EU). It does not contain harmful and prohibited materials specified in the Directive.

1.7 Package information

Packaging materials of the product are manufactured from recyclable materials in accordance with our National Environment Regulations. Do not dispose of the packaging materials together with the domestic or other wastes. Take them to the packaging material collection points designated by the local authorities.

1.8 Technical Specifications

EN

Height (Min. / Max.)	84,6 cm / 86,6 cm*
Width	59,7 cm
Depth	58,9 cm
Capacity (max.)	7 kg**
Net weight (\pm %10)	44 kg
Voltage	See type label***
Rated power input	
Model code	

* Min. height: Height with adjustable feet are closed.

Max. height: Height with adjustable feet are opened maximum.

** Dry laundry weight before washing.

*** Type label is located behind the loading door.

 NOTE
<ul style="list-style-type: none">• Technical specifications of the dryer are subject to specification without notice to improve the quality of the product.• Figures in this manual are schematic and may not match the product exactly.• Values stated on markers on the dryer or in the other published documentation accompanying with the dryer are obtained in laboratory in accordance with the relevant standards. Depending on operational and environmental conditions of the dryer, these values may vary.

2 Your Dryer

2.1 Overview

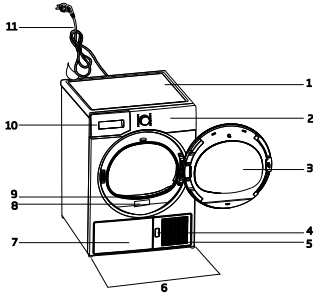

1. Top panel
2. Control panel
3. Loading door
4. Kick plate opening button
5. Ventilation grids
6. Adjustable legs
7. In models where the tank is placed below, the water tank is inside the toe board
8. Type label
9. Lint filter
10. Water tank drawer (in models where the tank is placed above)
11. Power cord

2.2 Package Contents

	1. Water drain hose *		6. Water Filling Container*
	2. Filter drawer spare sponge*		7. Pure Water*
	3. User Manual		8. Fragrance Capsules Group*
	4. Drying basket*		9. Brush*
	5. Drying basket user manual*		10. Filter cloth*

*Optional - may not be included, depends on model.

3 Installation

Before installation, ensure that electrical installation and water drain is appropriate referring to the user's manual. If they are not suitable, contact a qualified electrician and technician to make necessary arrangements.



NOTE

- Preparation of the dryer's location as well as the electrical and waste water installations is under customer's responsibility.



WARNING!

- Prior to installation, visually check if the dryer has any defects on it. If the drier is damaged, do not have it installed. Damaged products cause risks for your safety.
- Let your dryer wait for 12 hours before starting to use it.

3.1 Appropriate installation location

Install the dryer on a stable and level surface. Dryer is heavy. Do not move it by yourself.

- Operate your dryer in a well ventilated, dust-free environment.
- The gap between the dryer and the surface should not be reduced by the materials such as carpet, wood and tape.
- Do not cover the ventilation grills of the dryer.
- There must not be a lockable, sliding or hinged door that may block the opening of the loading door in the place where your dryer is to be installed.
- Once the dryer is installed, it should stay at the same place where its connections have been made. When installing the dryer, make sure that its rear wall does not touch anywhere (tap, socket, etc.).
- Place the dryer at least 1 cm away from the edges of other furniture.
- Your dryer can be operated at temperatures between +5°C and +35°C. If the operating conditions fall outside of this range, operation of the dryer will be adversely affected and it can get damaged.

- The rear surface of the tumble dryer shall be placed against a wall.



DANGER!

Do not place the dryer on the power cable.

*** Ignore following warning if your product's system does not contains R290.**



DANGER!

- Dryer contains R290 refrigerant.*
- R290 is an environment-friendly, but flammable refrigerant.*
- Ensure that the air inlet of the dryer is open and it is well-ventilated.*
- Keep potential flame sources away from the dryer.*

3.2 Removing the transportation safety assembly



WARNING!

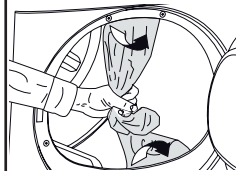

- Remove the transportation safety assembly before using the dryer for the first time.
- If the door swing side of your appliance can be modified, see the reversible door mounting instructions.

3.3 Connecting to the drain

You can directly drain accumulated water through the water drain hose supplied with the product instead of periodically draining the water collected in the water tank.

Connecting the water drain hose

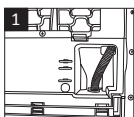
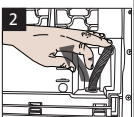
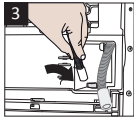
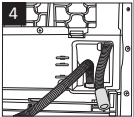
		1-2 Pull hose at the behind of the dryer by hand in order to disconnect it from where it is connected. Do not use any tools to remove the hose.
		
3 Connect one end of the drain hose supplied with the dryer to the connection point from where you removed the hose of the product in previous step.		
4 Connect the other end of the drain hose directly to the wastewater drain or to the washbasin.		

NOTE

- Water drain hose should be attached to a height of maximum 80 cm.
- Make sure that the water drain hose is not stepped on and it is not folded between the drain and the machine.
- If there is an accessories pack supplied with your product, please see the detailed description.

3.4 Adjusting the feet

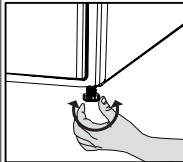
	<ul style="list-style-type: none">• Turn the feet to left or right until the dryer stands level and firmly.
--	---

3.5 Transportation of the dryer

Drain all water that has remained in the dryer. If direct water drain connection is made, then remove the hose connections.

WARNING!

- We recommend carrying the dryer in upright position. If it is not possible to carry the machine in the upright position, we recommend carrying it by tilting towards the right side when looked from the front.

3.6 Warnings about sounds

NOTE

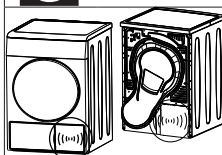

- It is normal to hear a metallic noise from the compressor sometimes during operation.
- Water collected during operation is pumped to water tank. It is normal to hear pumping noise during this process.

3.7 Changing the illumination lamp

In case an illumination lamp is used in your laundry dryer. To change the Bulb/LED used for illumination of your tumble dryer, call your Authorised Service Agent. The lamp(s) used in this appliance is not suitable for household room illumination. The intended purpose of this lamp is to assist the user to place laundry in the tumble dryer in a comfortable way. The lamps used in this appliance have to withstand extreme physical conditions such as vibrations and temperatures above 50 °C

4 Preparation

4.1 Laundry suitable for drying in the dryer

Always obey the instructions given on the garment tags. Dry only the laundry having a label stating that they are suitable for drying in a dryer.

4.2 Laundry not suitable for drying in the dryer



Items with this symbol should not be dried in the dryer.



NOTE

- Delicate embroidered fabrics, woollen, silk garments, delicate and valuable fabrics, airtight items and tulle curtains are not suitable for machine drying.

4.3 Preparing laundry for drying

- Laundry may be tangled with each other after washing. Separate the laundry items before placing them into the dryer.
- Dry garments having metal accessories such as zippers, inside out.
- Fasten the zippers, hooks and buckles and button sheets.

4.4 Things to be done for energy saving

- Spin your laundry at the highest speed possible when washing them. Thus, the drying time is shortened and energy consumption is reduced.
- Sort out the laundry depending on their type and thickness. Dry the same type of laundry together. For example thin kitchen towels and tablecloths dry quicker than thick bathroom towels.
- Follow the instructions in the user manual for programme selection.
- Do not open the loading door of the machine during drying unless necessary. If you must open the loading door, do not keep it open for a long time.
- Do not add wet laundry while the dryer is in operation

- For models with a condenser unit: clean the condenser once in a month or after every 30 operations regularly.
- Clean the filter periodically. Read the Maintenance and cleaning of filters for detailed information.
- For models with flue unit: comply with the flue connection instructions and clean the flue.
- During the drying process, air the room well where your tumble dryer is operating
- On models with heat pump, check the condenser at least every 6 months and clean it if it is dirty.
- If you are using the environmentally-friendly filter, you do not need to clean it at every cycle. Replace the filter cloth when the environmentally-friendly filter symbol is displayed on the screen..

4.5 Correct load capacity

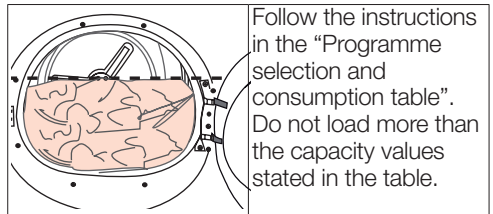

Following weights are given as examples.

Laundry	Approximate weights (g)*	Laundry	Approximate weights (g)*
Cotton quilt covers (double)	1500	Blouses	150
Cotton quilt covers (single)	1000	Cotton shirts	300
Bed sheets (double)	500	Shirts	250
Bed sheets (single)	350	Cotton dresses	500
Large tablecloths	700	Dresses	350
Small tablecloths	250	Jeans	700
Tea towels	100	Handkerchiefs (10 pieces)	100
Bath towels	700	T-Shirts	125
Hand towels	350		

*Dry laundry weight before washing.

5 Operating the product

5.1 Control panel

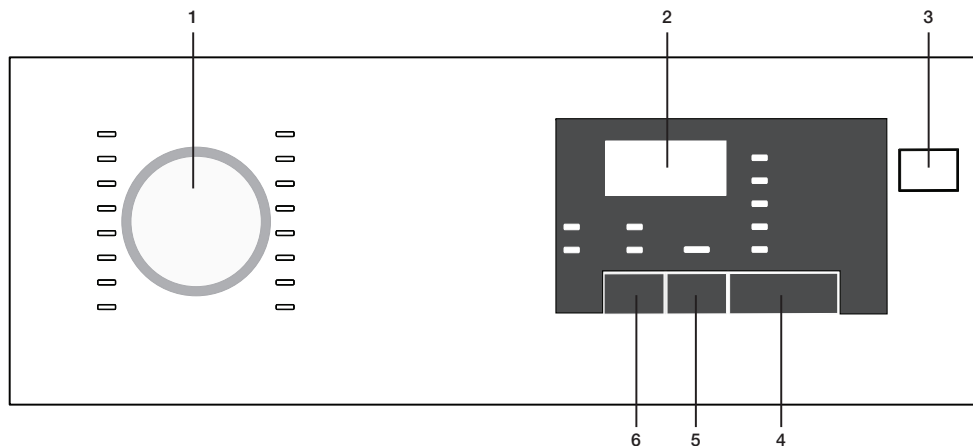

1. Program selection knob
2. Remaining duration indicator
3. On/Off button
4. Start/pause button
5. End duration button
6. Sound warning button

5.2 Screen symbols

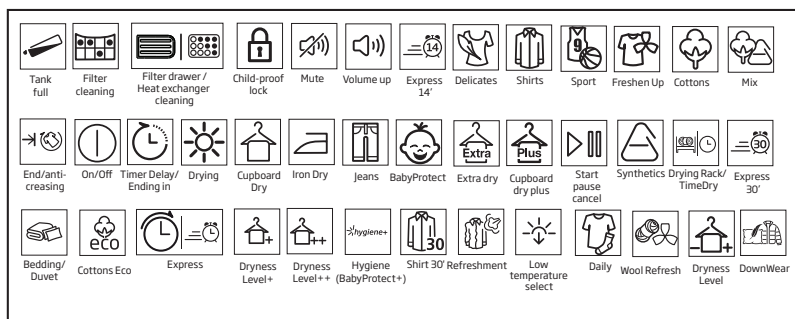

5.3 Preparing the machine

1. Plug in the machine
2. Place laundry inside the machine.
3. Press the On/Off button.
4. When your machine turns on for the first time, it turns on with the declaration (cotton cabinet dryness) program.

5.4 Program selection

1. Determine the appropriate program from the chart below containing the drying levels.
2. Select the program you desire using the Program Selection knob.



NOTE

- Pressing the On/Off button doesn't mean the program starts.
- Press the Start / Pause button to start the program.

5.5 Program selection and consumption table

EN				
Programmes	Programme Description	Capacity (kg)	Spin speed in washing machine (rpm)	Drying Time (minutes)
Cottons Iron Dry	You may dry your cotton laundry to be ironed in this program to have them slightly damp for ease of ironing. (Shirt, T-shirt, tablecloth, etc.)	7	1000	140
Cottons Cupboard Dry	It dries single layer, casual cotton textiles in the most economical way.	7	1000	174
Cottons Cupboard Dry Plus	You may use this program for extra dryness in thick laundry such as pants, tracksuit. You can put your laundry in the wardrobe without ironing.	7	1000	180
Cottons Extra Dry	You may dry your thick cotton laundry in this program such as towels, bathrobe, etc. You can put your laundry in the wardrobe without ironing.	7	1000	185
Synthetics Iron Dry	You may dry your synthetic laundry to be ironed in this program to have them slightly damp for ease of ironing. (Shirt, T-shirt, tablecloth, etc.)	4	800	60
Synthetics Cupboard Dry	You may dry all your synthetic laundry in this program. (Shirt, T-shirt, underwear, tablecloth, etc.) You can put your laundry in the wardrobe without ironing.	4	800	70
Delicates	You may dry your delicate laundry or laundry with hand wash symbol (silk blouses, thin underwear, etc.) at low temperature in this program.	2	600	70
Freshen up	It just provides airing for 10 minutes without any hot air. You can air the cotton and linen laundry that are kept closed for a long time, and eliminate the odour in them.	-	-	10
Time Programmes	You may select from time programs between 30 and 45 minutes to achieve the desired drying level at low temperature. In this program, tumble drier's operation lasts for the set time independently from the dryness of laundry.	-	-	-
Shirts	It dries the shirts in a more sensitive manner, and causes less creasing and easier ironing.	1,5	1200	60
Sport	You may dry your sports clothes that are appropriate for tumble drying in this program.	4	1000	135
Babyprotect	Program used for baby clothing with can be dried approval on the label.	3	1000	80
Express	You can use this program to dry your cotton laundry that you have spun at high speeds in your washing machine.	1	1200	50
Daily	You can dry both cotton and synthetic laundry with this programme. Sports and fitness clothes may be dried with this program.	4	1200	110
Jeans	You may dry denim pants, skirts, shirts or jackets in this program.	4	1200	150

Energy consumption values					
Programmes	Capacity (kg)	Spin speed in washing machine (rpm)	Approximate amount of remaining humidity	Energy consumption value kWh	
Cottons cupboard dry*	7	1000	60%	1,68	
Cottons Iron dry	7	1000	60%	1,3	
Synthetics cupboard dry	4	800	40%	0,59	
Contains fluorinated greenhouse gases covered by the Kyoto Protocol. Hermetically sealed. R450a / 0,22 kg -GWP:604 -0,133 tCO ₂ e					
	"Cotton cupboard dry programme" used at full and partial load is the standard drying programme to which the information in the label and the fiche relates, that this programme is suitable for drying normal wet cotton laundry and that it is the most efficient programme in terms of energy consumption for cotton.				

* : Energy Label standard program (EN 61121) "All the filters must be cleaned prior to test series." All the values in the table are determined according to EN 6112 standard. Consumption values may vary from the values in the table depending on laundry type, wringing revolution, ambient conditions and changes in voltage.



NOTE

- Extra programs may vary according to the specifications of your machine.
- In order to receive better results from drying machine programs, your laundry should be washed with the appropriate program in your washing machine and wringed with recommended wringing revolution..
- Very little dampness might remain on the shirts after the program. It is recommended that you do not leave the shirts in the drying machine
- It is recommended to dry your delicates in laundry bag to prevent wrinkles and damage. When the program ends, take your laundry out of the machine immediately and hang them to prevent wrinkles.

5.6 Auxiliary functions

Sound warning cancel

Drying machine makes sound warnings when the program is completed. If you don't want sound notifications, press the "Sound Notification" button.

When you press the sound notification button it lights up, and program does not make sound notifications when completed.



NOTE

- You can select this function before or after the program starts.

5.7 Warning symbols



NOTE

- Warning symbols may vary according to the specifications of your machine.

Fiber filter cleaning

When the program is completed, a warning led lights up, which indicates that the filter has to be cleaned.



NOTE

- If the filter cleaning led blinks, see the „Troubleshooting“ chapter.

Water tank

When the program is completed, a warning led lights up, which indicates that the water tank must be emptied.

If the water tank fills up while the program is running, warning led starts blinking and the machine goes into stand-by. In that case empty the water in the water tank and start the program by pressing the Start / Pause button. Warning led turns off and the program resumes.



Loading door open

Start/Pause led blinks when the loading door of the drying machine is open.

5.8 End duration

You can delay the end duration of the program for up to 24 hours with the end duration function.

1. Open the loading door and place your laundry.
2. Select the drying program.
3. Press the end duration selection button and set the delay duration you want. End duration led lights up. (End duration moves continuously when you keep pressing the button).
4. Press the Start / Pause button. End duration countdown begins. The “:” sign in the middle of the displayed delay duration blinks.



NOTE

- You can add or remove laundry for the duration of the end duration. The duration displayed on the screen is the sum of the normal drying duration and the end duration. At the end of the countdown the end duration led turns off, drying beings and drying led lights up.

Changing the end duration

If you want to change the duration during the countdown:

1. Cancel the program by pressing the On/Off button. Turn on the drying machine again by pressing the On/Off button. When your drying machine turns on for the first time, it turns on with the declaration (cotton wardrobe dryness) program.
2. Select the program you desire using the Program Selection knob.
3. Repeat the end duration operation for the duration you want.
4. Start the program by pressing the Start / Pause button.

Canceling the end duration function

If you want to cancel the end duration setting countdown and start the program right away:

1. Cancel the program by pressing the On/Off button. Turn on the drying machine again by pressing the On/Off button. When your drying machine turns on for the first time, it turns on with the declaration (cotton wardrobe dryness) program.
2. Select the program you desire using the Program Selection knob.
3. Start the program by pressing the Start / Pause button.

5.9 Starting the program

Start the program by pressing the Start / Pause button.

Start/Pause led and the Drying led light up, indicating the program started. The “:” sign in the middle of the remaining duration starts to blink.

5.10 Child Lock

The machine features a child lock which prevents the machine program flow from being affected when buttons are pressed during operation.

When the Child Lock is active, all buttons except for the On/Off button are deactivated. To activate the child lock, press the Sound Notification button and End Duration button simultaneously for 3 seconds.

The child lock should be deactivated to be able to start a new program after the current program ends or to be able to interfere with the current program. Keep the same buttons pressed for 3 seconds again to deactivate the child lock.



NOTE

- The lock led on the screen lights up when the Child Lock is activated.
- Child Lock deactivates when the machine is turned off and on again using the On/Off button.

A warning sound is heard when any button is pressed (except for On/Off button) or the Program Selection knob is turned while the child lock is active.

5.11 Changing the program after it is started

After the machine starts running, you can change the program you selected to dry your laundry with a different program.

1. For example, to select Extra Dry program instead of the Iron Dryness, stop the program by pressing the Start / Pause button.
2. Turn the Program Selection knob to select the Extra Dry program.
3. Start the program by pressing the Start / Pause button.

Adding and removing laundry in stand-by mode

If you want to add or remove laundry after the drying program starts:

1. Press the Start/Pause button to take the machine into Stand-by mode. Drying operation stops.
2. Open the loading door, add or remove laundry and close the loading door.
3. Start the program by pressing the Start / Pause button.



NOTE

- The laundry adding made after the drying operation started may cause the dried laundry inside the machine to mix with the wet laundry and the laundry to remain damp after the operation ends.
- If a new program is selected by changing the position of the program selection knob while your machine is in stand-by mode, the running program ends.
- Laundry adding and removing can be repeated as much as desired during drying operation. But this process would continuously interrupt the drying operation, and so would cause the program duration to lengthen and increase energy consumption. Thus, it is recommended to add laundry before the program starts.



WARNING!

- Do not contact the inner surface of the drum when adding or removing laundry during a continuing program. The drum surface is hot.

5.12 Canceling the program

If you want to cancel the program and end the drying operation for any reason after the machine starts running, press the On/Off button.



WARNING!

- As it will be extremely hot inside the machine when you cancel the program while the machine is in operation; run the ventilation program to cool it down.

5.13 Program end

When the program ends, the Final/Wrinkle Prevention, Fiber Filter Cleaning and Water Tank Warning leds on the program follow up indicator light up. Loading door can be opened and machine becomes ready for a second run. Press the On/Off button to turn off the machine.



NOTE

- In case the laundry is not removed after the program is completed, the wrinkle prevention program that lasts 2 hours start in order to prevent wrinkling of the laundry that remains inside the machine.
- Clean the fiber filter after each drying. (See. „Fiber filter and loading door inner surface“)
- Empty the water tank after each drying. (See. „Emptying the water tank“)

6 Maintenance and cleaning

Service life of product extends and frequently experienced problems will be reduced if it is cleaned at regular intervals.



WARNING!

- Please unplug your product before performing maintenance and cleaning instructions. (eg control panel, body, etc.)

6.1 Cleaning Lint Filter / Loading Door Inner Surface

Lint and fiber released from the laundry to the air during the drying cycle are collected in the Lint Filter.



NOTE

- You can clean the lint filter housing with a vacuum cleaner.



WARNING!

- Always clean the lint filter and the inner surfaces of the loading door after each drying process.

To clean the lint filter:

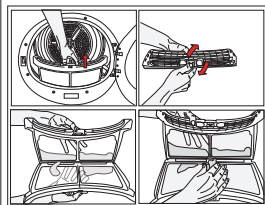

- Open the loading door.
- Remove the lint filter by pulling it up and open the lint filter.

- Clean lint, fiber, and cotton raveling by hand or with a soft piece of cloth.
- Close the lint filter and place it back into its housing.

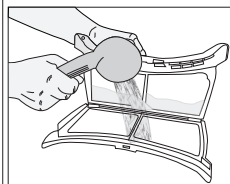

A layer can build up on the filter pores that can cause clogging of the filter after using the dryer for a while. Wash the lint filter with warm water to remove the layer that builds up on the lint filter surface. Dry the lint filter completely before reinstalling it.

- Clean the entire inner surface of the loading door and loading door gasket with a soft damp cloth.

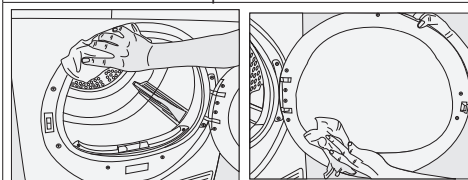

6.2 Cleaning the sensor

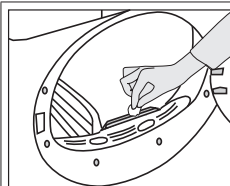

There are dampness sensors in the dryer that detect whether the laundry is dry or not. To clean the sensors:

- Open the loading door of the dryer.
- Allow the machine to cool down if it is still hot due to the drying process.
- Wipe the metal surfaces of the sensor with a soft cloth, dampened with vinegar and dry them.



NOTE

- Clean metal surfaces of the sensors 4 times a year.
- Do not use metal tools when cleaning metal surfaces of the sensors.



WARNING!

- Never use solvents, cleaning agents or similar substances for cleaning due to the risk of fire and explosion!

6.3 Draining the water tank

Dampness of the laundry is removed and condensed during drying process and the water that arise accumulates in the water tank. Drain the water tank after each drying cycle.



WARNING!

- Condensed water is not drinkable!
- Never remove the water tank when the program is running!

If you forget to drain the water tank, the machine will stop during the subsequent drying cycles when the water tank is full and the Water Tank warning symbol will flash. If this is the case, drain the water tank and press Start / Pause button to resume the drying cycle.

To drain the water tank:

1. Remove the water tank in the drawer or container carefully.

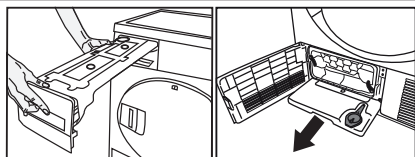

2. Drain the water in the tank.

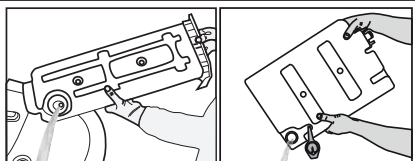

- If there is lint accumulation in the funnel of the water tank, clean it under running water.
- Place the water tank into its seat.



NOTE

- If the direct water draining is used as an option, there is no need to empty the water tank.

6.4 Cleaning the filter drawer

Lint and fiber that could not be captured by the lint filter are blocked in the filter drawer behind the kick plate. Clean the filter periodically when there is visible air collection on it or when the symbol lights up, if there is a filter drawer cleaning warning symbol available.

There is a one stage filter. This one stage filter is made from sponge

To clean the filter drawer:

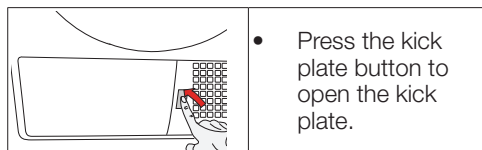

- Press the kick plate button to open the kick plate.

- Open the filter drawer cap turning the cap lock on it and pull it out..

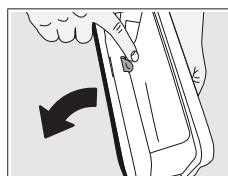
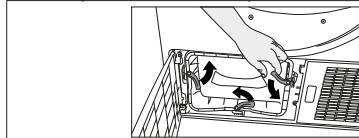

- Open the filter drawer by pressing the red button.

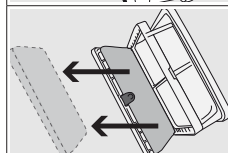

- Take out the filter drawer sponge.

- Clean the fluff and lint over the filter sponge washing it with your hands. Remove the moisture squeezing the sponge with your hands after washing it.
- Clean the fluff, lint and cotton pellets with your hands or with a soft cloth.

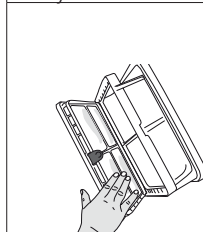

- If you observe a layer over the filter which can block the filter, remove the layer washing with a water and then cleaning it. Dry the filter cloth properly before replacing the filter drawer.



NOTE

- There may be no cloth in the filter cassette of your drying machine, depending on its model.

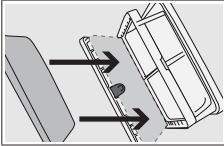

- Place the sponge back into its place.



NOTE

- Please place the sponge carefully inside the frame of the filter cassette shown by arrows in order to avoid squeezing when filter drawer closed”.:

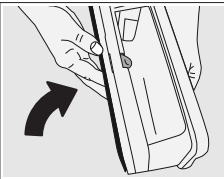

- Close the filter drawer as to lock the red button.

- Replace the filter drawer and tighten the cap turning the filter drawer lock turning it in the arrow direction.

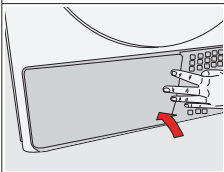
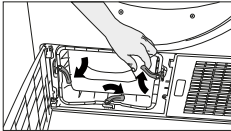

- Close the kick plate cover.



WARNING!

- Drying without the filter drawer sponge in place will damage the machine!



NOTE

- A dirty lint filter and filter drawer will cause longer drying periods and higher energy consumption.

6.5 Cleaning the evaporator

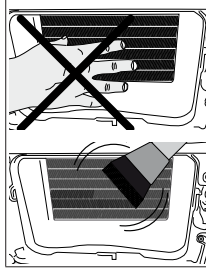

- Clean the lint accumulated on the fins of the evaporator located behind the filter drawer with a vacuum cleaner.



WARNING!

- You can also clean by hand provided that you wear protective gloves. Do not attempt to clean with bare hands. Evaporator fins can harm your hand.

7 Troubleshooting

Drying operation takes too long.

Fibre filter pores might be clogged. >>> Wash the filter with warm water.

Filter drawer might be clogged. >>> Clean the sponge and filter cloth (if any) in the filter drawer. (for the products with a heat pump)

The condenser might be blocked. >>> Wash the condenser.(for the products with a condenser)

The ventilation grills in front of the machine may be closed.

>>> Remove any objects in front of the ventilation grills that blocks air.

Ventilation may be inadequate because the area the machine is installed in is too small. >>> Open the door or windows to prevent the room temperature from rising very high.

A lime layer may have accumulated on the humidity sensor. >>> Clean the humidity sensor.

Excessive amount of laundry might be loaded. >>> Do not load the drying machine excessively.

Laundry might not have been wrung adequately. >>>

Perform a higher speed wringing on the washing machine.

Clothes come out damp after drying.

A program not suitable for the laundry type may have been used.>>> Check the maintenance labels on the clothes and select a program suitable for the clothes' type or use time programs as extra.

Fibre filter pores might be clogged. >>> Wash the filter with warm water.

The condenser might be blocked. >>> Wash the condenser. (for the products with a condenser)

Filter drawer might be clogged. >>> Clean the sponge and filter cloth (if any) in the filter drawer.(For the products with a heat pump)

Excessive amount of laundry might be loaded. >>> Do not load the drying machine excessively.

Laundry might not have been wrung adequately. >>>

Perform a higher speed wringing on the washing machine.

Drying machine does not turn on or program cannot be started. **Drying machine does not run after it is configured.**

Power plug might be unplugged. >>> Make sure the power cord is plugged in.

Loading door might be open. >>> Ensure that the loading door is properly closed.

A program might not be set or Start/Stand-by button might not be pressed. >>> Check that the program is set and it is not in Stand-by position.

Child lock may be activated. >>> Turn off the child lock.

Program terminated prematurely for no reason.

Loading door might not be closed completely. >>> Ensure that the loading door is properly closed.

There might be a power outage. >>> Press the Start/Stand-by button to start the program.

Water tank may be full. >>> Empty the water tank.

Clothes have shrunk, hardened or spoiled.

A program not suitable with the laundry type might have been used. >>> Check the maintenance labels on the clothes and select a program suitable for the clothes.

The lighting inside the drying machine does not turn on. (For models with a lamp).

Drying machine might not be turned on with the On/Off button or program might not be selected for machines without an On/Off button. >>> Make sure that the drying machine is turned on.

Lamp might be malfunctioning. >>> Contact your Authorised Service Agent to replace the lamp.

Filter cleaning warning symbol/LED is on/flashing.

Fibre filter might not be cleaned. >>> Clean the filter.

The filter slot might be clogged with lint. >>> Clean the filter slot.

A layer of fluff might have accumulated clogging up the lint filter pores. >>> Wash the filter with warm water.

The condenser might be blocked. >>> Wash the condenser.

Water drips from the loading door.

Fibres might have gathered on the inner sides of the loading door and the loading door gasket. >>> Clean the inner surfaces of the loading door and the loading door gasket surfaces.

Loading door opens by itself.

Loading door might not be closed completely. >>> Push the loading door until the closing sound is heard.

Water tank warning symbol / led is on/flashing.

Water tank may be full. >>> Empty the water tank.

Water discharge hose might have collapsed. >>> If the product is connected directly to the water drain check the water discharge hose.

Steam symbol is flashing.(For the products with a steam function)

Steam tank may be empty => Fill the steam tank with distilled or condensed water.

Steam programs do not start (For the products with a steam function)

Steam tank may be empty, steam tank warning icon may light up on the screen => Fill the steam tank until the steam icon goes off.

Wrinkles are not removed with wrinkle removing program. (For the products with a steam function)

Excess amount of laundry may have been placed => Place specified amount of laundry.

Steam application time may be selected in low level => Choose a program with high amount of steam.

After completion of the program, the laundry may have stayed in the machine for a long time => Take the laundry out as soon as the program finishes, and hang it out.

Laundry odour not lessened with the odour removal program.(For the products with an odour removal program)

Excess amount of laundry may have been placed => Place specified amount of laundry.

Steam application time may be selected in low level => Choose a program with high amount of steam.



WARNING!

- If the problem persists after following the instructions in this section, contact your vendor or an Authorised Service Agent. Never try to repair your product yourself.



NOTE

- In an event that you encounter an issue on any part on your appliance, you can ask for a replacement by contact the authorised service agent service with the appliance model number.
- Operating the appliance with non-authentic parts may lead the appliance to malfunction.
- Manufacturer and distributor are not liable for malfunctions resulting from using non-authentic parts.

PRODUCT FICHE

Complying Commission Delegated Regulation (EU) No 392/2012

Supplier name or trademark		BEKO
Model name		DPS7405W3 7188232010
Rated capacity (kg)		7.0
Type of Tumble Dryer	Air Vented	-
	Condenser	•
Energy efficiency class ⁽¹⁾		A++
Annual Energy Consumption (kWh) ⁽²⁾		209,0
Type of Control	Automatic	•
	Non-automatic	-
Energy consumption of the standard cotton programme at full load (kWh)		1,68
Energy consumption of the standard cotton programme at partial load (kWh)		0,98
Power consumption of the off-mode for the standart cotton programme at full load, P ₀ (W)		0,50
Power consumption of the left-on mode for the standart cotton programme at full load, P _L (W)		1,00
The duration of the left on mode (min)		30
Standard cotton programme ⁽³⁾		•
Programme time of the standard cotton programme at full load, T _{dry} (min)		174
Programme time of the standard cotton programme at partial load, T _{dry1/2} (min)		107
Weighted programme time of the standard cotton programme at full and partial load (T _w)		136
Condensation efficiency class ⁽⁴⁾		B
Average condensation efficiency of the standard cotton programme at full load, C _{dry}		86%
Average condensation efficiency of the standard cotton programme at partial load, C _{dry1/2}		86%
Weighted condensation efficiency of the standard cotton programme at full load and partial load, C _w		86%
Sound power level for the standard cotton programme at full load ⁽⁵⁾		65
Built-in		-

• : Yes - : No

(1) Scale from A+++ (most efficient) to D (least efficient)

(2) Energy consumption based on 160 drying cycles of the standard cotton programme at full and partial load, and the consumption of the low-power modes. Actual energy consumption per cycle will depend on how the appliance is used.

(3) "Cotton cupboard dry programme" used at full and partial load is the standard drying programme to which the information in the label and the fiche relates, that this programme is suitable for drying normal wet cotton laundry and that it is the most efficient programme in terms of energy consumption for cotton

(4) Scale from G (lest efficient) to A (most efficient)

(5) Weighted average value — L_{WA} expressed in dB(A) re 1 pW

