



**Built-in Oven**  
User Manual



MACK1112BL2

385446249/ EN/ R.AA/ 12.12.2025 16:17  
7754886774



## Welcome!

---

Dear Customer,

Thank you for choosing the Beko product. We want your product, manufactured with high quality and technology, to offer you the best efficiency. Therefore, carefully read this manual and any other documentation provided before using the product.

Keep in mind all the information and warnings stated in the user's manual. This way, you will protect yourself and your product against the dangers that may occur.

Keep the user's manual. If you give the product to someone else, give the manual with it. The warranty conditions, usage and troubleshooting methods for your product are provided in this manual.

### The symbols and their descriptions in the user's manual:



Hazard that may result in death or injury.



Important information or useful usage tips.



Read the user's manual.



Hot surface warning.

**NOTICE**

Hazard that may result in material damage to the product or its environment.

**Arçelik A.Ş.**

Karaağaç caddesi No:2-6  
34445 Söğütözü/İstanbul/TURKEY

Made in TURKEY

## Table of Contents

<b>1 Safety Instructions</b> .....	<b>4</b>	6.1.1 Pastries and oven food.....	31
1.1 Intended Use.....	4	6.1.2 Meat, Fish and Poultry.....	34
1.2 Child, Vulnerable Person and Pet Safety.....	4	6.1.3 Grill.....	35
1.3 Electrical Safety.....	5	6.1.4 Shallow or Oil-Free Frying Function.....	35
1.4 Transportation Safety.....	7	6.1.5 Test foods.....	37
1.5 Installation Safety.....	7	<b>7 Maintenance and Cleaning</b> .....	<b>38</b>
1.6 Safety of Use.....	8	7.1 General Cleaning Information.....	38
1.7 Temperature Warnings.....	8	7.2 Cleaning Accessories.....	39
1.8 Accessory Use.....	9	7.3 Cleaning the Control Panel.....	40
1.9 Cooking Safety.....	9	7.4 Cleaning the inside of the oven (cooking area).....	40
1.10 Maintenance and Cleaning Safety	10	7.5 Easy Steam Cleaning.....	40
<b>2 Environmental Instructions</b> .....	<b>11</b>	7.6 Cleaning the Oven Door.....	41
2.1 Waste Directive.....	11	7.7 Removing the Inner Glass of The Oven Door.....	42
2.1.1 Compliance with the WEEE Directive and Disposing of the Waste Product.....	11	7.8 Cleaning the Oven Lamp.....	42
2.2 Package Information.....	11	<b>8 Troubleshooting</b> .....	<b>43</b>
2.3 Recommendations for Energy Saving.....	11		
<b>3 Your product</b> .....	<b>12</b>		
3.1 Product Introduction.....	12		
3.2 Product Control Panel Introduction and Usage.....	12		
3.2.1 Control Panel.....	13		
3.2.2 Introduction of the oven control panel.....	13		
3.3 Oven operating functions.....	14		
3.4 Product Accessories.....	15		
3.5 Use of Product Accessories.....	15		
3.6 Technical Specifications.....	18		
<b>4 First Use</b> .....	<b>19</b>		
4.1 First Timer Setting.....	19		
4.2 Initial Cleaning.....	19		
<b>5 Using the Oven</b> .....	<b>20</b>		
5.1 General Information on Using the Oven.....	20		
5.2 Operation of the Oven Control Unit.....	20		
5.3 Settings.....	25		
<b>6 General Information About Cooking</b> .....	<b>30</b>		
6.1 General Warnings About Baking in the Oven.....	31		

## 1 Safety Instructions

---

- This section includes the safety instructions necessary to prevent the risk of personal injury or material damage.
- If the product is handed over to someone else for personal use or second-hand use purposes, the user's manual, product labels and other relevant documents and parts should also be given.
- Our company shall not be held responsible for damages that may occur if these instructions are not observed.
- Failure to follow these instructions shall void any warranty.
- Always have the installation and repair works made by the manufacturer, the authorised service or a person that the importer company shall designate.
- Use original spare parts and accessories only.
- Do not repair or replace any component of the product unless it is clearly specified in the user's manual.
- Do not make technical modifications on the product.

### 1.1 Intended Use

- This product is designed to be used at home. It is not suitable for commercial use.
- Do not use the product in gardens, balconies or other outdoors. This product is intended to be used in households and in the staff kitchens of shops, offices and other working environments.
- **CAUTION:** This product should be used for cooking purposes only. It should not be used for different purposes, such as heating the room.
- The oven can be used to defrost, bake, fry and grill food.
- This product should not be used for plate heating, drying by hanging towels or clothes on the handle.

### 1.2 Child, Vulnerable Person and Pet Safety

- This product can be used by children 8 years of age and older, and people who are underdeveloped in physical, sensory or mental skills, or who have lack of experience and knowledge, as long as they are

- supervised or trained about the safe use and hazards of the product.
- Children should not play with the product. Cleaning and user maintenance should not be performed by children unless there is someone overseeing them.
  - This product should not be used by people with limited physical, sensory or mental capacity (including children), unless they are kept under supervision or receive the necessary instructions.
  - Children should be supervised to ensure that they do not play with the product.
  - Electrical products are dangerous for children and pets. Children and pets must not play with, climb on, or enter the product.
  - Do not put objects that children may reach on the product.
  - **CAUTION:** During use, the accessible surfaces of the product are hot. Keep children away from the product.
  - Keep the packaging materials out of the reach of children. There is a hazard of injury and suffocation.
- When the door is open, do not put any heavy objects on it or allow children to sit on it. You may cause the oven to tip over or damage the door hinges.
  - Before discarding worn out and useless products:
    1. Unplug the power plug and remove it from the socket.
    2. Cut off the power cable and disconnect it with the plug from the product.
    3. Take precautions to prevent children from entering the product.
    4. Do not allow children to play with product when it is in idle mode.



### 1.3 Electrical Safety

- Plug the product into a grounded outlet protected by a fuse that matches the current ratings indicated on the type label. Have the grounding installation made by a qualified electrician. Do not use the product without grounding in accordance with local / national regulations.
- The plug or the electrical connection of the appliance shall be in an easily accessible place. If this is not possible, there should be a mechanism (fuse, switch, key switch, etc.) on the electrical installation to

which the product is connected, in compliance with the electrical regulations and separating all poles from the network.

- Unplug the product or switch off the fuse before repair, maintenance and cleaning.
  - Plug the product into an outlet that meets the voltage and frequency values specified on the type label.
  - (If your product does not have a mains cable) only use the connecting cable described in the "Technical specifications" section.
  - Do not jam the power cable under and behind the product. Do not put a heavy object on the power cable. The power cable should not be bent, crushed, and come into contact with any heat source.
  - Make sure that the power cable is not jammed while putting the product to its place after assembly or cleaning.
  - The rear surface of the oven gets hot when it is in use. The power cables must not touch the rear surface of the product. Otherwise it might get damaged.
  - Do not jam the electric cables into the oven door and do not pass them over hot surfaces.
- Otherwise, cable insulation may melt and cause fire as a result of short circuit.
- Use original cable only. Do not use cut or damaged cables.
  - Do not use an extension cord or multi-plug to operate your product.
  - Contact the authorized service centre or importer to use the approved adapter in cases where the use of a converter adapter (for plug type) is necessary.
  - Contact the importer or the authorized service centre if the length of the power line is inadequate.
  - Portable power sources or multiple plugs may overheat and catch fire. Keep multiple plugs and portable power sources away from the product.
  - If the power cable is damaged, it must be replaced by the manufacturer, an authorized service or a person to be specified by the importer company in order to prevent possible dangers.
  - **CAUTION:** Before replacing the oven lamp, be sure to disconnect the product from the mains supply to avoid the risk

of electric shock. Unplug the product or turn off the fuse from the fuse box.

If your product has a power cable and plug:

- Never put the product plug into a broken, loose, or out-of-socket plug. Make sure the plug is fully inserted into the socket. Otherwise the connections may overheat and cause a fire.
- Avoid inserting the device into plugs that are greasy, unclean, or potentially exposed to water (such as those near a worktop where water may escape). Otherwise there is a risk of short circuit and electrocution.
- Never touch the plug with wet hands!
- Pull the plug out of the socket using the plug's body rather than the cord itself.

#### **1.4 Transportation Safety**

- Disconnect the product from the mains before transporting the product.
- The product is heavy, carry the product with at least two people.
- Do not use the door and / or handle to transport or move the product.

- Do not place items on the appliance. Carry the appliance vertically.
- When you need to transport the product, wrap it with bubble wrap packaging material or thick cardboard and tape it tightly. Secure the moving parts of the product firmly to prevent damage.
- Before the product is installed, check the product for any damage after transport. Contact the importer or the authorized service centre if damaged.

#### **1.5 Installation Safety**

- Before beginning the installation, de-energize the power line to which the product will be connected by turning off the fuse.
- Always wear protective gloves during transport and installation. Otherwise there is a risk of injury from sharp edges!
- Before the product is installed, check the product for any damage. Do not have it installed if the product is damaged.
- Avoid using any heat-insulating materials to cover the interior of the furniture that will be installed.

- Direct sunlight and heat sources, such as electric or gas heaters, must not be present in the area where the product is installed.
- Keep the surroundings of all ventilation ducts of the product open.
- To avoid overheating, product installation should not be carried out behind decorative covers.
- In cases where a gas hose/ pipe or plastic water pipe is situated behind the designated installation area for the product, it is imperative to guarantee that there is no contact between the product and these utility lines. Otherwise the hose/pipe may be crushed.
- If there is a socket behind the place where the product will be installed, it must be ensured that the product does not come into contact with the socket nor with the plug plugged into the socket.
- Don't use the product if it breaks down or gets damaged while being used. Disconnect the product from the electricity. Contact the importer or the authorized service centre.
- Do not use the product if the front door glass is removed or cracked. Otherwise there is a risk of injury and environmental damage.
- Do not step on the appliance for any reason.
- Never use the product when your judgement or coordination is impaired by the use of alcohol and/or drugs.
- Flammable objects must not be kept in and around the cooking area. Otherwise, these may lead to fire.
- The oven handle is not a towel dryer. When using the product, do not hang towels, gloves or similar textiles on the handle.
- The hinges of the product door move when opening and closing the door and might jam. When opening / closing the door, do not hold the part with the hinges.

## 1.6 Safety of Use

- Ensure that the appliance is switched off after every use.
- If you will not use the product for a long time, unplug it or turn off the power from the fuse box.

## 1.7 Temperature Warnings

- **CAUTION:** When the product is in use, the product and its accessible parts will be hot. Care

should be taken to avoid touching the product and heating elements. Children under 8 years of age should be kept away from the product unless constantly supervised.

- Do not place flammable / explosive materials near the product, as the surfaces will be hot while it is operating.
- Keep your distance when opening the oven door during or at the end of cooking. The steam may burn your hand, face and/or eyes.
- During operation the product is hot. Care should be taken to avoid touching hot parts, inside of the oven and heating elements.
- Always wear heat-resistant oven gloves when handling the product.

### 1.8 Accessory Use

- It is important to use the accessories provided with the product appropriately. For detailed information, refer to the section "**Use of Product Accessories**".
- Close the oven door after pushing the accessories completely into the cooking space, otherwise they may hit the door glass and damage it.

### 1.9 Cooking Safety

- Be careful when using alcoholic drinks in your dishes. Alcohol evaporates at high temperatures and may cause fire since it can ignite when it comes into contact with hot surfaces.
  - Food residues in the cooking area., such as oil, can ignite. Clean these residues before cooking.
  - Food Poisoning Hazard: Do not let food sit in oven for more than 1 hour before or after cooking. Otherwise it may cause food poisoning or diseases.
  - Do not heat closed tins and glass jars in the oven. The pressure that would build-up in the tin/jar may cause it to burst.
  - When the oven is in use, NEVER place baking tray, dishes or aluminium foil directly on the bottom of the oven. The heat accumulation might damage the bottom of the oven, and might even cause damage to the oven cabinet or kitchen flooring.
- Be mindful of the following precautions when using greasy parchment paper or similar materials:

- Place the greaseproof paper in a cookware or on the oven accessory (tray, wire grill, etc.) with food and place it in the preheated oven.
- To prevent the risk of touching the oven heating elements and obstructing the flow of hot air, remove any excess parts of greaseproof paper that hang from accessories or containers. Do not use greaseproof paper at oven temperatures higher than the maximum usage temperature specified by the manufacturer. Never place greaseproof paper on the oven base.
- Do not place it on top of accessories during preheating.
- Always press down with a plate or similar object to prevent the material from flying around due to the air circulation inside the oven.
- Only cover the necessary surface inside the tray.
- After each use, the tray should be cleaned, and any greaseproof paper or similar materials used in the tray should be replaced. Otherwise, liquids dripping onto the tray can cause smoking or even ignite flames.
- An air flow is generated when the product lid is opened. Greaseproof paper can come into contact with heating elements and ignite.
- When using wire grill, a tray should be placed on the lower rack. Otherwise, the food oil and other components that drip onto the oven bottom can create heavy smoke and lead to flames.
- Close the oven door during grilling. Hot surfaces may cause burns!
- Food not suitable for grilling carries a fire hazard. Grill only food that is suitable for heavy grill fire. Do not place the food too far in the back of the grill. This is the hottest area and fatty foods may catch fire.



### **1.10 Maintenance and Cleaning Safety**

- Wait for the product to cool before cleaning the product. Hot surfaces may cause burns!
- Never wash the product by spraying or pouring water on it! There is the risk of electric shock!
- Do not use steam cleaners to clean the product as this may cause an electric shock.

- Do not use harsh abrasive cleaners, metal scrapers, wire wool or bleach materials to clean the oven front door

glass. These materials can cause glass surfaces to be scratched and broken.

## 2 Environmental Instructions

---

### 2.1 Waste Directive

#### 2.1.1 Compliance with the WEEE Directive and Disposing of the Waste Product

This product complies with EU WEEE Directive (2012/19/EU). This product bears a classification symbol for waste electrical and electronic equipment (WEEE).



This product has been manufactured with high quality parts and materials which can be re-used and are suitable for recycling. Therefore, do not dispose

of the waste product with normal domestic and other wastes at the end of its service life. Take it to a collection point for the recycling of electrical and electronic equipment. You can ask your local administration about these collection points. Disposing of the appliance properly helps prevent negative consequences for the environment and human health.

#### Compliance with RoHS Directive:

The product you have purchased complies with EU RoHS Directive (2011/65/EU). It does not contain harmful and prohibited materials specified in the Directive.

### 2.2 Package Information

Packaging materials of the product are manufactured from recyclable materials in accordance with our National Environment Regulations. Do not dispose of the pack-

aging waste with the household or other wastes, take it to the packaging material collection points designated by the local authorities.

### 2.3 Recommendations for Energy Saving

According to EU 66/2014, information on energy efficiency can be found on the product receipt supplied with the product. The following suggestions will help you use your product in an ecological and energy-efficient way:

- Defrost frozen food before baking.
- In the oven, use dark or enamelled containers that transmit heat better.
- If specified in the recipe or user's manual, always preheat. Do not open the oven door frequently during baking.
- Turn off the product 5 to 10 minutes before the end time of baking in prolonged bakings. You can save up to 20% electricity by using residual heat.
- Try to cook more than one dish at a time in the oven. You may cook at the same time by placing two cookers on the wire rack. In addition, if you cook your meals one after the other, it will save energy because the oven will not lose its heat.
- Do not open the oven door when baking in the "Eco fan heating" operating function. If the door is not opened, the internal temperature is optimized to save energy in the "Eco fan heating" operating function, and this temperature may differ from what is shown on the display.

## 3 Your product

### 3.1 Product Introduction

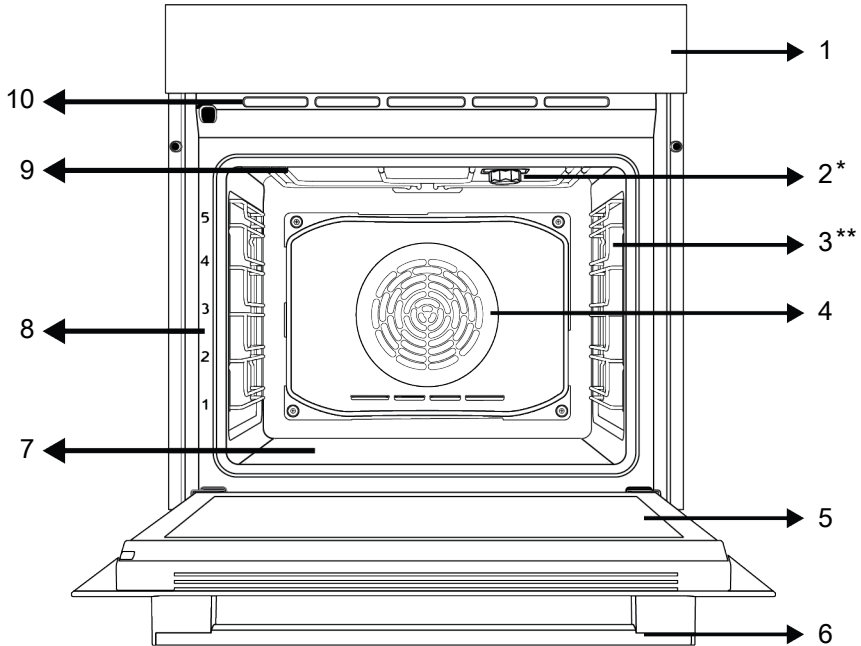

1 Control panel

3 Wire shelves

5 Door

7 Lower heater (under the steel plate)

9 Upper heater

2 Lamp

4 Fan motor (behind the steel plate)

6 Handle

8 Shelf positions

10 Ventilation holes

\* Varies depending on the model. Your product may not be equipped with a lamp, or the type and location of the lamp may differ from the illustration.

\*\* Varies depending on the model. Your product may not be equipped with a wire rack. In the image, a product with wire rack is shown as an example.

### 3.2 Product Control Panel Introduction and Usage

In this section, you can find the overview and basic uses of the product's control panel. There may be differences in images and some features depending on the type of product.

### 3.2.1 Control Panel

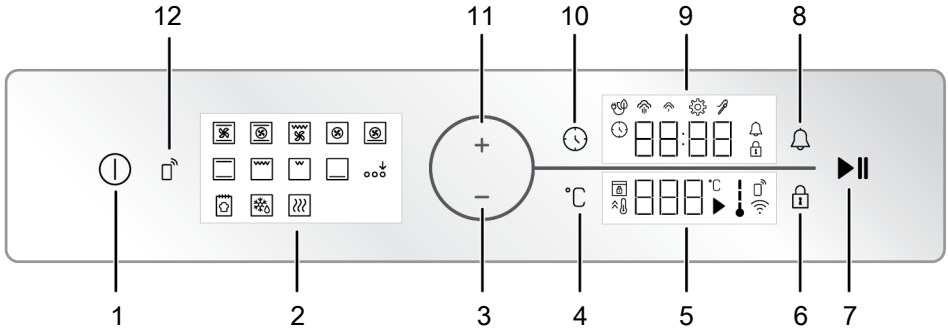

- 1 On/off key
- 2 Function display
- 3 Decrease key
- 4 Temperature setting key
- 5 Temperature indicator area
- 6 Key lock key
- 7 Baking start/stop key
- 8 Alarm key
- 9 Timer/duration indicator area
- 10 Time and settings key
- 11 Increase key

If there are knob(s) controlling your product, in some models this/these knob(s) may be so that they come out when pushed (buried knobs). For settings to be made with these knobs, first push the relevant knob in and pull out the knob. After making your adjustment, push it in again and replace the knob.

### 3.2.2 Introduction of the oven control panel

#### Oven inner temperature indicator

You can understand the oven inner temperature from the inner temperature symbol on the display. When the cooking starts, the symbol is seen on the display and when the oven inner temperature reaches the set temperature, each level of the symbol illuminates.

#### Function display

Working functions of your oven are located at the function display on your oven. Each function is activated by touching it. All functions located on the display are schematic, they may not be present in your appli-

ance. Functions of your product are described in the section titled “Oven operating functions”.

#### Indicator areas:

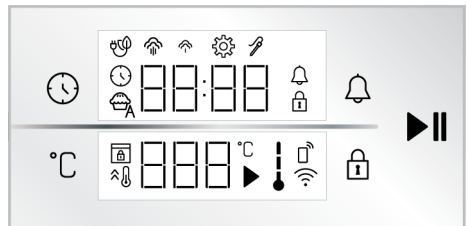

#### Keys :

- : Time and settings key
- : Temperature setting key
- : Key lock key
- : Alarm key
- : Baking start/stop key

#### Timer/duration indicator area :

- : Baking time/time of day symbol
- : Alarm symbol
- : Settings symbol
- : Key lock symbol
- : Symbol of baking with eco fan

 : Low level steam symbol \*

 : High level steam symbol \*

 : Meat probe symbol \*

\* It varies depending on the product model. It may not be available on your product.

**Temperature indicator area :**

 : Baking symbol

 : Temperature symbol

 : In-oven temperature symbol

 : Quick heating (booster) symbol

 : Door lock symbol \*









 : Remove control symbol \*





 : Wifi symbol \*

\* : It varies depending on the product model. It may not be available on your product.

### 3.3 Oven operating functions

On the function table, the operating functions you can use in your oven and the highest and lowest temperatures that can be set for these functions are shown. The order of the operating modes shown here may differ from the arrangement on your product.

Function symbol	Function description	Temperature range (°C)	Description and use
	Operating with fan	-	The oven is not heated. Only the fan (on the back wall) operates. Frozen food with granules is slowly defrosted at room temperature, cooked food is cooled. The time required to defrost a whole piece of meat is longer than for foods with grains.
	Top and bottom heating	40-280	Food is heated from above and below at the same time. Suitable for cakes, pastries or cakes and stews in baking moulds. Cooking is done with a single tray.
	Bottom heating	40-220	Only lower heating is on. It is suitable for foods that need browning on the bottom. This function should also be used for easy steam cleaning.
	Fan assisted bottom/top heating	40-280	The hot air heated by the upper and lower heaters is distributed equally and rapidly throughout the oven with the fan. Cooking is done with a single tray.
	Fan Heating / Airfry	40-280	The hot air heated by the fan heater is distributed equally and rapidly throughout the oven with the fan. It is suitable for multi-tray cooking at different shelf levels. Thanks to the rapidly distributed air by this function, you can make shallow or oil-free frying. For detailed information, see the "Airfry" section.
	Eco fan heating	160-220	In order to save energy, you can use this function instead of using "Fan Heating" in the range of 160-220°C. But; cooking time will be slightly longer. The use of this function is explained at the section titled "Operation of oven control unit".
	Pizza function	40-280	The lower heater and fan heating work. It is suitable for cooking pizza.
	"3D" function	40-280	Upper heating, lower heating and fan heating functions operate. Each side of the product to be cooked is cooked equally and quickly. Cooking is done with a single tray.
	Low grill	40-280	The small grill on the oven ceiling works. It is suitable for grilling smaller amounts.

	Full grill	40-280	The large grill on the oven ceiling works. It is suitable for grilling in large amounts.
	Fan assisted full grill	40-280	The hot air heated by the large grill is quickly distributed into the oven with the fan. It is suitable for grilling in large amounts.
	Keep warm	40-100	It is used to keep the food at a temperature ready for service for a long time.
	Bread function	-	It is used to bake bread. Incoming set temperature and time may not be changed.
	Extra function activation	-	It is used to activate operation functions which do not show up at the start on the function display.

### 3.4 Product Accessories

There are various accessories in your product. In this section, the description of the accessories and the descriptions of the correct usage are available. Depending on the product model, the supplied accessory varies. All accessories described in the user's manual may not be available in your product.



The trays inside your appliance may be deformed with the effect of the heat. This has no effect on the functionality. Deformation disappears when the tray is cooled.

#### Standard tray

It is used for pastries, frozen foods and frying large pieces.

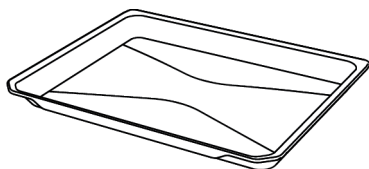

#### Wire grill

It is used for frying or placing the food to be baked, fried and stewed on the desired shelf.

#### On models with wire shelves :

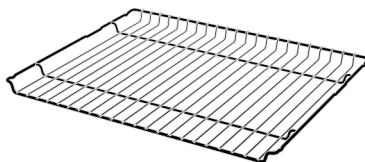

#### On models without wire shelves :

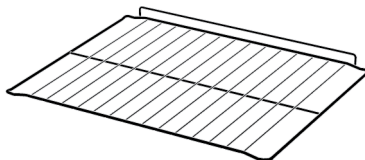

#### Barrier coated frying tray (Airfry)

Used for shallow or oil-free frying of foods. The barrier coated oven tray has less adhesion than other trays.

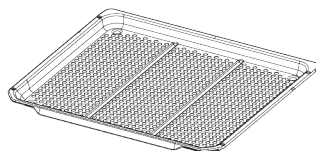

### 3.5 Use of Product Accessories

#### Cooking shelves

There are 5 levels of shelf position in the cooking area. You can also see the order of the shelves in the numbers on the front frame of the oven.

**On models with wire shelves :**

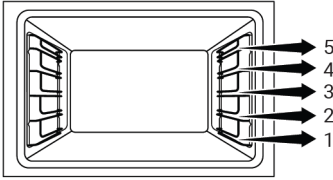

**On models without wire shelves :**

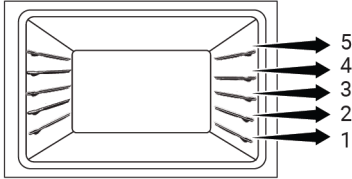

**Placing the wire grill on the cooking shelves**

**On models with wire shelves :**

It is crucial to place the wire grill on the wire side shelves properly. While placing the wire grill on the desired shelf, the open section must be on the front. For better cooking, the wire grill must be secured on the wire shelf's stopping point. It must not pass over the stopping point to contact with the rear wall of the oven.

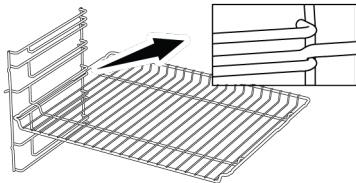

**On models without wire shelves :**

It is crucial to place the wire grill on the side shelves properly. The wire grill has one direction when placing it on the shelf. While placing the wire grill on the desired shelf, the open section must be on the front.

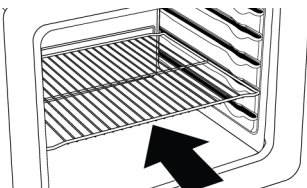

**Placing the tray on the cooking shelves**

**On models with wire shelves :**

It is also crucial to place the trays on the wire side shelves properly. While placing the tray on the desired shelf, its side designed for holding must be on the front. For better cooking, the tray must be secured on the stopping socket on the wire shelf. It must not pass over the stopping socket to contact with the rear wall of the oven.

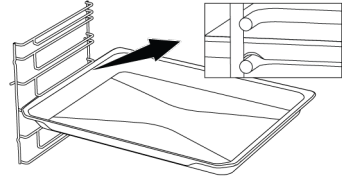

**On models without wire shelves :**

It is also crucial to place the trays on the side shelves properly. The tray has one direction when placing it on the shelf. While placing the tray on the desired shelf, its side designed for holding must be on the front.

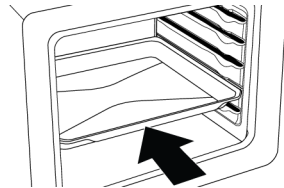

**Stopping function of the wire grill**

There is a stopping function to prevent the wire grill from tipping out of the wire shelf. With this function, you can easily and safely take out your food. While removing the wire grill, you can pull it forward until it reaches the stopping point. You must pass over this point to remove it completely.

**On models with wire shelves :**

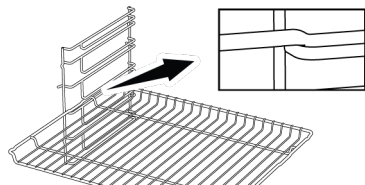

**On models without wire shelves :**

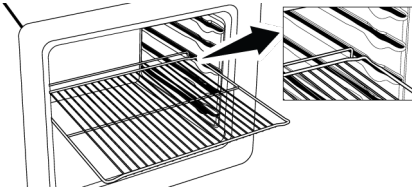

**Tray stopping function - On models with wire shelves**

There is also a stopping function to prevent the tray from tipping out of the wire shelf. While removing the tray, release it from the rear stopping socket and pull it towards yourself until it reaches the front side. You must pass over this stopping socket to remove it completely.

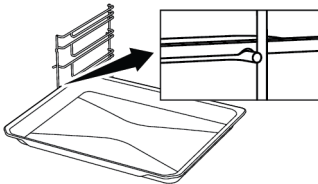

**Proper placement of the wire grill and tray on the telescopic rails-On models with wire shelves and telescopic models**

Thanks to telescopic rails, trays or the wire grill can be easily installed and removed. When using trays and wire grills with the telescopic rail, care should be taken that the pins on the front and back of the telescopic rails, rest against the edges of the grill and the tray (shown in the figure).

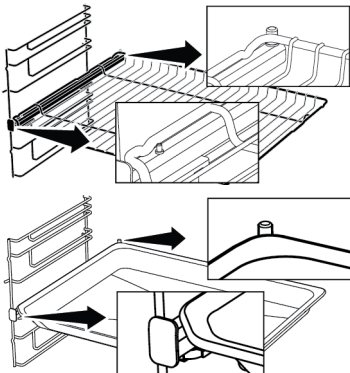

### 3.6 Technical Specifications

General specifications	
Product external dimensions (height/width/depth) (mm)	595 /594 /567
Oven installation dimensions (height / width / depth) (mm)	590-600 /560 /min. 550
Voltage/Frequency	220-240 V ~; 50 Hz
Cable type and section used/suitable for use in the product	min. H05VV-FG 3 x 1,5 mm <sup>2</sup>
Total power consumption (kW)	3,3
Oven type	Multifunction oven

Basics: Information on the energy label of electrical ovens is given in accordance with the EN 60350-1 / IEC 60350-1 standard. Those values are determined under standard load with bottom-top heater or fan assisted heating (if any) functions.

Energy efficiency class is determined in accordance with the following prioritization depending on whether the relevant functions exist on the product or not: 1-Eco fan heating , 2-Fan Heating , 3-Fan assisted low grill , 4-Top and bottom heating.



Technical specifications may be changed without prior notice to improve the quality of the product.



Figures in this manual are schematic and may not exactly match your product.



Values stated on the product labels or in the documentation accompanying it are obtained in laboratory conditions in accordance with relevant standards. Depending on operational and environmental conditions of the product, these values may vary.

## 4 First Use



Before you start using your product, it is recommended to do the following stated in the following sections respectively.

### 4.1 First Timer Setting

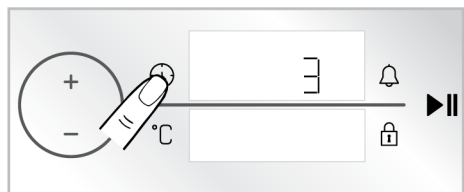

**i** Always set the time of day before using your oven. If you do not set it, you cannot cook in some oven models.

1. With the oven turned off (while the time of day appears on the display), touch the  key for about 3 seconds to activate the settings menu.
  - ⇒ A countdown of 3-2-1 appears on the display. When the countdown is over, the settings menu is activated.



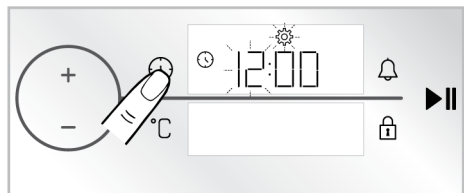

2. Touch the  key once to activate the timer field.
  - ⇒ The timer field and the  symbol flash on the timer/duration display.

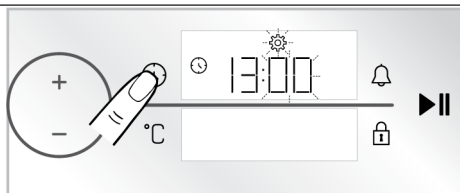

3. Set the time of day by touching the **+**/**-** keys and activate the minutes field by touching the  key once.
  - ⇒ The minutes field and the  symbol flash on the timer/duration display.



4. Touch the **+**/**-** keys to set the minute. Confirm the setting by touching the  key once.
    - ⇒ The time of day is set and the  symbol illuminates continuously.
- i** If the first timer setting is not performed, the time of day starts from the time set at the production process. You can change the time of day setting later as described in the “Settings” section.

**i** In the event of a long power outage, the time of day setting is cancelled. It should be set again.

### 4.2 Initial Cleaning

1. Remove all packaging materials.
2. Remove all accessories from the oven provided with the product.
3. Operate the product for 30 minutes and then, turn it off. This way, residues and layers that may have remained in the oven during production are burned and cleaned.
4. When operating the product, select the highest temperature and the operating function that all the heaters in your product operate. See “Oven operating functions”. You can learn how to operate the oven in the following section.
5. Wait for the oven to cool.
6. Wipe the surfaces of the product with a wet cloth or sponge and dry with a cloth.

#### Before using the accessories:

Clean the accessories you remove from the oven with detergent water and a soft cleaning sponge.

**NOTICE:** Some detergents or cleaning agents may cause damage to the surface. Do not use abrasive detergents, cleaning powders, cleaning creams or sharp objects during cleaning.

**NOTICE:** During the first use, smoke and odour may come up for several hours. This is normal and you just need good ventilation to remove it. Avoid directly inhaling the smoke and odours that form.

## 5 Using the Oven

---

### 5.1 General Information on Using the Oven

**Cooling fan ( It varies depending on the product model. It may not be available on your product. )**

Your product has a cooling fan. The cooling fan is activated automatically when necessary and cools both the front of the product and the furniture. It is automatically deactivated when the cooling process is finished. Hot air comes out over the oven door. Refrain from covering these ventilation openings. Otherwise, the oven may overheat. The cooling fan continues to operate during oven operation or after the

oven is turned off (approximately 20-30 minutes). If you cook by programming the oven timer, at the end of the baking time, the cooling fan turns off with all functions. The cooling fan running time cannot be determined by the user. It turns on and off automatically. This is not an error.

#### Oven lighting

The oven lighting is turned on when the oven starts baking. In some models, the lighting is on during baking, while in some models it turns off after a certain time. If the product door is opened while the oven is operating or in the closed position, the oven lighting turns on automatically.

### 5.2 Operation of the Oven Control Unit

#### General warnings for the oven control unit

- The maximum time that can be set for the baking process is 5:59 hours. In keeping warm function, this time is 23:59 hours. In case of a power outage, the pre-set baking and baking duration are cancelled.
- While making any adjustments, the relevant symbols flash on the display. It is necessary to save the settings made, either by touching the relevant key in the description or by waiting for a short time.

- If baking time is set when baking starts, the remaining time is shown on the display.
- If the quick preheating setting is active on the control unit the  symbol appears on the display when you start baking and the oven reaches the temperature you set for baking quickly. For quick preheating setting, see the “**Settings**” section.

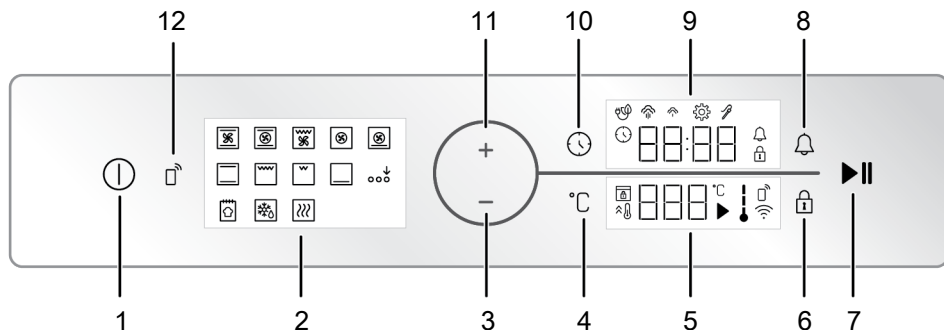

- 1 On/off key
- 2 Function display
- 3 Decrease key
- 4 Temperature setting key
- 5 Temperature indicator area
- 6 Key lock key
- 7 Baking start/stop key
- 8 Alarm key
- 9 Timer/duration indicator area
- 10 Time and settings key
- 11 Increase key
- 12 Remove control key

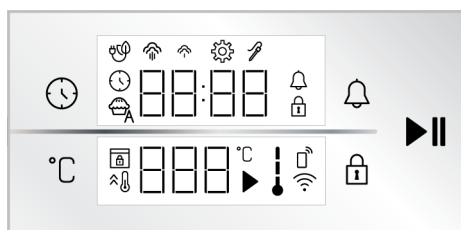

**Keys :**

- : Time and settings key
- : Temperature setting key
- : Key lock key
- : Alarm key

**▶||** : Baking start/stop key

**Timer/duration indicator area :**

- : Baking time/time of day symbol
- : Alarm symbol
- : Settings symbol
- : Key lock symbol
- : Symbol of baking with eco fan
- : Low level steam symbol \*
- : High level steam symbol \*
- : Meat probe symbol \*

\* It varies depending on the product model. It may not be available on your product.

**Temperature indicator area :**

- : Baking symbol
- : Temperature symbol
- : In-oven temperature symbol
- : Quick heating (booster) symbol
- : Door lock symbol \*
- : Remove control symbol \*
- : Wifi symbol \*

\* : It varies depending on the product model. It may not be available on your product.

**Turning on the oven**

1. Turn on the oven by touching the key.
  - ⇒ After the oven is turned on, the first operating function is shown on the display. The operating function, temperature, baking time and alarm can be adjusted when the display is in this status.

If no setting is made on this display, the oven turns off in approximately 5 minutes and the time of day is shown on the display.

**Turning off the oven**

Turn off the oven by touching the key. The time of day is shown on the display.

## Manual baking by selecting temperature and oven operating function

You can cook by making a manual control (at your own control) without setting the baking time by selecting the temperature and operating function specific to your food. As an example, the "Top and bottom heating" function and 180 °C settings are shown in the pictures.

1. Turn on the oven by touching the  key.
2. Touch the operating function you want to activate on the function display.

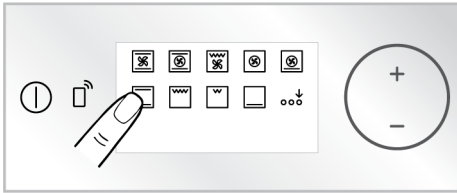

3. If the function you want to activate is not among the operating functions that appear first on the function display, you can activate the operating functions in the lower row by touching "Extra function activation"

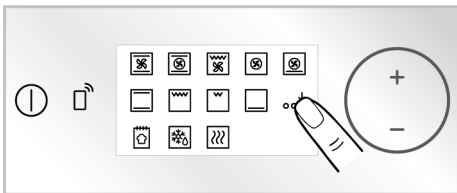

4. The pre-set temperature for the operating function you selected appears on the display. Touch the °C key to change this temperature.

⇒ The °C symbol flashes on the temperature display.

5. Set your desired baking temperature by touching the +/− keys.

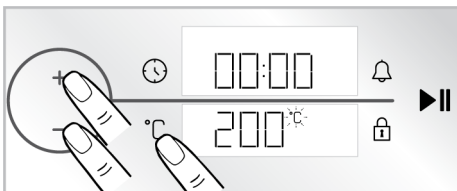

 If you change the operating function after you change the pre-set temperature of the operating function, the last temperature set is shown on the display. However, if the selected temperature is not within the temperature range of the selected operating function, the highest temperature for that operating function is displayed.

6. Confirm the set temperature by touching the °C key.

⇒ The °C symbol lights up continuously on the temperature display.

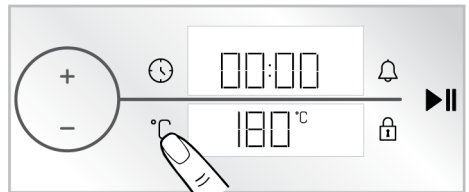

7. After setting up operating function and the temperature touch the ►|| key to start baking.

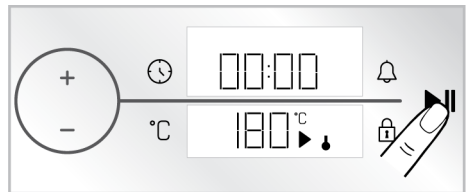

⇒ Your oven will start operating immediately at the selected function and temperature. On the temperature display, the ↓ and ► symbols are shown. Baking time starts counting up on the display. As the oven inner temperature reaches the set temperature, each stage of the ↓ symbol will light up. The oven does not switch off automatically since manual baking is done without setting the baking time. You have to control baking and turn it off yourself. When the baking is completed touch the ►|| key to end the baking or touch the  key to turn off the oven completely.

## Baking by setting the baking time;

You can have the oven turn off automatically at the end of the time by selecting the temperature and operating function specific to your food and setting the baking time on the timer. As an example, the "Top and bottom heating" function, 180 °C and 45 minutes baking time settings are shown in the pictures.

1. Turn on the oven by touching the  key.
2. Touch the operating function you want to activate on the function display.

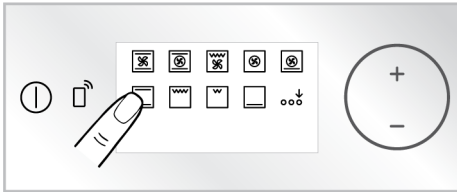

3. If the function you want to activate is not among the operating functions that appear first on the function display, you can activate the operating functions in the lower row by touching "Extra function activation"

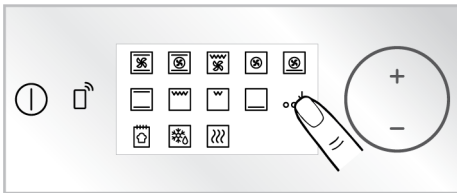

4. The pre-set temperature for the operating function you selected appears on the display. Touch the °C key to change this temperature.

⇒ The °C symbol flashes on the temperature display.

5. Set your desired baking temperature by touching the +/− keys.

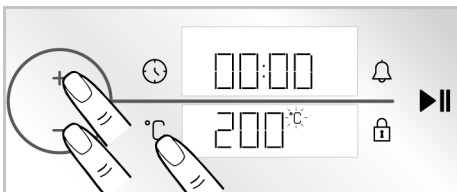



 If you change the operating function after you change the pre-set temperature of the operating function, the last temperature set is shown on the display. However, if the selected temperature is not within the temperature range of the selected operating function, the highest temperature for that operating function is displayed.

6. Confirm the set temperature by touching the °C key.

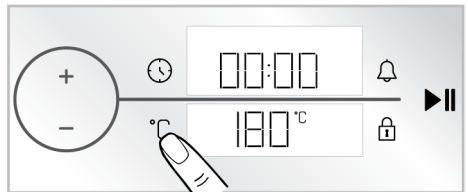

⇒ The °C symbol lights up continuously on the temperature display.

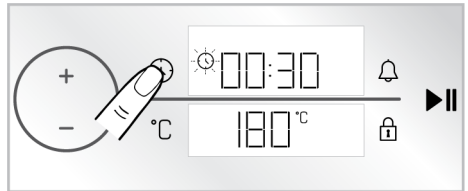

7. Touch the  key once for the baking time.

⇒ The set 30 minutes value appears on the timer/duration display and the  symbol flashes.



 To adjust the baking time quickly, you can activate the baking time as 30 minutes by pushing the oven control knob or touching the  key after the operating function and temperature are set, and you can change the time by turning the oven control knob to the right/left.

8. Set the baking time by touching +/− keys. Confirm the setting by touching the  key.

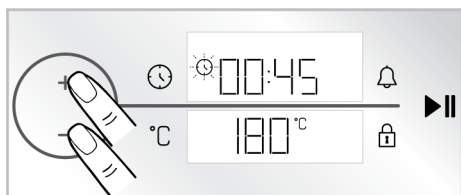

**i** The baking time increases by 1 minute in the first 15 minutes and by 5 minutes after 15 minutes.

9. After setting up operating function, the temperature and the baking time, touch the ►|| key to start baking.



⇒ Your oven starts operating immediately at the selected operating function and temperature and the baking time countdown appears on the display. On the temperature display, the ↓ and ► symbols are shown. As the oven inner temperature reaches the set temperature, each stage of the ↓ symbol will light up. When the adjusted baking time is completed, “End” text appears on the temperature display, the timer gives an audible warning and baking stops.

10. The warning sounds for one minute. If you touch the ►|| key while the audible warning is given and the “End” text is displayed on the temperature display, the oven continues operating indefinitely. The oven is turned off if the ⓪ key is touched. If any key is touched except for these, the audible warning stops.

### Eco fan heating

In order to save energy, you can use this function instead of using “Fan Heating” in the range of 160-220°C. But; baking time will be slightly longer.

1. Turn the oven on by touching the ⓪ key.
2. Touch and hold the “Fan Heating” operation function on the function display for 3 seconds.

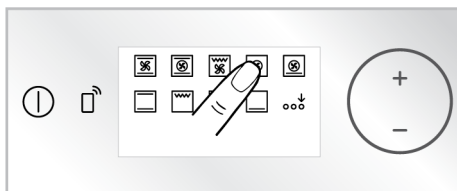

⇒ A countdown of 3-2-1 appears on the display. When the countdown is over, the ♻️ symbol appears on the timer/duration display and the “Eco fan heating” function is activated.

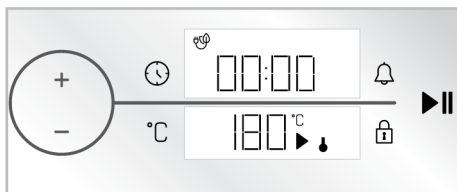

3. You can change the set temperature and set the baking time as described in the previous sections. Then you can start baking.
- ⇒ In “Eco fan heating” mode, the lamp lights up shorter than the other baking function due to energy saving while baking.

### Bread function

Your oven has a “Bread function” defined specifically for bread making. The temperature and time settings of the function are unchangeable.

#### Ingredients

- 500 g flour
- 15 g sugar
- 10 g instant yeast
- 10 g sunflower seed oil
- 8 g salt
- 300 ml water (35°C)

#### For the top of the dough

- 2 teaspoon sunflower oil

## Preparation

1. Sift the flour into a deep container. Add sugar to the flour and mix it homogeneously.
2. Make a well in the middle of the flour, add the yeast, salt and sunflower oil. Warm water is poured gradually, starting from the sides of the container.
3. Knead the dough by hand or in a dough kneading machine for about 10-15 minutes.
4. Turn the dough, which has been kneaded, a few times by hand and put it in a container. Apply 1 teaspoon of sunflower oil on the dough and cover with cling film so that it contacts the dough.
5. After covering your dough with cling film, cover it with a thick cloth and leave it to ferment at room temperature.
6. Take your dough, which has been fermented for 60 minutes, on the counter and fold it 4-5 times to remove the air inside. Apply 1 teaspoon of sunflower oil on the dough and cover with cling film so that it contacts the dough. Let the dough rise for another 30 minutes at room temperature.
7. Place the oven tray on the 3rd shelf of your oven.
8. Turn the oven on by touching the  key.
9. Activate the lower row operating functions by touching the "Extra function activation" on the function display.

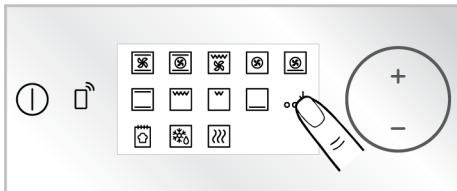

10. Touch "Bread function" on the function display.

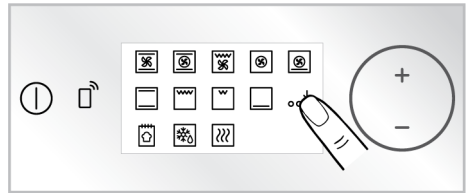

11. Start baking by touching the  key.

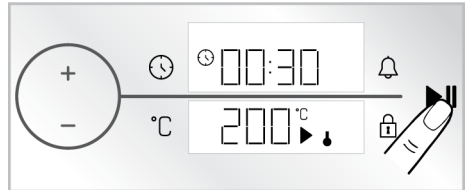

12. At the end of the baking time, an audible warning is given for one minute. If the  key is touched, the oven will turn off. If any key is touched except for these, the audible warning stops.



## 5.3 Settings





The 3-2-1 countdown is shown on the display in the menus or settings that should be activated by pressing for a long period. When the count down expires, the relevant menu or setting is activated.

### Activating the key lock

By using the key lock feature, you can safeguard the interference of the control unit.

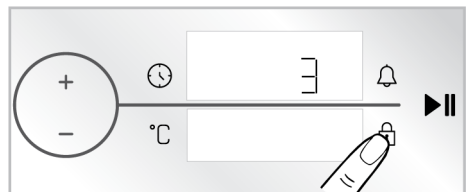
1. Touch the  key until the  symbol appears on the timer/duration display.





- ⇒ A countdown of 3-2-1 appears on the display. When the countdown is over, the  symbol appears on the timer/duration display and the key lock is activated. After the key lock is set, if any key is touched or the oven control knob is pushed, the timer sounds an audible signal and the  symbol flashes.



**i** While the key lock is activated, the keys of the control unit cannot be used. The key lock will not be cancelled in case of power failure.



### Deactivating the key lock

1. Touch the  key until the  symbol appears on the timer/duration display.
  - ⇒ A countdown of 3-2-1 appears on the display. When the countdown is over, the  symbol disappears on the timer/duration display and the key lock is deactivated.



### Setting the alarm

You can also use the control unit of the product for any warning or reminder other than baking. The alarm clock has no effect on the oven operating functions. It is used for warning purposes. For example, you can use the alarm clock when you want to turn the food in the oven at a certain time. As soon as the time you set has expired, the timer gives you an audible warning.

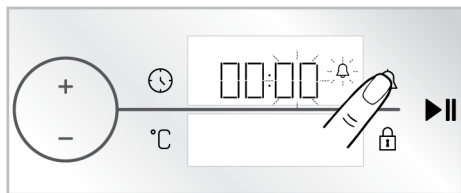

**i** The maximum alarm time may be 23 hours 59 minutes.

1. Touch the  key once to set the alarm period.
  - ⇒ The minute field and  symbol start to flash on the timer/duration display.

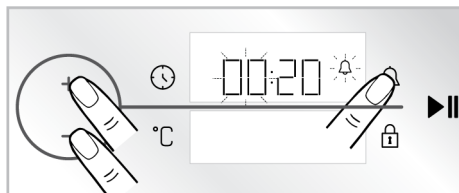

2. First, set the minutes by touching the **+**/**-** keys and activate the timer field by touching the  key once.
3. Set the time by touching **+**/**-** keys. Touch the  key again to confirm the setting.





- ⇒ On the timer/duration display, the  symbol lights up continuously and the alarm time starts to count down on the display.
4. After the alarm time is completed, the  symbol starts flashing and gives you an audible warning.

**i** If the alarm time and baking time are set at the same time, the shorter time is shown on the timer/duration display.

### Turning off the alarm

1. At the end of the alarm period, the warning sounds for one minute. Touch any key to stop the audible warning.
  - ⇒ The audible warning is stopped.

### If you want to cancel the alarm;

1. Touch the  key once to reset the alarm period.
  - ⇒ The  symbol starts to flash on the timer/duration display.
2. Turn the oven control knob to the right/left until the alarm time reaches "00:00".

### Setting the volume

You may set the volume of your control unit. Your oven should be turned off to perform this setting.

1. With the oven turned off (while the time of day appears on the display), touch the  key for about 3 seconds to activate the settings menu.

⇒ A countdown of 3-2-1 appears on the display. When the countdown is over, the settings menu is activated.

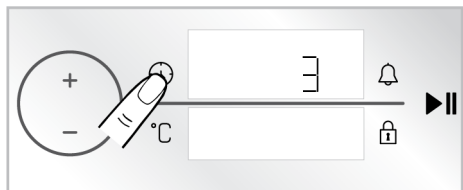

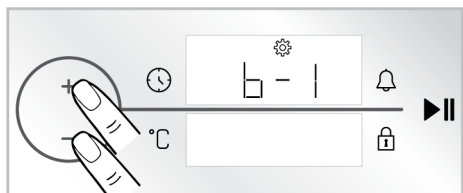

2. Touch the **+**/**-** keys until the “b-1” or “b-2” appears on the timer/duration display.

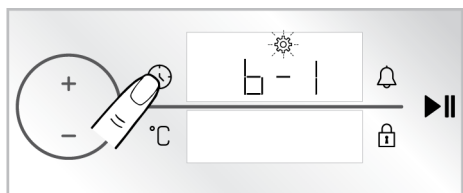

3. Activate the volume setting by touching the  key again.

⇒ The  symbol flashes on the timer/duration display.



4. Set the desired tone by touching the **+**/**-** keys.
5. Confirm the set tone by touching the  key again or pushing the oven control knob once.

### Setting the display brightness

You may set the brightness of the control unit display. Your oven should be turned off to perform this setting.

1. With the oven turned off (while the time of day appears on the display), touch the  key for about 3 seconds to activate the settings menu.

⇒ A countdown of 3-2-1 appears on the display. When the countdown is over, the settings menu is activated.

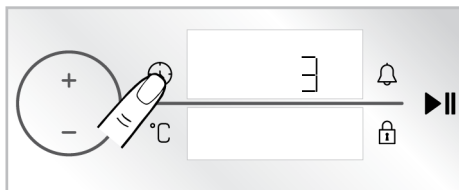

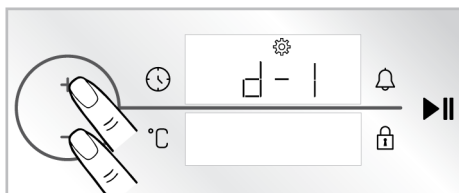

2. Touch the **+**/**-** keys until the “d-1”, “d-2” or “d-3” appears on the timer/duration display.

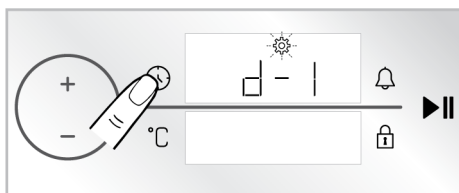

3. Activate the brightness setting by touching the  key again.

⇒ The  symbol flashes on the timer/duration display.



4. Set the desired period by touching the **+**/**-** keys.
5. Confirm the brightness by touching the  key again or pushing the oven control knob once.

### Setting the quick preheating (Booster) function

You may operate the baking on your product automatically with quick preheating function. For this purpose, you should

activate the quick preheat setting. Your oven should be turned off to perform this setting.

1. With the oven turned off (while the time of day appears on the display), touch the ⌚ key for about 3 seconds to activate the settings menu.

⇒ A countdown of 3-2-1 appears on the display. When the countdown is over, the settings menu is activated.

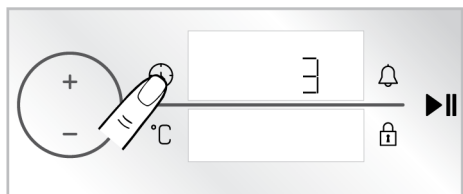

2. Touch **+**/**-** buttons until ⚙️ symbol and "OFF" appear on the display.

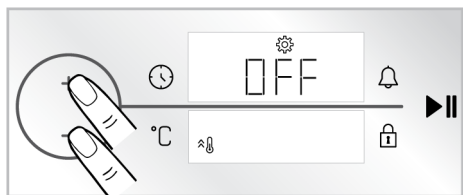

3. Activate the quick preheat (booster) setting by touching the ⌚ key.

⇒ The ⚙️ symbol flashes on the timer/duration display.

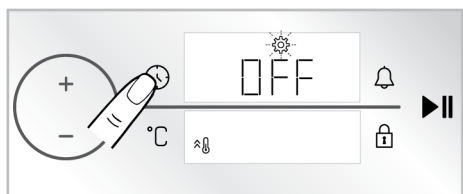

4. **+** By touching key "OFF" setting to "ON" on the display.

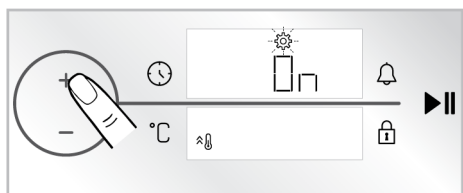

5. Confirm the quick preheat (booster) setting by touching the ⌚ key again.

**i** You may turn off the quick preheat setting with the same procedure. By turning the setting "OFF" you may cancel the quick preheat setting.

### Changing the time of day

To change the time of day that you have previously set,

1. With the oven turned off (while the time of day appears on the display), touch the ⌚ key for about 3 seconds to activate the settings menu.

⇒ A countdown of 3-2-1 appears on the display. When the countdown is over, the settings menu is activated.

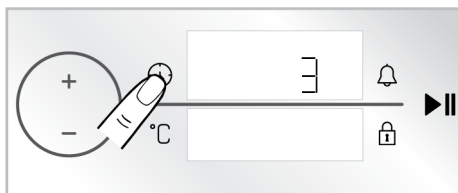

2. Touch the ⌚ key once to activate the timer field.

⇒ The timer field and the ⚙️ symbol flash on the timer/duration display.

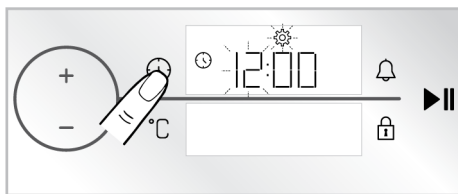

3. Set the time of day by touching the **+**/**-** keys and activate the minutes field by touching the ⌚ key once.

⇒ The minutes field and the ⚙️ symbol flash on the timer/duration display.

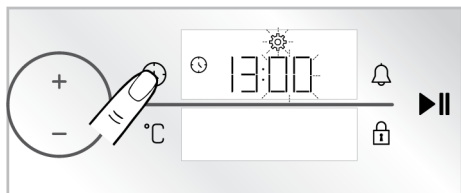



4. Touch the **+**/**-** keys to set the minute. Confirm the setting by touching the  key once.



⇒ The time of day is set and the  symbol illuminates continuously.

### Connecting the oven to the wireless network and introducing it to the "HomeWhiz" application

You may connect your oven to the wireless network and control it through the "HomeWhiz" application with a smart device. For this purpose, install the "HomeWhiz" application to your smart device first. The "HomeWhiz" application is available on IOS and Android mobile operating systems.

 After downloading the "HomeWhiz" application, follow the instructions on the application to create your home.

 You may complete the procedure to connect your oven to a wireless network and to activate the remote control of the oven by following the instructions provided on the application.

1. To switch the oven to setup mode, touch the  and  keys simultaneously for about 3 seconds when the oven is in off mode (time of day is shown on the display).

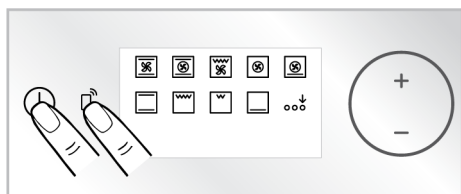

⇒ When the oven switches to the setup mode, an animation is displayed on the display where some lines flash.

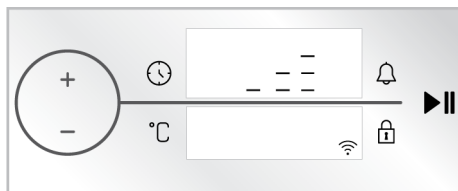



2. Open the "HomeWhiz" application you have installed on your smart device. After creating your home, select the oven under kitchen appliances and enter the stock number of your product to the application and follow the steps described on the application.



 The stock number of your product is the number starting with "77..." located at the bottom of the front cover of the manual.





3. Complete the introduction of your oven to the application by following the instructions provided on the application.

### Activating the remote control of the oven





After introducing your oven to the "HomeWhiz" application, to allow remote control:

1. Touch the  key once while the  symbol is shown on the display.

⇒ On the display, the  symbol shall be displayed with the  symbol together.



 If the  symbol is not displayed, touch the  key until the  symbol is shown on the display. If you have not introduced your appliance to the "HomeWhiz" application, the  symbol flashes once and an error signal is heard.



If the  symbol is shown on the display, but an error signal is heard when the  key is pressed and if the  symbol is not displayed on the display or the  symbol is blinking, check the internet connection of your product. If the internet connection is OK and the problem persists, repeat the steps for installation.

### Deleting the pairing of an oven connected to HomeWhiz

After adding your product to the "HomeWhiz" application, the user account you used for "HomeWhiz" pairs the information of your product. In order to delete a pair due to loss of access to the account you use in the application or for other reasons, the following actions must be taken.

1. With the product turned off (while the time of day appears on the display), touch the  and  keys for approximately 5 seconds.  
⇒ A countdown from 5 appears on the display.
2. After the countdown is complete, a deleting pair animation will appear on the display.
3. After the deleting pair process is completed without any problem, a warning sound will be heard and your oven will restart.



If a problem is encountered in the process of deleting a pair and the process cannot be completed, an error sound will be heard.

4. You can re-pair the product to your "HomeWhiz" account after deleting pair process is completed.

#### Compliance with the standards and testing information / EU declaration of conformity

	The development, manufacturing and sales stages of this product is conducted as per the safety rules specified in all relevant legislation of European Union.
<b>Frequency band</b>	: 2.4 Ghz
<b>Max. Transmission power</b>	: max. 100 mW
<b>CE declaration of conformity</b>	
Arçelik A.Ş. declares that this product complies with the 2014/53/EU Directive. A detailed RED Declaration of Conformity is available online in the <a href="http://support.beko.com">support.beko.com</a> website within the additional documents in the product page for your product.	

The defined cybersecurity-related software update support period of the product is the warranty period of the product. After this period, cybersecurity-related software updates are not guaranteed.

This product collects and transmits usage data when connected to the internet (e.g. temperature settings, usage duration, error

codes). In accordance with the EU Data Act (Regulation EU 2023/2854), you have the right to access and manage this data. For details on what data is collected, how it is used, and how to access it, please visit:

[www.homewhiz.com/eu-data-act-policy](http://www.homewhiz.com/eu-data-act-policy)

## 6 General Information About Cooking

You can find tips on preparing and cooking your food in this section.

Plus, this section describes some of the foods tested as producers and the most appropriate settings for these foods. Appropriate oven settings and accessories for these foods are also indicated.

## **6.1 General Warnings About Baking in the Oven**

- While opening the oven door during or after baking, hot-burning steam may emerge. The steam may burn your hand, face and/or eyes. When opening the oven door, stay away.
- Intense steam generated during baking may form condensed water drops on the interior and exterior of the oven and on the upper parts of the furniture due to the temperature difference. This is a normal and physical occurrence.
- The cooking temperature and time values given for foods may vary depending on the recipe and amount. For this reason, these values are given as ranges.
- Always remove unused accessories from the oven before you start cooking. Accessories that will remain in the oven may prevent your food from being cooked at the correct values.
- For foods that you will cook according to your own recipe, you can reference similar foods given in the cooking tables.
- Using the supplied accessories ensures you get the best cooking performance. Always observe the warnings and information provided by the manufacturer for the external cookware you will use.
- Cut the greaseproof paper you will use in your cooking in suitable sizes to the container you will cook. Greaseproof papers that are overflowing from the container can create a risk of burns and affect the quality of your baking. Use the greaseproof paper you will use in the temperature range specified.
- For good baking performance, place your food on the recommended correct shelf. Do not change the shelf position during baking.

## **6.1.1 Pastries and oven food**

### **General Information**

- We recommend using the accessories of the product for a good cooking performance. If you will use an external cookware, prefer dark, non-sticking and heat resistant ware.
- If preheating is recommended in the cooking table, be sure to put your food in the oven after preheating.
- If you will cook by using cookware on the wire grill, place it in the middle of the wire grill, not near the back wall.
- All materials used in making pastry should be fresh and at room temperature.
- The cooking status of the foods may vary depending on the amount of food and the size of the cookware.
- Metal, ceramic and glass moulds extend the cooking time and the bottom surfaces of pastry foods do not brown evenly.
- If you are using baking paper, a small browning can be observed on the bottom surface of the food. In this situation, you may have to extend your cooking period by approximately 10 minutes.
- The values specified in the cooking tables are determined as a result of the tests carried out in our laboratories. Values suitable for you may differ from these values.
- Place your food on the appropriate shelf recommended in the cooking table. Refer to the bottom shelf of the oven as shelf 1.

### **Tips for baking cakes**

- If the cake is too dry, increase the temperature by 10°C and shorten the baking time.
- If the cake is moist, use a small amount of liquid or reduce the temperature by 10°C.
- If the top of the cake is burnt, put it on the lower shelf, lower the temperature and increase the baking time.

- If the inside of the cake is cooked well, but outside is sticky, use less liquid, decrease the temperature and increase the cooking time.

### Hints for pastry

- If the pastry is too dry, increase the temperature by 10 °C and shorten the cooking time. Wet the dough sheets with a sauce consisting of milk, oil, egg and yoghurt mixture.
- If the pastry is getting cooked slowly, make sure that the thickness of the pastry you have prepared does not overflow the tray.

- If the pastry is browned on the surface but the bottom is not cooked, make sure that the amount of sauce you will use for the pastry is not too much at the bottom of the pastry. For an even browning, try to spread the sauce evenly between the dough sheets and the pastry.
- Bake your pastry in the position and temperature appropriate to the cooking table. If the bottom is still not browned enough, place it on a bottom shelf for the next cooking.

## Cooking table for pastries and oven foods

### Suggestions for baking with a single tray

Food	Accessory to be used	Operating function	Shelf position	Temperature (°C)	Baking time (min) (approx.)
Cake on the tray	Standard tray *	Top and bottom heating	3	180	30 ... 45
Cake in the mould	Cake mould on wire grill **	Fan Heating	2	180	30 ... 40
Small cakes	Standard tray *	Top and bottom heating	3	160	25 ... 35
Small cakes	Standard tray *	Fan Heating	3	150	25 ... 35
Sponge cake	Round springform pan, 26 cm in diameter on wire grill **	Top and bottom heating	2	150	30 ... 40
Sponge cake	Round springform pan, 26 cm in diameter on wire grill **	Fan Heating	2	150	35 ... 45
Cookie	Pastry tray *	Top and bottom heating	3	170	25 ... 40
Cookie	Pastry tray *	Fan Heating	3	170	20 ... 30
Rich pastry	Standard tray *	Top and bottom heating	2	200	30 ... 40
Rich pastry	Standard tray *	Fan assisted bottom/top heating	2	180	35 ... 45
Dough pastry	Standard tray *	Top and bottom heating	2	200	20 ... 35
Dough pastry	Standard tray *	Fan Heating	3	180	20 ... 30
Whole bread	Standard tray *	Top and bottom heating	3	200	30 ... 45
Whole bread	Standard tray *	Fan Heating	3	200	30 ... 40
Lasagne	Glass / metal rectangular container on wire grill **	Top and bottom heating	2 or 3	200	30 ... 45

Food	Accessory to be used	Operating function	Shelf position	Temperature (°C)	Baking time (min) (approx.)
Apple pie	Round black metal mould, 20 cm in diameter on wire grill **	Top and bottom heating	2	180	50 ... 70
Apple pie	Round black metal mould, 20 cm in diameter on wire grill **	Fan Heating	3	170	50 ... 65
Pizza	Standard tray *	Top and bottom heating	2	250	10 ... 20
Pizza	Standard tray *	Pizza function	2	280	5 ... 10

Preheating is recommended for all food.

\*These accessories may not be included with your product.

\*\*These accessories are not included with your product. They are commercially available accessories.

### Suggestions for cooking with two trays

Food	Accessory to be used	Operating function	Shelf position	Temperature (°C)	Baking time (min) (approx.)
Small cakes	2-Standard tray * 4-Pastry tray *	Fan Heating	2 - 4	150	25 ... 35
Cookie	2-Standard tray * 4-Pastry tray *	Fan Heating	2 - 4	170	25 ... 35
Rich pastry	1-Standard tray * 4-Pastry tray *	Fan Heating	1 - 4	180	40 ... 50
Dough pastry	2-Standard tray * 4-Pastry tray *	Fan Heating	2 - 4	180	20 ... 30

Preheating is recommended for all food.

\*These accessories may not be included with your product.

\*\*These accessories are not included with your product. They are commercially available accessories.

### Cooking table with operating function "Eco fan heating"

- Do not change the temperature setting after starting cooking in the operating function "Eco fan heating".

- Do not open the oven door when cooking in the "Eco fan heating" operating function. If the door does not open, the internal temperature is optimized to save energy, and this temperature may differ from what is shown on the display.
- Do not preheat in the "Eco fan heating" operating function.

Food	Accessory to be used	Shelf position	Temperature (°C)	Baking time (min) (approx.)
Small cakes	Standard tray *	3	160	25 ... 35
Cookie	Standard tray *	3	180	25 ... 35
Rich pastry	Standard tray *	3	200	45 ... 55
Dough pastry	Standard tray *	3	200	35 ... 45

\*These accessories may not be included with your product.

\*\*These accessories are not included with your product. They are commercially available accessories.

## 6.1.2 Meat, Fish and Poultry

### The key points on grilling

- Seasoning it with lemon juice and pepper before cooking whole chicken, turkey and large pieces of meat will increase cooking performance.
- It takes 15 to 30 minutes more to cook boned meat than fillet by frying.
- You should calculate about 4 to 5 minutes of cooking time per centimetre of the meat thickness.

- After the cooking time is expired, keep the meat in the oven for approximately 10 minutes. The juice of the meat is better distributed to the fried meat and does not come out when the meat is cut.
- Fish should be placed on the medium or low level shelf in a heat resistant plate.
- Cook the recommended dishes in the cooking table with a single tray.

### Cooking table for meat, fish and poultry

Food	Accessory to be used	Operating function	Shelf position	Temperature (°C)	Baking time (min) (approx.)
Steak (whole) / Roast (1 kg)	Standard tray *	Fan assisted bottom/top heating	3	15 mins. 250/ max, after 180 ... 190	60 ... 80
Lamb's shank (1,5-2 kg)	Standard tray *	Fan assisted bottom/top heating	3	170	85 ... 110
Fried chicken (1,8-2 kg)	Wire grill * Place one tray on a lower shelf	Fan assisted bottom/top heating	2	15 mins. 250/ max, after 190	60 ... 80
Fried chicken (1,8-2 kg)	Wire grill * Place one tray on a lower shelf	Fan Heating	2	200 ... 220	60 ... 80
Fried chicken (1,8-2 kg)	Wire grill * Place one tray on a lower shelf	"3D" function	2	15 mins. 250/ max, after 190	60 ... 80
Turkey (5.5 kg)	Standard tray *	Fan assisted bottom/top heating	1	25 mins. 250/ max, after 180 ... 190	150 ... 210
Turkey (5.5 kg)	Standard tray *	"3D" function	1	25 mins. 250/ max, after 180 ... 190	150 ... 210
Fish	Wire grill * Place one tray on a lower shelf	Fan assisted bottom/top heating	3	200	20 ... 30
Fish	Wire grill * Place one tray on a lower shelf	"3D" function	3	200	20 ... 30

Preheating is recommended for all food.

\*These accessories may not be included with your product.

\*\*These accessories are not included with your product. They are commercially available accessories.

### 6.1.3 Grill

Red meat, fish and poultry meat quickly turns brown when grilled, holds a beautiful crust and does not dry out. Fillet meats, skewer meats, sausages as well as juicy vegetables (tomatoes, onions, etc.) are particularly suitable for grilling.

#### General warnings

- Food not suitable for grilling carries a fire hazard. Grill only food that is suitable for heavy grill fire. Also, do not place the food too far in the back of the grill. This is the hottest area and fatty foods may catch fire.
- When the preheating time is 5 minutes in the grill mode, skip the preheating, do not wait for the entire preheating time to pass.
- **Close the oven door during grilling. Never grill with the oven door open. Hot surfaces may cause burns!**

#### Grill table

Food	Accessory to be used	Shelf position	Temperature (°C)	Baking time (min) (approx.)
Fish	Wire grill	4 - 5	250	20 ... 25
Chicken pieces	Wire grill	4 - 5	250	25 ... 35
Meatball (veal) - 12 amount	Wire grill	4	250	20 ... 30
Lamb chop	Wire grill	4 - 5	250	20 ... 25
Steak - (meat cubes)	Wire grill	4 - 5	250	25 ... 30
Veal chop	Wire grill	4 - 5	250	25 ... 30
Vegetable gratin	Wire grill	4 - 5	220	20 ... 30
Toast bread	Wire grill	4	250	1 ... 4

Skip preheating after 5 minutes in grill.

Turn pieces of food after 1/2 of the total grilling time.

### 6.1.4 Shallow or Oil-Free Frying Function

In the "Airfry" function, you can make shallow frying or oil-free frying with hot air in the oven.

#### General warnings

- Please refer to the recommended baking table for "Airfry" function.
- Use the frying tray (Airfry) provided with the product for this function.

#### The key points of the grill

- Prepare foods of similar thickness and weight as much as possible for the grill.
- Place the pieces to be grilled on the wire grill or wire grill tray by distributing them without exceeding the dimensions of the heater.
- Depending on the thickness of the pieces to be grilled, the cooking times given in the table may vary.
- Slide the wire grill or the wire grill tray to the desired level in the oven. If you are cooking on the wire grill, slide the oven tray to the lower shelf to collect the oils. The oven tray you will slide should be sized to cover the entire grill area. This tray may not be supplied with the product. Put some water into the oven tray for easy cleaning.

- For a good frying result, place the foods on the frying tray in a way they will not overlap.
- **Place an oven tray on the bottom shelf to collect the oil while frying. Place a heat-resistant baking paper or a similar material recommended for oven use inside the inserted tray.**
- **If a tray is not used on the bottom shelf, any dripping oil or other substances from the food can cause heavy smoke and even flames.**

- You can use the ""3D" function" function to speed up the preheating time. Switch to "Airfry" function when preheating is complete.

### Frying table - "Airfry"

Food	Operating function	Shelf position	Temperature (°C)	Baking time (min) (approx.)	Recommended amount
Homemade potato *	Airfry	3	220	20 ... 40	200-1000
Frozen potato **	Airfry	3	220	15 ... 35	200-1400
Chicken leg /wing	Airfry	3	220	20 ... 40	500-1500
Chicken breast	Airfry	3	220	30 ... 40	200-700
Whole chicken	Airfry	3	15 mins. 250/max after 190	60 ... 80	1800-2000
Frozen nugget **	Airfry	3	220	15 ... 25	400-1000
Meatball	Airfry	3	220	20 ... 30	20-25 amount
Whole fish	Airfry	3	220	15 ... 25	2-5 amount
Frozen crunchy fish ** (fish fingers)	Airfry	3	220	15 ... 25	500-1500
Frozen pastry **	Airfry	3	220	25 ... 35	200-800 (10-40 amount)
Frozen pizza **	Airfry	3	220	10 ... 20	2-4 amount
Sausage	Airfry	3	220	15 ... 25	10-20 amount
Mixed Vegetables	Airfry	3	220	20 ... 25	400-1000
Muffin	Airfry	3	220	25 ... 35	20-25 amount
Stuffed pepper	Airfry	3	220	25 ... 35	20-25 amount

\* Hold the potatoes in water for 30 minutes, dry and add ¼ to 1 tablespoon of oil.

\*\* Preheat.

#### 6.1.4.1 Drying Function

Use the drying function to preserve and/or dry goods including fruits, vegetables, and herbs. By using a fan heater and fan on the oven's rear wall to circulate optimally heated air throughout the oven, this feature gently removes moisture.

- Use the drying function to dry goods including fruits, vegetables, and herbs. Drying is advised to take place between 50 and 70 °C.

- The amount of moisture, sugar content, size and thickness of the food, and ambient humidity all affect how quickly food dries.
- Cut the fruit and vegetables 1-2 cm thick.
- To maintain the color during drying, the oven door must be left open. Placing a wooden spoon in the upper corner between the door and the oven will help keep the door open. Make sure that the object does not touch the oven seal.

Food	Accessory to be used	Operating function	Shelf position	Temperature (°C)	Baking time (min) (approx.)
Apple	Frying tray (Airfry)	Airfry	3	50	300 ... 540
Orange slices, peels	Frying tray (Airfry)	Airfry	3	50	300 ... 540
Limon	Frying tray (Airfry)	Airfry	3	50	300 ... 540
Quince	Frying tray (Airfry)	Airfry	3	50	300 ... 540
Herb	Frying tray (Airfry)	Airfry	3	50	240 ... 420

## 6.1.5 Test foods

- Foods in this cooking table are prepared according to the EN 60350-1 standard to facilitate testing of the product for control institutes.

### Cooking table for test meals

#### Suggestions for baking with a single tray

Food	Accessory to be used	Operating function	Shelf position	Temperature (°C)	Baking time (min) (approx.)
Shortbread (sweet cookie)	Standard tray *	Top and bottom heating	3	140	20 ... 30
Shortbread (sweet cookie)	Standard tray *	Fan Heating	On models with wire shelves :3 On models without wire shelves :2	140	15 .. 25
Small cakes	Standard tray *	Top and bottom heating	3	160	25 ... 35
Small cakes	Standard tray *	Fan Heating	3	150	25 ... 35
Sponge cake	Round springform pan, 26 cm in diameter on wire grill **	Top and bottom heating	2	150	30 ... 40
Sponge cake	Round springform pan, 26 cm in diameter on wire grill **	Fan Heating	2	150	35 ... 45
Apple pie	Round black metal mould, 20 cm in diameter on wire grill **	Top and bottom heating	2	180	50 ... 70
Apple pie	Round black metal mould, 20 cm in diameter on wire grill **	Fan Heating	3	170	50 ... 65

Preheating is recommended for all food.

\*These accessories may not be included with your product.

\*\*These accessories are not included with your product. They are commercially available accessories.

#### Suggestions for cooking with two trays

Food	Accessory to be used	Operating function	Shelf position	Temperature (°C)	Baking time (min) (approx.)
Small cakes	2-Standard tray * 4-Pastry tray *	Fan Heating	2 - 4	150	25 ... 35
Shortbread (sweet cookie)	2-Standard tray * 4-Pastry tray *	Fan Heating	2 - 4	140	15 ... 25

Preheating is recommended for all food.

\*These accessories may not be included with your product.

\*\*These accessories are not included with your product. They are commercially available accessories.

## Grill

Food	Accessory to be used	Shelf position	Temperature (°C)	Baking time (min) (approx.)
Meatball (veal) - 12 amount	Wire grill	4	250	20 ... 30
Toast bread	Wire grill	4	250	1 ... 3

It is recommended to preheat for 5 minutes for all grilled food.

Turn pieces of food after 1/2 of the total grilling time.

### Yogurt

#### Preparation of yogurt;

1. Remove the accessories and side wire shelves (if any) from the cooking area.
2. Place the yogurt cookware on the bottom of the cooking area.
3. After preparing the yogurt, let it rest in the refrigerator for at least 12 hours.
4. Keep the oven door half open during the entire time.

Food	Operating function	Shelf position	Temperature (°C)	Baking time (min) (approx.)
Yogurt	Fan Heating	Bottom of the cooking area	50 - 60	240 ... 360

## 7 Maintenance and Cleaning

### 7.1 General Cleaning Information

#### General warnings

- Wait for the product to cool before cleaning the product. Hot surfaces may cause burns!
- Do not apply the detergents directly on the hot surfaces. This may cause permanent stains.
- The product should be thoroughly cleaned and dried after each operation. Thus, food residues shall be easily cleaned and these residues shall be prevented from burning when the product is used again later. Thus, the service life of the appliance extends and frequently faced problems are decreased.
- Do not use steam cleaning products for cleaning.
- Some detergents or cleaning agents cause damage to the surface. Unsuitable cleaning agents are: bleach, cleaning products containing ammonia, acid or chloride, steam cleaning products, descaling agents, stain and rust removers, abrasive cleaning products (cream cleaners, scouring powder, scouring cream,

abrasive and scratching scrubber, wire, sponges, cleaning cloths containing dirt and detergent residues).

- No special cleaning material is needed in the cleaning made after each use. Clean the appliance using dishwashing detergent, warm water and a soft cloth or sponge and dry it with a dry cloth.
- Be sure to completely wipe off any remaining liquid after cleaning and immediately clean any food splashing around during cooking.
- Do not wash any component of your appliance in a dishwasher unless otherwise stated in the user's manual.
- You should store the appliance according to handling marks indication on the carton box.

#### Inox - stainless surfaces

- Do not use acid or chlorine-containing cleaning agents to clean stainless-inox surfaces and handles.
- Stainless-inox surface may change colour in time. This is normal. After each operation, clean with a detergent suitable for the stainless or inox surface.

- Clean with a soft soapy cloth and liquid (non-scratching) detergent suitable for inox surfaces, taking care to wipe in one direction.
- Remove lime, oil, starch, milk and protein stains on the glass and inox surfaces immediately without waiting. Stains may rust under long periods of time.
- Cleaners sprayed/applied to the surface should be cleaned immediately. Abrasive cleaners left on the surface cause the surface to turn white.

### **Enamelled surfaces**

- The oven must cool down before cleaning the cooking area. Cleaning on hot surfaces shall create both fire hazard and damage the enamel surface.
- After each use, clean the enamel surfaces using dishwashing detergent, warm water and a soft cloth or sponge and dry them with a dry cloth.
- If your product has an easy steam cleaning function, you can make easy steam cleaning for light non-permanent dirt. (See “Easy Steam Cleaning”.)
- For difficult stains, an oven and grill cleaner recommended on the website of your product brand can be used. Do not use an external oven cleaner. If the surface is heavily soiled, slightly moisten it and gently clean with a soft-bristled brush or scrubbing wire. Avoid applying excessive pressure.

### **Catalytic surfaces**

- The side walls in the cooking area can only be covered with enamel or catalytic walls. It varies by model.
- The catalytic walls have a light matte and porous surface. The catalytic walls of the oven should not be cleaned.
- Catalytic surfaces absorb oil thanks to its porous structure and start to shine when the surface is saturated with oil, in this case it is recommended to replace the parts.

### **Glass surfaces**

- When cleaning glass surfaces, do not use hard metal scrapers and abrasive cleaning materials. They can damage the glass surface.
- Clean the appliance using dishwashing detergent, warm water and a microfiber cloth specific for glass surfaces and dry it with a dry microfiber cloth.
- If there is residual detergent after cleaning, wipe it with cold water and dry with a clean and dry microfiber cloth. Residual detergent may damage the glass surface next time.
- Under no circumstances should the dried-up residue on the glass surface be cleaned off with serrated knives, wire wool or similar scratching tools.
- You can remove the calcium stains (yellow stains) on the glass surface with the commercially available descaling agent, with a descaling agent such as vinegar or lemon juice.
- If the surface is heavily soiled, apply the cleaning agent on the stain with a sponge and wait a long time for it to work properly. Then clean the glass surface with a wet cloth.
- Discolorations and stains on the glass surface are normal and not defects.

### **Plastic parts and painted surfaces**

- Clean plastic parts and painted surfaces using dishwashing detergent, warm water and a soft cloth or sponge and dry them with a dry cloth.
- Do not use hard metal scrapers and abrasive cleaners. They may damage the surfaces.
- Ensure that the joints of the components of the product are not left damp and with detergent. Otherwise, corrosion may occur on these joints.

## **7.2 Cleaning Accessories**

Do not put the product accessories in a dishwasher unless otherwise stated in the user’s manual.

### Cleaning the barrier coated accessories

Before using the barrier coated tray for the first time; place the tray in the oven and operate the oven at 200°C for 40 minutes just once.

Harsh abrasive cleaning materials should not be used for cleaning the barrier coated accessories. Preferably clean by means of a soft cloth or sponge with a cream surface cleaner.

Soak your barrier-coated accessories in warm water for 10 minutes after demanding cooking conditions (functions such as grill, grill+fan). Then clean with a soft cloth or sponge.

### 7.3 Cleaning the Control Panel

- When cleaning the panels with knob-control, wipe the panel and knobs with a damp soft cloth and dry with a dry cloth. Do not remove the knobs and gaskets underneath to clean the panel. The control panel and knobs may be damaged.
- While cleaning the inox panels with knob control, do not use inox cleaning agents around the knob. The indicators around the knob can be erased.
- Clean the touch control panels with a damp soft cloth and dry with a dry cloth. If your product has a key lock feature, set the key lock before performing control panel cleaning. Otherwise, incorrect detection may occur on the keys.

### 7.4 Cleaning the inside of the oven (cooking area)

Follow the cleaning steps described in the "General Cleaning Information" section according to the surface types in your oven.

#### Cleaning the side walls of the oven

The side walls in the cooking area can only be covered with enamel or catalytic walls. It varies by model. If there is a catalytic wall, refer to the "Catalytic surfaces" section for information.

If your product is a wire shelf model, remove the wire shelves before cleaning the side walls. Then complete the cleaning as

described in the "General Cleaning Information" section according to the side wall surface type.

#### To remove the side wire shelves:

1. Remove the front of the wire shelf by pulling it on the side wall in the opposite direction.
2. Pull the wire shelf towards you to remove it completely.

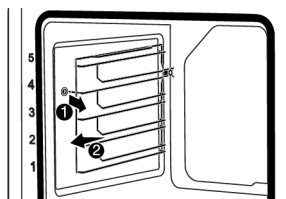

3. To reattach the shelves, the procedures applied when removing them must be repeated from the end to the beginning, respectively.

### 7.5 Easy Steam Cleaning

This allows cleaning of the dirt (not remaining for a long time) that is softened by the steam inside the oven and by the water droplets condensed in the internal surfaces of the oven easily.

1. Remove all accessories inside the oven.
2. Add 500 ml water into the tray and place it on the 2nd shelf of the oven.



Do not use distilled or filtered water. Use ready-made waters only. Do not use flammable, alcoholic or solid particulate solutions instead of water.

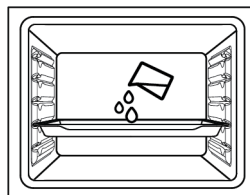

3. Set the oven to the "Bottom heating" operating mode and operate it at 100°C for 20 minutes.

Immediately open the door and wipe the oven interiors with a wet sponge or cloth. Steam will be released when opening the door. This may pose a risk of burns. Be careful when opening the door.

For stubborn dirt, clean the product using dishwashing detergent, warm water and a soft cloth or sponge and dry it with a dry cloth.

**i** In the easy steam cleaning function, it is expected that the added water evaporates and condenses on the inside of the oven and the oven door in order to soften the light dirt formed in your oven. Condensation formed on the oven door may drip around when the oven door is opened. As soon as you open the oven door, wipe off the condensation.

After the condensation inside the oven, puddle or moisture may occur in the pool channel under the oven. Wipe this pool channel with a damp cloth after use and dry it.

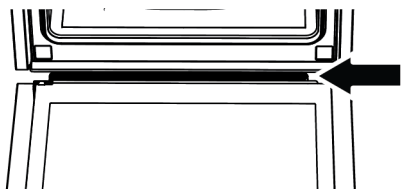

## 7.6 Cleaning the Oven Door

You can remove your oven door and door glasses to clean them. How to remove the doors and windows is explained in the sections "**Removing the oven door**" and "**Removing the inner glasses of the door**".

After removing the door inner glasses, clean them using a dishwashing detergent, warm water and a soft cloth or sponge and dry them with a dry cloth. For lime residue that may form on the oven glass, wipe the glass with vinegar and rinse.

**i** Do not use harsh abrasive cleaners, metal scrapers, wire wool or bleach materials to clean the oven door and glass.

### Removing the oven door

1. Open the oven door.
2. Open the clips in the front door hinge socket on the right and left by pushing them downwards as shown in the figure.
3. Hinge types vary as (A), (B), (C) types according to the product model. The following figures show how to open each type of hinge.
4. (A) type hinge is available in normal door types.

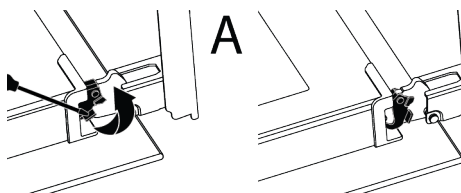

5. (B) type hinge is available in soft closing door types.

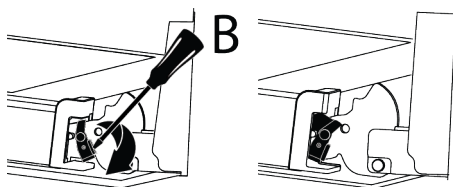

6. (C) type hinge is available in soft opening/closing door types.

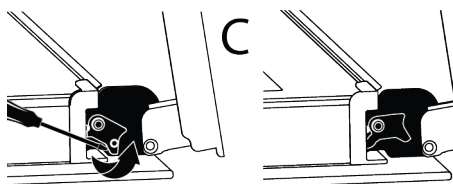

7. Get the oven door to a half-open position.

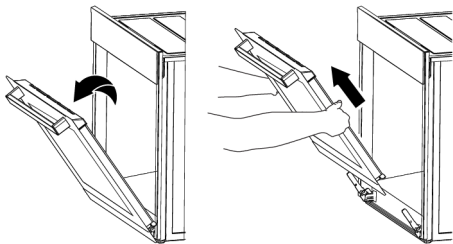

8. Pull the removed door upwards to release it from the right and left hinges and remove it.

**i** To reattach the door, the procedures applied when removing it must be repeated from the end to the beginning, respectively. When installing the door, be sure to close the clips on the hinge socket.

### 7.7 Removing the Inner Glass of The Oven Door

Inner glass of the product's front door may be removed for cleaning.

1. Open the oven door.
2. Pull the plastic component, attached on the upper section of the front door, towards yourself by simultaneously pushing on the pressure points on both sides of the component and remove it.

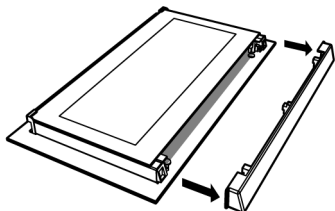
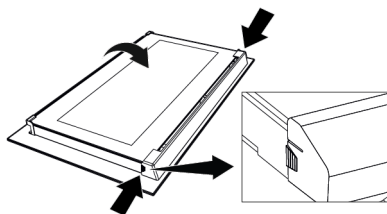

3. As shown in the figure, gently lift the innermost glass (1) towards "A" and then, remove it by pulling towards "B".

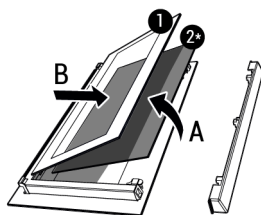

- 1 Innermost glass
- 2\* Inner glass (it may not be available for your product)

4. If your product has an inner glass (2), repeat the same process to detach it (2).
5. The first step of regrouping the door is to reassemble the inner glass (2). Place the bevelled edge of the glass to meet the bevelled edge of the plastic slot. (If your product has an inner glass). Inner glass (2) must be attached to the plastic slot closest to the innermost glass (1).
6. While reassembling the innermost glass (1), pay attention to place the printed side of the glass on the inner glass. It is crucial to place the lower corners of the innermost glass (1) to meet the lower plastic slots.
7. Push the plastic component towards the frame until a "click" sound is heard.

### 7.8 Cleaning the Oven Lamp

In the event that the glass door of the oven lamp in the cooking area becomes dirty; clean using dishwashing detergent, warm water and a soft cloth or sponge and dry with a dry cloth. In case of oven lamp failure, you can replace the oven lamp by following the sections that follow.

#### Replacing the oven lamp

##### General warnings

- To avoid the risk of electric shock before replacing the oven lamp, disconnect the product and wait for the oven to cool. Hot surfaces may cause burns!
- This oven is powered by an incandescent lamp with less than 40 W, less than 60 mm in height, less than 30 mm in diameter, or a halogen lamp with G9 sockets with less than 60 W power. Lamps are

suitable for operation at temperatures above 300 °C. Oven lamps are available from Authorised Services or licensed technicians. This product contains a G energy class lamp.

- The position of the lamp may differ from that is shown in the figure.
- The lamp used in this product is not suitable for use in the lighting of home rooms. The purpose of this lamp is to help the user see food products.
- The lamps used in this product must withstand extreme physical conditions such as temperatures above 50 °C.

**If your oven has a round lamp,**

1. Disconnect the product from the electricity.
2. Remove the glass cover by turning it counter clockwise.



3. If your oven lamp is type (A) shown in the figure below, rotate the oven lamp as shown in the figure and replace it with a new one. If it is type (B) model, pull it out as shown in the figure and replace it with a new one.

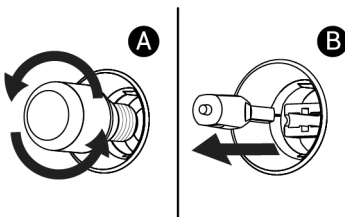

**8 Troubleshooting**

If the problem persists after following the instructions in this section, contact your vendor or an Authorized Service. Never try to repair your product yourself.

4. Refit the glass cover.

**If your oven has a square lamp,**

1. Disconnect the product from the electricity.
2. Remove the wire shelves according to the description.

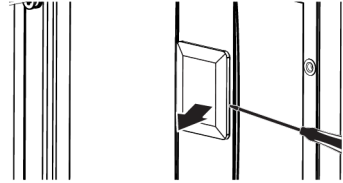

3. Lift the lamp's protective glass cover with a screwdriver. Remove the screw first, if there is a screw on the square lamp in your product.
4. If your oven lamp is type (A) shown in the figure below, rotate the oven lamp as shown in the figure and replace it with a new one. If it is type (B) model, pull it out as shown in the figure and replace it with a new one.

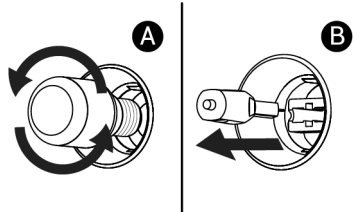

5. Refit the glass cover and wire shelves.

**Steam is emanated while the oven is working.**

- It is normal to see vapour during operation. >>> This is not an error.

### **Water droplets appear while cooking**

- The steam generated during cooking condenses when it comes into contact with cold surfaces outside the product and may form water droplets. >>> This is not an error.

### **Metal sounds are heard while the product is warming and cooling.**

- Metal parts may expand and make sounds when heated. >>> This is not an error.

### **The product does not work.**

- Fuse may be faulty or blown. >>> Check the fuses in the fuse box. Change them if necessary or reactivate them.
- The appliance may not be plugged to the (grounded) outlet. >>> Check if the appliance is plugged in to the outlet.
- (If there is timer on your appliance) Keys on the control panel do not work. >>> If your product has a key lock, the key lock may be enabled, disable the key lock.

### **Oven light is not on.**

- Oven lamp may be faulty. >>> Replace oven's lamp.
- No electricity. >>> Ensure the mains is operational and check the fuses in the fuse box. Change the fuses if necessary or reactivate them.

### **Oven is not heating.**

- The oven may not be set to a specific cooking function and/or temperature. >>> Set the oven to a specific cooking function and/or temperature.
- For the models with timer, the time is not set. >>> Set the time.
- No electricity. >>> Ensure the mains is operational and check the fuses in the fuse box. Change the fuses if necessary or reactivate them.
- The oven door may be open. >>> Make sure the oven door is closed. If the oven door remains open for more than 5 minutes, the time setting made for cooking is cancelled and heaters do not work.

### **(For models with timer) The timer display flashes or the timer symbol is left open.**

- There has been a power outage before. >>> Set the time / Turn off the product function knobs and again switch it to the desired position.

### **After cooking starts ► symbol flashes on the display and there is an audible warning.**

- The oven door may be open. >>> Make sure the oven door is completely closed. Contact the authorized service if the fault continues.

### **The command you would like to send from the "HomeWhiz" application does not go through. (if the remote access conditions are met)**

- Your link may be interrupted for a while. >>> Make sure the oven is connected to the wireless network and turn the application off and on.

### **"HomeWhiz" application does not show the oven status right.**

- Your link may be interrupted for a while. >>> Make sure the oven is connected to the wireless network and turn the application off and on.

### **After introducing your product to the "HomeWhiz" application, if there is an error saying "An error occurred while associating your product to your home or the room you specified. This device belongs to another home." or if you forgot in which "HomeWhiz" account**

- Delete the pairing by following the instructions in the section "Deleting the pairing of a "HomeWhiz" connected oven" and repeat the product pairing from the beginning.

### **"Multiple bluetooth networks detected" warning shows while installing the product to the "HomeWhiz" app.**

- In case more than one house appliance in your home is set to setup mode at the same time and broadcasting bluetooth signal, you may encounter "Multiple bluetooth networks detected" warning

whilst the installation to the "HomeWhiz" app. >>> Shut off the installation modes of the other appliances and continue using just one appliance with installation mode on.

**Terms other than the language I specified show up at the "HomeWhiz" app.**

- In cases where the internet power is low, terms in different languages may appear in the homewhiz application other than the languages you defined in the application. >>> This is not an error.

Additional Information for User Manual:	Technical information on the operating Low Power Modes pursuant to EU Regulation 2023/826	
Mode	POWER CONSUMPTION(WATT)	PERIOD(MINUTES)*
Off	-	-
Standby	-	-
Standby Mode with information or status display	0,8	20
Networked Standby	2,0	20

\*:The period after which the equipment reaches automatically standby mode, off mode or networked standby in minutes and rounded to the nearest minute.





