

Built-in Hob

User manual

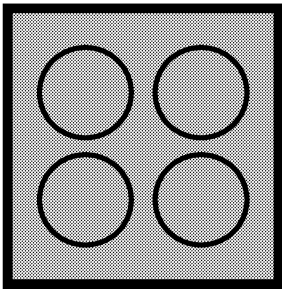

HDMC32400TX1

EN

185.9277.70/R.AA/25.12.2017

Please read this user manual first!

Dear Customer,

Thank you for purchasing this Beko product. We hope that you get the best results from your product which has been manufactured with high quality and state-of-the-art technology. Therefore, please read this entire user manual and all other accompanying documents carefully before using the product and keep it as a reference for future use. If you handover the product to someone else, give the user manual as well. Follow all warnings and information in the user manual.

Remember that this user manual is also applicable for several other models. Differences between models will be identified in the manual.

Explanation of symbols

Throughout this user manual the following symbols are used:

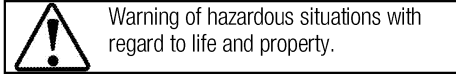

Arçelik A.Ş.
Karaağaç caddesi No:2-6
34445 Sütlüce/İstanbul/TURKEY
Made in TURKEY



This product was manufactured using the latest technology in environmentally friendly conditions.

TABLE OF CONTENTS

1 Important instructions and warnings for safety and environment 4

General safety	4
Electrical safety	4
Product safety	5
Intended use	6
Safety for children.....	6
Disposing of the old product.....	7
Package information	7
Future Transportation.....	7

2 General information 8

Overview	8
Technical specifications	8

3 Installation 9

Before installation	9
Installation and connection	9

4 Preparation 12

Tips for saving energy	12
Initial use	12
First cleaning of the appliance.....	12
Initial heating	12

5 How to use the hob 13

General information about cooking	13
Using the hobs.....	13
Control panel	14

6 Maintenance and care 18

General information.....	18
Cleaning the hob	18
Cleaning the control panel	18

7 Troubleshooting 19

1 Important instructions and warnings for safety and environment

This section contains safety instructions that will help protect from risk of personal injury or property damage. Failure to follow these instructions shall void any warranty.

General safety

- The appliance is not intended for use by persons (including children) with reduced physical, sensory or mental capabilities, or lack of experience and knowledge, unless they have been given supervised or instruction concerning use of the appliance by a responsible person for their safety.
- Young children should be supervised to ensure that they do not play with the appliance.
- If the product is handed over to someone else for personal use or second-hand use purposes, the user manual, product labels and other relevant documents and parts should be also given.
- Installation and repair procedures must always be performed by Authorised Service Agents. The manufacturer shall not be held responsible for damages arising from procedures carried out by unauthorised persons which may also void the warranty. Before

installation, read the instructions carefully.

- Do not operate the product if it is defective or has any visible damage.
- Ensure that the product function knobs are switched off after every use.

Electrical safety

- If the product has a failure, it should not be operated unless it is repaired by an Authorised Service Agent. There is the risk of electric shock!
- Only connect the product to a grounded outlet/line with the voltage and protection as specified in the “Technical specifications”. Have the grounding installation made by a qualified electrician while using the product with or without a transformer. The manufacturer shall not be liable for any problems arising due to the product not being earthed in accordance with the local regulations.
- Never wash the product by spreading or pouring water onto it! There is the risk of electric shock!
- The product must be disconnected during installation,

maintenance, cleaning and repairing procedures.

- If the supply cord is damaged, it must be replaced by the manufacturer or its service agent or a similarly qualified person in order to avoid a hazard.
- The appliance must be installed so that it can be completely disconnected from the mains supply. The separation must be provided by a switch built into the fixed electrical installation, according to construction regulations.
- If the electrical supply is restricted, means of all-pole disconnection must be accessible and incorporated in the fixed wiring in accordance with the wiring rules.
- Any work on electrical equipment and systems should only be carried out by authorised and qualified persons.
- In case of any damage, switch off the product and disconnect it from the mains. To do this, turn off the fuse at home.
- Make sure that fuse rating is compatible with the product.

Product safety

- **WARNING:** The appliance and its accessible parts become hot during use. Care should be taken to avoid touching heating

elements. Children less than 8 years of age shall be kept away unless continuously supervised.

- Never use the product when your judgment or coordination is impaired by the use of alcohol and/or drugs.
- Be careful when using alcoholic drinks in your dishes. Alcohol evaporates at high temperatures and may cause fire since it can ignite when it comes into contact with hot surfaces.
- Do not place any flammable materials close to the product as the sides may become hot during use.
- Keep all ventilation slots clear of obstructions.
- Do not use a steam cleaner to clean this appliance.
- **WARNING:** Unattended cooking on a hob with fat or oil can be dangerous and may result in fire. NEVER try to extinguish a fire with water, but switch off the appliance and then cover flame e.g. with a lid or a fire blanket.
- **CAUTION:** The cooking process has to be supervised. A short term cooking process has to be supervised continuously.
- **WARNING:** Danger of fire: Do not store items on the cooking surfaces.

- **WARNING:** If the surface is cracked, switch off the appliance to avoid the possibility of electric shock.
- In case of hotplate glass breakage : Immediately shut off all burners and any electrical heating element and isolate the appliance from the power supply. Do not touch the appliance surface. Do not use the appliance.
- Metallic objects such as knives, forks, spoons and lids should not be placed on the hotplate since they can get hot.
- The appliance is not intended to be operated by means of an external timer or separate remote-control system.
- Vapour pressure that build up due to the moisture on the hob surface or at the bottom of the pot can cause the pot to move. Therefore, make sure that the oven surface and bottom of the pots are always dry.
- **WARNING:** Use only hob guards designed by the manufacturer of the cooking appliance or indicated by the manufacturer of the appliance in the instructions for use as suitable or hob guards incorporated in the appliance. The use of inappropriate guards can cause accidents.

Prevention against possible fire risk!

- Ensure all electrical connections are secure and tight to prevent risk of arcing.
- Do not use damaged cables or extension cables.
- Ensure liquid or moisture is not accessible to the electrical connection point.

Intended use

- This product is designed for domestic use. Commercial use will void the guarantee.
- This appliance is for cooking purposes only. It must not be used for other purposes, for example room heating.
- The manufacturer shall not be liable for any damage caused by improper use or handling errors.

Safety for children

- **WARNING:** Accessible parts will become hot when in use. To avoid burns and scalds children should be kept away.
- The packaging materials will be dangerous for children. Keep the packaging materials away from children. Please dispose of all parts of the packaging according to environmental standards.
- Electrical products are dangerous to children. Keep children away from the product when it is operating and do not allow them to play with the product.

- Do not place any items above the appliance that children may reach for.

Disposing of the old product

Compliance with the WEEE Directive and Disposing of the Waste Product:



This product complies with EU WEEE Directive (2012/19/EU). This product bears a classification symbol for waste electrical and electronic equipment (WEEE).

This product has been manufactured with high quality parts and materials which can be reused and are suitable for recycling. Do not dispose of the waste product with normal domestic and other wastes at the end of its service life. Take it to the collection center for the recycling of electrical and electronic equipment. Please consult your local authorities to learn about these collection centers.

Compliance with RoHS Directive:

The product you have purchased complies with EU RoHS Directive (2011/65/EU). It does not contain harmful and prohibited materials specified in the Directive.

Package information

- Packaging materials of the product are manufactured from recyclable materials in accordance with our National Environment Regulations. Do not dispose of the packaging materials together with the domestic or other wastes. Take them to the packaging material collection points designated by the local authorities.

Future Transportation

- Keep the product's original carton and transport the product in it. Follow the instructions on the carton. If you do not have the original carton, pack the product in bubble wrap or thick cardboard and tape it securely.



Check the general appearance of your product for any damages that might have occurred during transportation.

2 General information

Overview

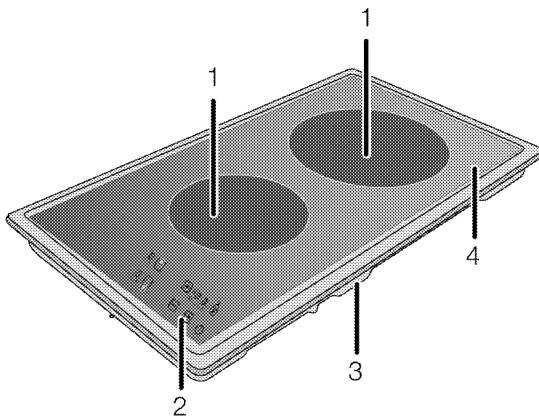

- 1 Single-circuit cooking plate
2 Control panel

- 3 Base cover
4 Burner plate

Technical specifications

Voltage / frequency	220-240 V ~ 50 Hz
Total power consumption	3 kW
Fuse	16 A
Cable type / section	min.H05V2V2-F 3 x 1,5 mm ²
External dimensions (height / width / depth)	55 mm/288 mm/510 mm
Installation dimensions (width / depth)	268 mm/490 mm
Burners	
Front	Single-circuit cooking plate
Dimension	140 mm
Power	1200 W
Rear	Single-circuit cooking plate
Dimension	180 mm
Power	1800 W



Technical specifications may be changed without prior notice to improve the quality of the product.



Figures in this manual are schematic and may not exactly match your product.



Values stated on the product labels or in the documentation accompanying it are obtained in laboratory conditions in accordance with relevant standards. Depending on operational and environmental conditions of the product, these values may vary.

3 Installation

Product must be installed by a qualified person in accordance with the regulations in force. The manufacturer shall not be held responsible for damages arising from procedures carried out by unauthorized persons which may also void the warranty.



Preparation of location and electrical installation for the product is under customer's responsibility.



DANGER:

The product must be installed in accordance with all local electrical regulations.



DANGER:

Prior to installation, visually check if the product has any defects on it. If so, do not have it installed.

Damaged products cause risks for your safety.

Before installation

The hob is designed for installation into commercially available work tops. A safety distance must be left between the appliance and the kitchen walls and furniture. See figure (values in mm).

- It can also be used in a free standing position. Allow a minimum distance of 750 mm above the hob surface.
- (*) If a cooker hood is to be installed above the cooker, refer to cooker hood manufacturer' instructions regarding installation height (min 650 mm)
- Remove packaging materials and transport locks.
- Surfaces, synthetic laminates and adhesives used must be heat resistant (100 °C minimum).
- The worktop must be aligned and fixed horizontally.
- Cut aperture for the hob in worktop as per installation dimensions.

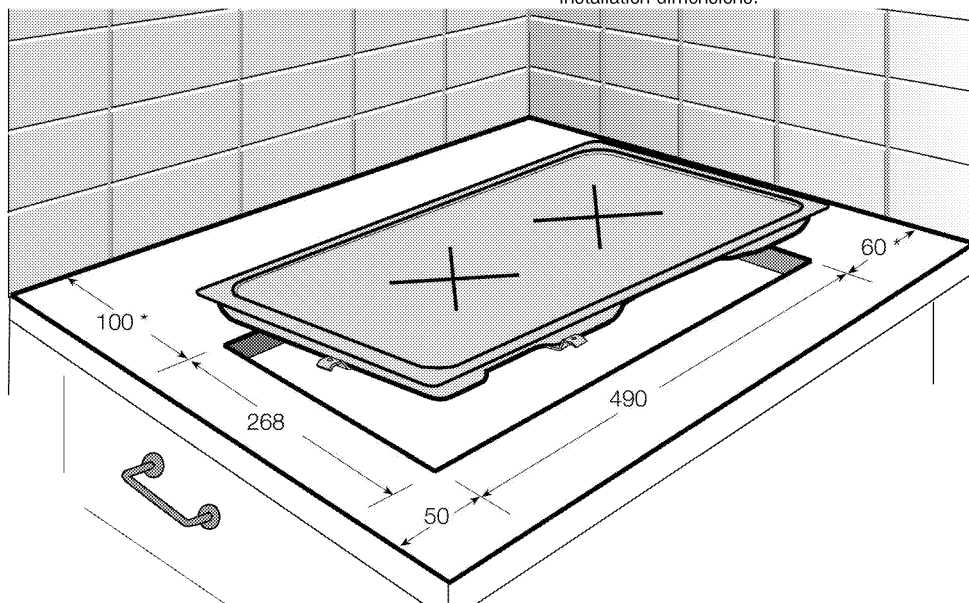

* min.

Installation and connection

- The product must be installed in accordance with all local gas and electrical regulations.



Do not install the hob on places with sharp edges or corners.

There is the risk of breaking for glass ceramic surface!

Electrical connection

Connect the product to a grounded outlet/line protected by a miniature circuit breaker of suitable capacity as stated in the "Technical specifications" table. Have the grounding installation made by a qualified electrician while using the product with or without a transformer. The manufacturer shall not be liable for any damages that will arise due to using the

product without a grounding installation in accordance with the local regulations.



DANGER:

The product must be connected to the mains supply only by an authorised and qualified person. The product's warranty period starts only after correct installation. Manufacturer shall not be held responsible for damages arising from procedures carried out by unauthorised persons.



DANGER:

The power cable must not be clamped, bent or trapped or come into contact with hot parts of the product. A damaged power cable must be replaced by a qualified electrician. Otherwise, there is risk of electric shock, short circuit or fire!

- Connection must comply with national regulations.
- The mains supply data must correspond to the data specified on the type label of the product. Type label is at the rear housing of the product.
- Power cable of your product must comply with the values in "Technical specifications" table.



DANGER:

Before starting any work on the electrical installation, disconnect the product from the mains supply. There is the risk of electric shock!

Connecting the power cable





While performing the wiring, you must apply with the national/local electrical regulations and must use the appropriate socket outlet/line and plug for oven. In case of the product's power limits are out of current carrying capability of plug and socket outlet/line, the product must be connected through fixed electrical installation directly without using plug and socket outlet/line.

1. If it is not possible to disconnect all poles in the supply power, a disconnection unit with at least 3 mm contact clearance (fuses, line safety switches, contactors) must be connected and all the poles of this disconnection unit must be adjacent to (not above) the product in accordance with IEE directives. Failure to obey this instruction may cause operational problems and invalidate the product warranty.

Additional protection by a residual current circuit breaker is recommended.

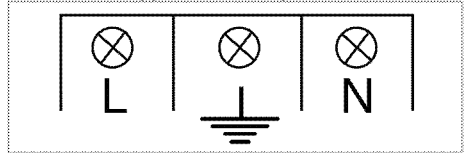
If a cable is supplied with the product:



2. **For single-phase connection**, connect the wires as identified below:
 - Brown/Black cable = L (Phase)
 - Blue/Grey cable = N (Neutral)
 - Green/yellow cable = (E)  (Ground)
- » or
- Grey/Black cable = L (Phase)
 - Blue/Brown cable = N (Neutral)
 - Green/yellow cable = (E)  (Ground)

Installing the product

1. Turning the hob upside down, place it on a flat surface.
2. In order to avoid the foreign substances and liquids penetrate between the hob and the counter, please apply the putty supplied in the package on the contours of the lower housing of the hob but make sure that the putty does not overlap.
3. Fill the corners by forming bends at the corners as illustrated in the figure. Form as much bend as required to fill the gap in the corners.

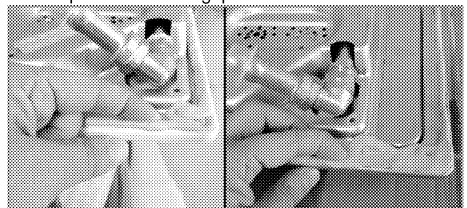

Make sure that the skirting sections on the lower housing of the hob are filled with putty.

4. Place the hob on the counter and align it.



When installing the hob onto a cabinet, a shelf must be installed in order to separate the cabinet from the hob as illustrated in the above figure. This is not required when installing onto a built-under oven.

For example, if it is possible to touch the bottom of the product since it is installed onto a drawer, this section must be covered with a wooden plate.

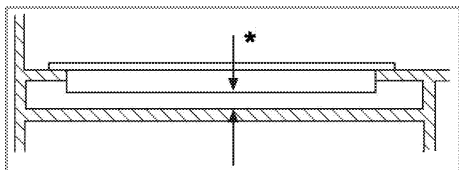

* min. 15 mm

Rear view (connection holes)

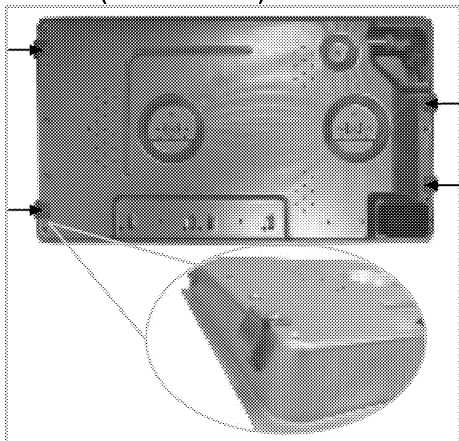

DANGER:

Connection clamps will be supplied as installed onto the hob. Making connections to different holes is not a good practice in terms of safety since it can damage the gas and electrical system.



DANGER:

There are gas and electrical components contained within this hob, therefore when fitting the mounting springs/clamps only attach the supplied fixings to the connection holes shown in this manual. Failure to observe this advise may lead to life and property safety

Final check

1. Operate the product.
2. Check the functions.

4 Preparation

Tips for saving energy

The following information will help you to use your appliance in an ecological way, and to save energy:

- Defrost frozen dishes before cooking them.
- Use pots/pans with cover for cooking. If there is no cover, energy consumption may increase 4 times.
- Select the burner which is suitable for the bottom size of the pot to be used. Always select the correct pot size for your dishes. Larger pots require more energy.
- Pay attention to use flat bottom pots when cooking with electric hobs.
Pots with thick bottom will provide a better heat conduction. You can obtain energy savings up to 1/3.
- Vessels and pots must be compatible with the cooking zones. Bottom of the vessels or pots must not be smaller than the hotplate.
- Keep the cooking zones and bottom of the pots clean. Dirt will decrease the heat conduction between the cooking zone and bottom of the pot.
- For long cookings, turn off the cooking zone 5 or 10 minutes before the end of cooking time. You

can obtain energy savings up to 20% by using the residual heat.

Initial use

First cleaning of the appliance



The surface might get damaged by some detergents or cleaning materials.

Do not use aggressive detergents, cleaning powders/creams or any sharp objects during cleaning.

Do not use harsh abrasive cleaners or sharp metal scrapers to clean the oven door glass since they can scratch the surface, which may result in shattering of the glass.

1. Remove all packaging materials.
2. Wipe the surfaces of the appliance with a damp cloth or sponge and dry with a cloth.

Initial heating



Smoke and smell may emit for a couple of hours during the initial operation. This is quite normal. Ensure that the room is well ventilated to remove the smoke and smell. Avoid directly inhaling the smoke and the smell that emits.

5 How to use the hob

General information about cooking



Never fill the pan with oil more than one third of it. Do not leave the hob unattended when heating oil. Overheated oils bring risk of fire. **Never attempt to extinguish a possible fire with water!** When oil catches fire, cover it with a fire blanket or damp cloth. Turn off the hob if it is safe to do so and call the fire department.

- Before frying foods, always dry them well and gently place into the hot oil. Ensure complete thawing of frozen foods before frying.
- Do not cover the vessel you use when heating oil.
- Place the pans and saucepans in a manner so that their handles are not over the hob to prevent heating of the handles. Do not place unbalanced and easily tilting vessels on the hob.
- Do not place empty vessels and saucepans on cooking zones that are switched on. They might get damaged.
- Operating a cooking zone without a vessel or saucepan on it will cause damage to the product. Turn off the cooking zones after the cooking is complete.
- As the surface of the product can be hot, do not put plastic and aluminum vessels on it. Clean any melted such materials on the surface immediately. Such vessels should not be used to keep foods either.
- Use flat bottomed saucepans or vessels only.
- Put appropriate amount of food in saucepans and pans. Thus, you will not have to make any unnecessary cleaning by preventing the dishes from overflowing. Do not put covers of saucepans or pans on cooking zones. Place the saucepans in a manner so that they are centered on the cooking zone. When you want to move the saucepan onto another cooking zone, lift and place it onto the cooking zone you want instead of sliding it.

Tips about glass ceramic hobs

- Glass ceramic surface is heatproof and is not affected by big temperature differences.

- Do not use the glass ceramic surface as a place of storage or as a cutting board.
- Use only the saucepans and pans with machined bottoms. Sharp edges create scratches on the surface.
- Do not use aluminum vessels and saucepans. Aluminum damages the glass ceramic surface.

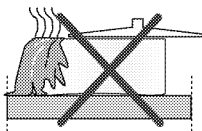

Spills may damage the glass ceramic surface and cause fire.

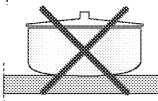

Do not use vessels with concave or convex bottoms.

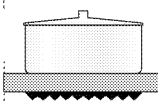

Use only the saucepans and pans with flat bottoms. They ensure easier heat transfer. If the diameter of the saucepan is too small, energy will be wasted.

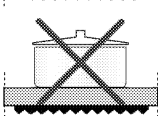

Using the hobs

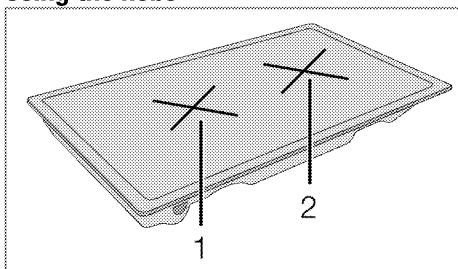

- 1 Single-circuit cooking plate 14-16 cm
- 2 Single-circuit cooking plate 18-20 cm is list of advised diameter of pots to be used on related burners.



DANGER:

Do not allow any object to drop on the hob. Even small objects such as a saltshaker may damage the hob.

Do not use cracked hobs. Water may leak through these cracks and cause short circuit. In case of any kind of damage on the surface (eg., visible cracks), switch off the product immediately to minimize the risk of electric shock.



Graphics and figures are for informational purposes only. Actual appearance or functions may vary.

Control panel

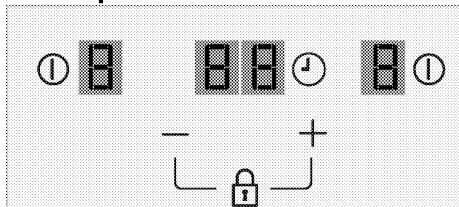

Specifications



Main key - ON/OFF key



Keylock symbol



Temperature setting/Increasing timer



Temperature setting/Decreasing timer



* Enable/disable timer



Cooking zone symbols



Cooking zone display (temperature setting 0 ... 9)

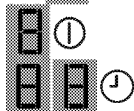

* Timer display (there are 4 LEDs for 4 different cooking zones)



This device is controlled with a touch control panel. Each operation you make on your touch control panel will be confirmed by an audible signal.



Always keep the control panels clean and dry. Humidity and dirt can cause problems in functions.

Turning on the hob

1. Plug in the power cable. When the oven is first powered the "8" appear on all zone display and an audible alarm will sound.

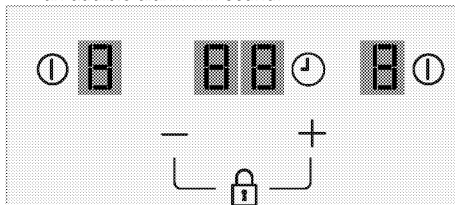

2. After a few second the "8" symbols disappear and "0" appear on front zone display, "1" appear on rear zone display.

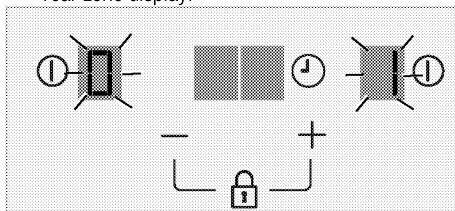

3. After a few second all symbols disappear on all zone display and an audible alarm will sound. and return to Standby mode.

Switching on the cooking zone and adjusting the temperature level

1. On the control panel, touch the "⓪" key of the cooking zone you want to switch on.
» "0" appears on the cooking zone display. Cooking zone is ready for use.

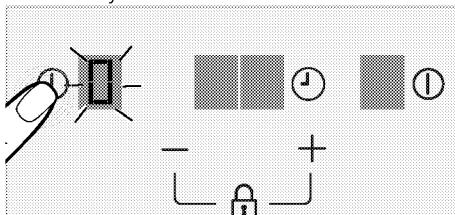

The hob will automatically return to Standby mode if no operation is performed within 10 seconds.

2. Adjust the desired temperature level by touching the "+"/"-" keys. It can be set level to a value between "1" and "9" or between "9" and "1".

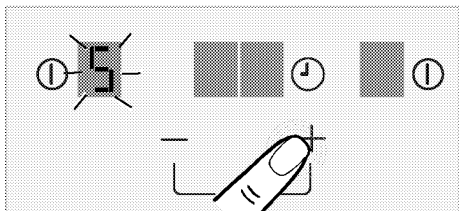

» The relevant cooking zone will start to operate at the set temperature level.

Switching off the cooking zone:

An active cooking zone can be switched off in 3 different ways:

1. **By touching the "0" key of the relevant cooking zone;**

Touch the "0" key of the cooking zone you want to switch off

2. **By dropping the temperature to "0" level;**

You can switch off the cooking zone by adjusting the temperature setting to "0" level.

3. **By using the switching off function on the timer for the desired cooking zone;**

When the time is over, the timer will switch off the cooking zone linked to it. "0" / "00" values and "t" symbol will appear on all displays consecutively.

When the time is over, an audible alarm will sound. Touch any key on the control panel to silence the audible alarm.

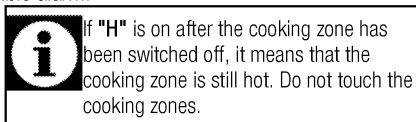

Residual heat indicator

If "H" symbol is flashing on the cooking zone display, it means that the hob is still hot and can be used to keep a small amount of food warm.

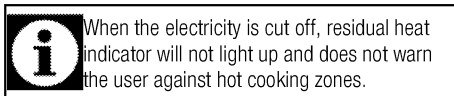

High power setting (BOOSTER)

You can use booster function for rapid heating. When booster is activated, the cooking will operate at maximum power for a certain period of time. Booster time depends on the selected temperature level. However, this function is not recommended for cooking a long time. All cooking zones are equipped with Booster function.

Selecting the high power setting (BOOSTER):

1. Switch on the cooking zone you desire by touching its "0" key.

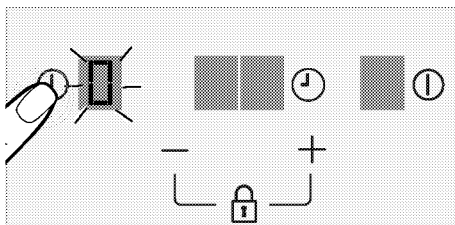

2. Touch "—" key to set the cooking zone temperature value to "P".

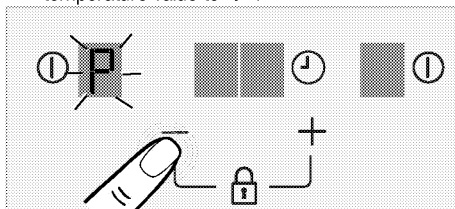

» Selected cooking zone will operate with maximum power and "P" symbol will appear on the cooking zone display. Cooking zone will switch itself off when the booster time is up.

Switching off the high power setting (BOOSTER) prematurely:

1. Touch the "—" key until temperature level decreases "0" to disable the Booster function earlier.

Keylock

You can activate the key lock to avoid changing the functions by mistake when the hob is operating.

Activating the key lock

1. Touch "+" and "—" keys simultaneously for at least 2 seconds while any of the cooking zones is active.

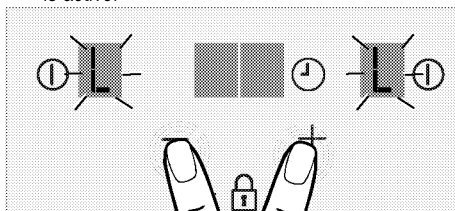

» Only one signal sound will be heard. Key lock function is activated and "L" appears on all cooking zone displays.



You can activate the key lock in the operation mode only. Only the "⌚" key will be functional when the key lock is active. When you touch any other button, "⌚" will blink on all cooking zones to indicate that the key lock is active. If you switch the hob off when the keys are locked, you must deactivate the key lock in order to be able to switch on the hob again.

Deactivating the key lock

1. Touch "+" and "-" keys simultaneously for at least 2 seconds.
» Only one signal sound will be heard. Keylock function is deactivated and "⌚" disappears on all cooking zone displays.

Timer function

This function makes it easier for you to cook. You will not have to watch the hob for the whole cooking period. The cooking zone will be switched off automatically at the end of the time period you have set. The timer value can be selected between 1 and 99 minutes. It is possible for the user to time a cooking zone at any temperature level.

Activating the timer

1. Switch on the cooking zone you desire by touching its "⌚" key.

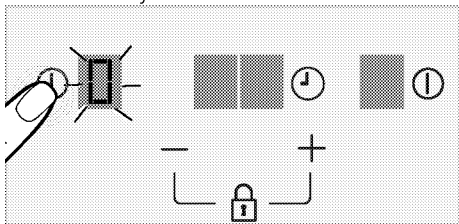

2. Adjust the desired temperature level by touching the "+" and "-" keys.

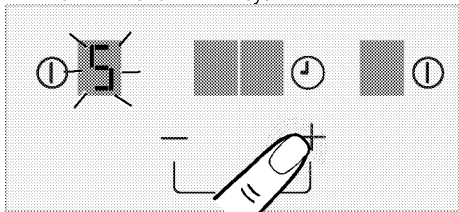

3. Activate the timer by touching the "⌚" key. "⌚" symbols will blink on related the cooking zone's display.

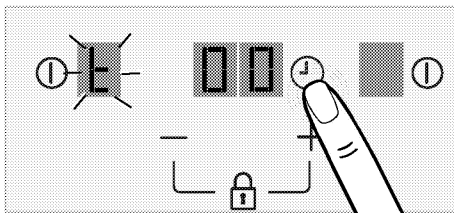

4. Adjust the desired cooking time by touching "+" and "-" keys.

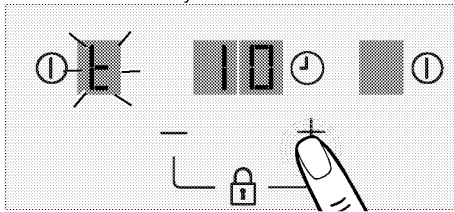

5. After approximately 10 second, the setting will be activated.

» When the time set on the timer has run out, the timed cooking zone is switched off. A timer alarm beep

sounds for one minute. But "⌚" and "00" symbols starts blinking constantly until touch any key.

6. In order to set the timer of the other cooking zone, repeat the process explained above. It is possible to set the timer to both of cooking zones simultaneously. If it is set the timer to both cooking zone, the lower timer value appear on the timer display.



Timer cannot be set without selecting the cooking zone.



If the time is not selected before 10 seconds, the timer is switched off. If the selected time is "00" after 10 seconds the timer is switched off.

Changing the timer

When the timer is in countdown the user can change the time at any time by touching the timer key, the countdown stops and the timer changes to time selection status waiting a time selection.

Deactivating the timers earlier

If you deactivate the timer earlier, the hob will keep on operating at the set temperature until it is switched off. You can deactivate the timer earlier in two different ways:

1. Touch the timer "⌚" key until "00" appears on the display of the cooking zone whose timer is active.

» The timer will be canceled and temperature level reduced to "0" of the related zone.

Operation time limits

The hob control is equipped with an operation time limit. If one or more cooking zones are left on, the cooking zone will automatically be deactivated after a certain period of time (see, Table-1). If there is a timer assigned to the cooking zone, the timer display will also turn off later.

Operation time limit depends on the selected temperature level. Maximum operation time is applied at this temperature level.

The cooking zone may be reactivated by the user after it is switched off automatically as described above.

Table-1: Operation time limits

Temperature level	Operation time limit - hour
0	0
1	10
2	5
3	5
4	4
5	3
6	2
7	2
8	2
9	1
High Power (Booster) Function	1

Overheating protection

Your hob is equipped with some sensors which provide protection against overheating. Following may be observed in case of overheating:

- Operating cooking zone may get switched off.
- Selected level may drop. However, this condition cannot be seen on the indicator.

Error Messages

Table-2: Error codes and error sources

Cause of error	Display
Touch control software error.	F0
Touch control zone is too hot and has turned off all the heaters.	Fc
Touch control temperature sensor can be damaged.	Ft/FE
Excessive sensitivity on any key.	Fb
Security keyboard error	FU / FJ



For further information about error messages that may appear on the touch control panel, see Table-2.



Keep the surface of the touch control panel clean. Erroneous operation may be observed.

6 Maintenance and care

General information

Service life of the product will extend and the possibility of problems will decrease if the product is cleaned at regular intervals.



DANGER:

Disconnect the product from mains supply before starting maintenance and cleaning works.

There is the risk of electric shock!



DANGER:

Allow the product to cool down before you clean it.

Hot surfaces may cause burns!

- Clean the product thoroughly after each use. In this way it will be possible to remove cooking residues more easily, thus avoiding these from burning the next time the appliance is used.
- No special cleaning agents are required for cleaning the product. Use warm water with washing liquid, a soft cloth or sponge to clean the product and wipe it with a dry cloth.
- Always ensure any excess liquid is thoroughly wiped off after cleaning and any spillage is immediately wiped dry.
- Do not use cleaning agents that contain acid or chloride to clean the stainless or inox surfaces and the handle. Use a soft cloth with a liquid detergent (not abrasive) to wipe those parts clean, paying attention to sweep in one direction.



The surface might get damaged by some detergents or cleaning materials.

Do not use aggressive detergents, cleaning powders/creams or any sharp objects during cleaning.

Do not use harsh abrasive cleaners or sharp metal scrapers to clean the oven door glass since they can scratch the surface, which may result in shattering of the glass.



Do not use steam cleaners to clean the appliance as this may cause an electric shock.

Cleaning the hob

Glass ceramic surfaces

Wipe the glass ceramic surface using a piece of cloth dampened with cold water in a manner as not to leave any cleaning agent on it. Dry with a soft and dry cloth. Residues may cause damage on the glass ceramic surface when using the hob for the next time.

Dried residues on the glass ceramic surface should under no circumstances be scraped with hook blades, steel wool or similar tools.

Remove calcium stains (yellow stains) by a small amount of lime remover such as vinegar or lemon juice. You can also use suitable commercially available products.

If the surface is heavily soiled, apply the cleaning agent on a sponge and wait until it is absorbed well. Then, clean the surface of the hob with a damp cloth.



Sugar-based foods such as thick cream and syrup must be cleaned promptly without waiting the surface to cool down. Otherwise, glass ceramic surface may be damaged permanently.

Slight color fading may occur on coatings or other surfaces in time. This will not affect operation of the product.

Color fading and stains on the glass ceramic surface is a normal condition, and not a defect.

Cleaning the control panel

Clean the control panel and knobs with a damp cloth and wipe them dry.



Do not remove the control buttons/knobs to clean the control panel.
Control panel may get damaged!

7 Troubleshooting

Product emits metal noises while heating and cooling.

- When the metal parts are heated, they may expand and cause noise. >>> *This is not a fault.*

Product does not operate.

- The mains fuse is defective or has tripped. >>> *Check fuses in the fuse box. If necessary, replace or reset them.*
- Product is not plugged into the (grounded) socket. >>> *Check the plug connection.*
- If the display does not light up when you switch the hob on again. >>> *Disconnect the appliance at the circuit breaker. Wait 20 seconds and then reconnect it.*



Consult the Authorised Service Agent or technician with licence or the dealer where you have purchased the product if you can not remedy the trouble although you have implemented the instructions in this section. Never attempt to repair a defective product yourself.

