

Dryer

User Manual

Uscător Manual de utilizare Szárító Használati útmutató

DS 8444 RX

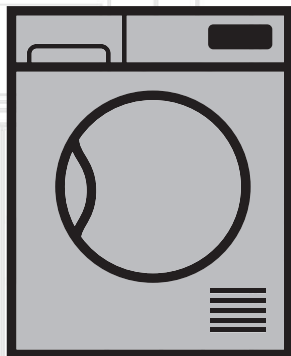

EN | RO | HU

2960312258_EN/251019.1735

beko

Please read this user manual first!

Dear Customer,
Thank you for preferring a Beko product. We hope that your product which has been manufactured with high quality and technology will give you the best results. We advise you to read through this manual and the other accompanying documentation carefully before using your product and keep it for future reference. If you transfer the product to someone else, give its manual as well. Pay attention to all details and warnings specified in the user manual and follow the instructions given therein.
Use this user manual for the model indicated on the cover page.



- Read the instructions.

Explanation of symbols

Throughout this user manual the following symbols are used:



DANGER!

- Warning against electric shock.



DANGER!

- Warning against fire hazard.



WARNING!

- Warning for hazardous situations with regard to life and property.



WARNING!

- Warning against hot surfaces.



WARNING!

- Warning against scalding hazard.



NOTE

- Important information or useful hints about usage.



Packaging materials of the product are manufactured from recyclable materials in accordance with our National Environment Regulations.

Do not dispose of the packaging wastes with the domestic waste or other wastes, discard them to the dedicated collection points designated by the local authorities.



This product was manufactured using the latest technology in environmentally friendly conditions.

1 Important instructions for safety and environment



NOTE

- This section contains safety instructions that will help protect from risk of personal injury or property damage. Failure to follow these instructions shall void any warranty.

1.1 General safety



WARNING!

This appliance can be used by children aged from 8 years and above and persons with reduced physical, sensory or mental capabilities or lack of experience and knowledge if they have been given supervision or instruction concerning use of the appliance in a safe way and understand the hazards involved. Children shall not play with the appliance. Cleaning and user maintenance shall not be made by children without supervision.

Children of less than 3 years should be kept away unless continuously supervised.

- Adjustable feet should not be removed. The gap between the dryer and the floor should not be reduced with materials such as carpet, wood and tape. This will cause problems with the dryer.



WARNING!

Always have the installation and repairing procedures carried out by the Authorized Service. Manufacturer shall not be held liable for damages that may arise from procedures carried out by unauthorized persons.

- Never wash the dryer by spraying or pouring water onto it! There is the risk of electric shock!

For the products with a steam function:



WARNING!

- Use only distilled water or water condensed in the water tank of the machine in steam programs. Do not use mains water or additives. When using condensed water in the water tank, it should be filtered and cleared of fibres.
- Do not open the door when steam programs are running. Hot water may be expelled.
- Before putting laundry in a steam program, stains on it should be removed.
- You may only put laundry that is not dirty or stained but permeated with unpleasant odour in steam (odour removal) program.
- Do not use any dry cleaning sets or additional materials in a steam program or in any program.

1.1.1 Electrical safety



DANGER!

- Electrical safety instructions should be followed while electrical connection is made during the installation.
- Connect the dryer to a grounded outlet protected by a fuse at the value specified on the type label. Have the grounding installation performed by a qualified electrician. Our company shall not be liable for any damages that will arise when the dryer is used without grounding in accordance with the local regulations.
- The voltage and allowed fuse protection is stated on the type label plate.
- The voltage specified on the type label must be equal to your mains voltage.
- Unplug the dryer when it is not in use.
- Unplug the dryer from the mains during installation, maintenance, cleaning and repair works.
- Do not touch the plug with wet hands! Never unplug by pulling on the cable, always pull out by grabbing the plug.



WARNING!

- The appliance must not be supplied through an external switching device, such as a timer, or connected to a circuit that is regularly switched on and off by utility.



DANGER!

- Do not use extension cords, multi-plugs or adaptors to connect the dryer to power supply in order to decrease the risk of fire and electric shock.
- Power cable plug must be easily accessible after installation.
- Damaged mains cable should be changed notifying the Authorized Service.
- If the dryer is faulty, it must not be operated unless it is repaired by an authorized service agent! There is the risk of electric shock!

1.1.2 Product safety



DANGER!

- Superheating of the clothes inside of the dryer can occur if you cancel the programme or in the event of a power failure whilst the dryer is running, this concentration of heat can cause self-combustion and fire so always activate the ventilation programme to cool down or quickly remove all laundry from the dryer in order to hang them up and dissipate the heat.



WARNING!

- Ensure that the air inlet of the dryer is open and it is well-ventilated.
- Product contains R290 refrigerant.
- R290 is an environment-friendly, but flammable refrigerant.
- Keep the product away from potential heat sources that may cause it to ignite.



DANGER!

Points to be taken into consideration for fire hazard:

Below specified laundry or items must not be dried in the dryer considering fire hazard.

- Unwashed laundry items
- Items soiled with oil, acetone, alcohol, fuel oil, kerosene, stain removers, turpentine, paraffin, paraffin removers, petrol, wax or wax removers must be washed in hot water with plenty of detergent before being dried in the dryer.

For this reason especially the items containing the above specified stains must be washed very well, to do this use adequate detergent and choose a high washing temperature.

Below specified laundry or items must not be dried in the dryer due to the fire hazard:

- Garments or pillows bolstered with rubber foam (latex foam), shower bonnets, water resistant textiles, materials with rubber reinforcement and rubber foam pads.

Clothing cleaned with industrial chemicals.

Items such as lighter, match, coins, metal parts, needle etc. may damage the drum set or may lead to functional problems. Therefore check all the laundry that you will load into your dryer.



WARNING!

Never stop your dryer before the programme completes. If you must do this, remove all laundry quickly and lay them out to dissipate the heat.



DANGER!

- Clothes that are washed inadequately may ignite on their own and even may ignite after drying ends.
- You must provide enough ventilation in order to prevent gases exiting from devices operating with other types of fuels including the naked flame from accumulating in the room due to the back fire effect.



WARNING!

- Underwear that contains metal reinforcements should not be dried in the dryer. Dryer may be damaged if metal reinforcements come loose and break off during drying.



NOTE

- Use softeners and similar products in accordance with the instructions of their manufacturers.

Always clean the lint filter before or after each loading. Never operate the dryer without the lint filter installed.



WARNING!

- Never attempt to repair the dryer by yourself. Do not perform any repair or replacement procedures on the product even if you know or have the ability to perform the required procedure unless it is clearly suggested in the operating instructions or the published service manual. Otherwise, you will be putting your life and others' lives in danger.
- There must not be a lockable, sliding or hinged door that may block the opening of the loading door in the place where your dryer is to be installed.
- Install your dryer at places suitable for home use. (Bathroom, closed balcony, garage etc.)
- Make sure that pets do not enter the dryer. Check the inside of the dryer before operating it.
- Do not lean on the loading door of your dryer when it is open, otherwise it may fall over.
- The lint must not be allowed to accumulate around the tumble dryer
- The tumble dryer is not to be used if industrial chemicals have been used for cleaning.
- Fabric softeners, or similar products, should be used as specified by the fabric softener instructions.
- Exhaust air must not be discharged into a flue which is used for exhausting fumes from appliances burning gas or other fuels.

1.2 Mounting over a washing machine

- A fixing device should be used between the two machines when installing the dryer above a washing machine. The fitting device must be installed by the authorized service agent.
- Total weight of the washing machine and the dryer -with full load- when they are placed on top of each other reaches to approx. 180 kilograms. Place the products on a solid floor that has sufficient load carrying capacity!



WARNING!

- Washing machine cannot be placed on the dryer. Pay attention to the above warnings during the installation on your washing machine.

Installation Table for Washing Machine and Dryer

Dryer Depth	Washing Machine Depth			
	62 cm	60 cm	54 cm	< 50 cm
54 cm	Can be installed		Cannot be installed	
60 cm	Can be installed		Cannot be installed	

1.3 Intended use

- Dryer has been designed for domestic use. It is not suitable for commercial use and it must not be used out of its intended use.
- Use the dryer only for drying laundry that are marked accordingly.
- The manufacturer waives any responsibility arisen from incorrect usage or transportation.
- The service life of the dryer that you purchased is 10 years. During this period, original spare parts will be available to operate the dryer properly.

1.4 Child safety

- Packaging materials are dangerous for the children. Keep packaging materials away from children.
- Electrical products are dangerous for the children. Keep children away from the product when it is operating. Do not let

them tamper with the dryer. Use the child-proof lock in order to prevent the children to tamper with the dryer.



NOTE

Child-proof lock is on the control panel.
(See Child lock)

- Keep loading door closed even when the dryer is not in use.

1.5 Compliance with the WEEE regulation and disposing of the waste product



This product complies with EU WEEE Directive (2012/19/EU). This product bears a classification symbol for waste electrical and electronic equipment (WEEE).

This product has been manufactured with high quality parts and materials which can be reused and are suitable for recycling. Do not dispose of the waste product with normal domestic and other wastes at the end of its service life. Take it to the collection center for the recycling of electrical and electronic equipment. Please consult your local authorities to learn about these collection centers.



DANGER!

- R290 is an flammable refrigerant. Thus, ensure that the system and the pipes are not harmed during operation and handling.
- Keep the product away from potential heat sources that may cause it to ignite in case of damage.
- Do not dispose of the product by putting it in fire.

1.6 Compliance with RoHS Directive:

The product you have purchased complies with EU RoHS Directive (2011/65/EU). It does not contain harmful and prohibited materials specified in the Directive.

1.7 Package information

Packaging materials of the product are manufactured from recyclable materials in accordance with our National Environment Regulations. Do not dispose of the packaging materials together with the domestic or other wastes. Take them to the packaging material collection points designated by the local authorities.

1.8 Technical Specifications

EN

Height (Min. / Max.)	84,6 cm / 86,6 cm*
Width	59,7 cm
Depth	58,9 cm
Capacity (max.)	8 kg**
Net weight (± 4 kg)	44 kg
Voltage	See type label***
Rated power input	
Model code	

* Min. height: Height with adjustable feet are closed.

Max. height: Height with adjustable feet are opened maximum.

** Dry laundry weight before washing.

*** Type label is located behind the loading door.



NOTE

- Technical specifications of the dryer are subject to specification without notice to improve the quality of the product.
- Figures in this manual are schematic and may not match the product exactly.
- Values stated on markers on the dryer or in the other published documentation accompanying with the dryer are obtained in laboratory in accordance with the relevant standards. Depending on operational and environmental conditions of the dryer, these values may vary.





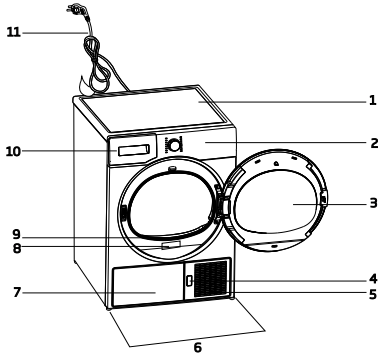

2 Your Dryer

2.1 Overview

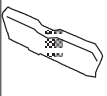

1. Top panel
2. Control panel
3. Loading door
4. Kick plate opening button
5. Ventilation grids
6. Adjustable legs
7. In models where the tank is placed below, the water tank is inside the toe board
8. Type label
9. Lint filter
10. Water tank drawer (in models where the tank is placed above)
11. Power cord

2.2 Package Contents

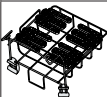
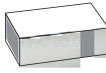
	1. Water drain hose *		5. Drying basket user manual*
	2. Filter drawer spare sponge*		6. Water Filling Container*
	3. User Manual		7. Pure Water*
	4. Drying basket*		8. Fragrance Capsules Group*

*Optional - may not be included, depends on model.

3 Installation

Before the calling the nearest Authorized Service for the installation of the dryer, ensure that electrical installation and water drain is appropriate referring to the user's manual. If they are not suitable, contact a qualified electrician and technician to make necessary arrangements.



NOTE

- Preparation of the dryer's location as well as the electrical and waste water installations is under customer's responsibility.



WARNING!

- Prior to installation, visually check if the dryer has any defects on it. If the drier is damaged, do not have it installed. Damaged products cause risks for your safety.
- Let your dryer wait for 12 hours before starting to use it.

3.1 Appropriate installation location

Install the dryer on a stable and level surface. Dryer is heavy. Do not move it by yourself.

- Operate your dryer in a well ventilated, dust-free environment.
- The gap between the dryer and the surface should not be reduced by the materials such as carpet, wood and tape.
- Do not cover the ventilation grills of the dryer.
- There must not be a lockable, sliding or hinged door that may block the opening of the loading door in the place where your dryer is to be installed.
- Once the dryer is installed, it should stay at the same place where its connections have been made. When installing the dryer, make sure that its rear wall does not touch anywhere (tap, socket, etc.).
- Place the dryer at least 1 cm away from the edges of other furniture.
- Your dryer can be operated at temperatures between +5°C and +35°C. If the operating conditions fall outside of this range, operation of the dryer will

be adversely affected and it can get damaged.

- The rear surface of the tumble dryer shall be placed against a wall.



DANGER!

Do not place the dryer on the power cable.

*** Ignore following warning if your product's system does not contains R290.**



DANGER!

- Dryer contains R290 refrigerant.*
- R290 is an environment-friendly, but flammable refrigerant.*
- Ensure that the air inlet of the dryer is open and it is well-ventilated.*
- Keep potential flame sources away from the dryer.*

3.2 Removing the transportation safety assembly



WARNING!

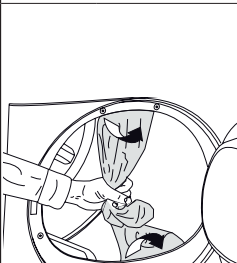

- Remove the transportation safety assembly before using the dryer for the first time.
- If the door swing side of your appliance can be modified, see the reversible door mounting instructions.

3.3 Connecting to the drain

You can directly drain accumulated water through the water drain hose supplied with the product instead of periodically draining the water collected in the water tank.

Connecting the water drain hose

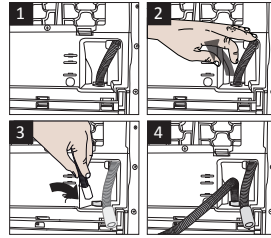

1-2 Pull hose at the behind of the dryer by hand in order to disconnect it from where it is connected. Do not use any tools to remove the hose.

- 3 Connect one end of the drain hose supplied with the dryer to the connection point from where you removed the hose of the product in previous step.
- 4 Connect the other end of the drain hose directly to the wastewater drain or to the washbasin.



NOTE

- Water drain hose should be attached to a height of maximum 80 cm.
- Make sure that the water drain hose is not stepped on and it is not folded between the drain and the machine.
- If there is an accessories pack supplied with your product, please see the detailed description.

3.4 Adjusting the feet

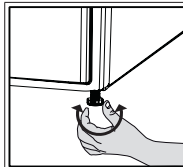

- Turn the feet to left or right until the dryer stands level and firmly.

3.5 Transportation of the dryer

Drain all water that has remained in the dryer. If direct water drain connection is made, then remove the hose connections.



WARNING!

- We recommend carrying the dryer in upright position. If it is not possible to carry the machine in the upright position, we recommend carrying it by tilting towards the right side when looked from the front.

3.6 Warnings about sounds



NOTE

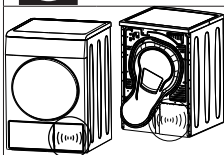

- It is normal to hear a metallic noise from the compressor sometimes during operation.

- Water collected during operation is pumped to water tank. It is normal to hear pumping noise during this process.

3.7 Changing the illumination lamp

In case an illumination lamp is used in your laundry dryer. To change the Bulb/LED used for illumination of your tumble dryer, call your Authorized Service. The lamp(s) used in this appliance is not suitable for household room illumination. The intended purpose of this lamp is to assist the user to place laundry in the tumble dryer in a comfortable way. The lamps used in this appliance have to withstand extreme physical conditions such as vibrations and temperatures above 50 °C

4 Preparation

4.1 Laundry suitable for drying in the dryer

Always obey the instructions given on the garment tags. Dry only the laundry having a label stating that they are suitable for drying in a dryer.

4.2 Laundry not suitable for drying in the dryer



Do not dry with dryer

Items with this symbol should not be dried in the dryer.

i NOTE

- Delicate embroidered fabrics, woollen, silk garments, delicate and valuable fabrics, airtight items and tulle curtains are not suitable for machine drying.

4.3 Preparing laundry for drying

- Laundry may be tangled with each other after washing. Separate the laundry items before placing them into the dryer.
- Dry garments having metal accessories such as zippers, inside out.
- Fasten the zippers, hooks and buckles and button sheets.

4.4 Things to be done for energy saving

- Spin your laundry at the highest speed possible when washing them. Thus, the drying time is shortened and energy consumption is reduced.
- Sort out the laundry depending on their type and thickness. Dry the same type of laundry together. For example thin kitchen towels and tableclothes dries earlier than thick bathroom towels.
- Follow the instructions in the user manual for programme selection.
- Do not open the loading door of the machine during drying unless necessary. If you must open the loading door, do not keep it open for a long time.
- Do not add wet laundry while the dryer is in operation

- For models with a condenser unit: clean the condenser once in a month or after every 30 operations regularly. .
- Clean the filter periodically. Read the Maintenance and cleaning of filters for detailed information.
- For models with flue unit: comply with the flue connection instructions and clean the flue.
- During the drying process, air the room well where your tumble dryer is operating.

4.5 Correct load capacity

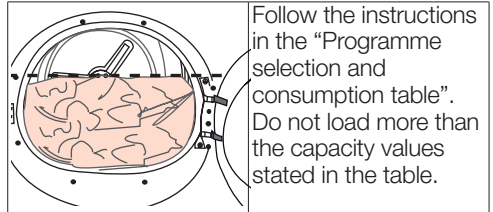

Following weights are given as examples.

Laundry	Approximate weights (g)*	Laundry	Approximate weights (g)*
Cotton quilt covers (double)	1500	Blouses	150
Cotton quilt covers (single)	1000	Cotton shirts	300
Bed sheets (double)	500	Shirts	250
Bed sheets (single)	350	Cotton dresses	500
Large tablecloths	700	Dresses	350
Small tablecloths	250	Jeans	700
Tea napkins	100	Handkerchiefs (10 pieces)	100
Bath towels	700	T-Shirts	125
Hand towels	350		

*Dry laundry weight before washing.

5 Operating the product

5.1 Control Panel

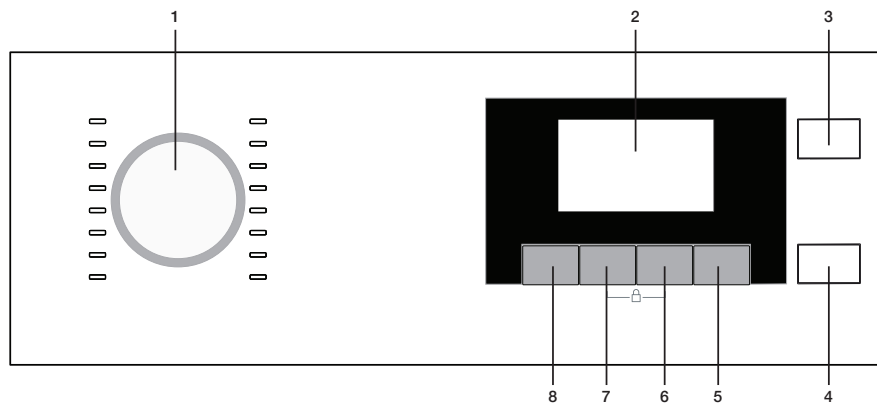

- 1. Program Selection button
- 2. Display
- 3. On-Off button
- 4. Start/Stand-by button

- 5. End Time button
- 6. Time Programs Adjusting button
- 7. Audio Warning Level button
- 8. Dryness Settings Selection button

5.2 Screen symbols

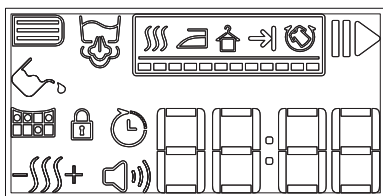
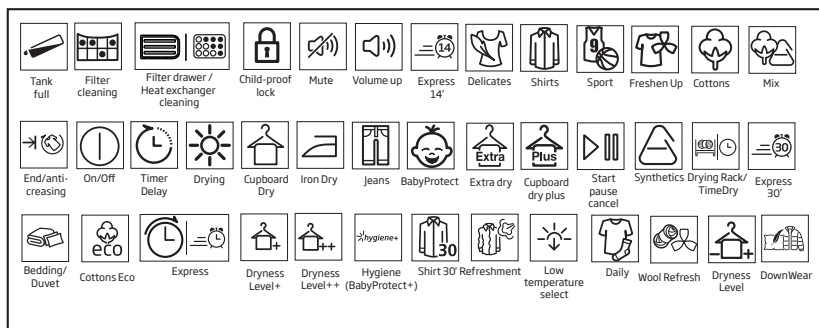

- Buzzer level symbol
- Clean filter drawer warning symbol
- Filter cleaning warning symbol
- Water tank warning symbol
- End of cycle
- Start/hold symbol
- Steam symbol
- Dryness level
- Iron-dry
- Closet-dry
- Child lock warning symbol
- Anti-crease
- End time
- Remaining time indicator*

*Time displayed indicates the remaining time to the end of the cycle and this time varies as per the humidity of the laundry.

5.3 Preparing the dryer

Plug in the tumble dryer

Open device door.

Place the laundry into the tub in a slight loosely.

Close the door by pushing.

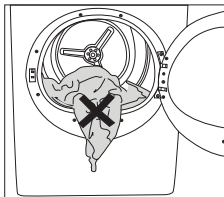

NOTE

- Make sure there is nothing door and the device while closing the door.

Press and hold **On/Off/Cancel** button for 1 second.

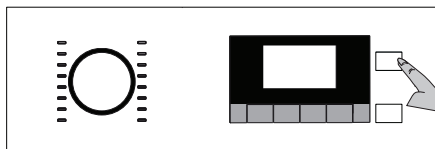

- When dryer is used for the first time, declaration program (cupboard dry cottons) is selected.



NOTE

- Program doesn't start immediately only by pressing the **On/Off/Cancel** button. Start the program with the **On/Off/Cancel** button after program selection.

5.4 Program selection

Your dryer has 16 different programs.

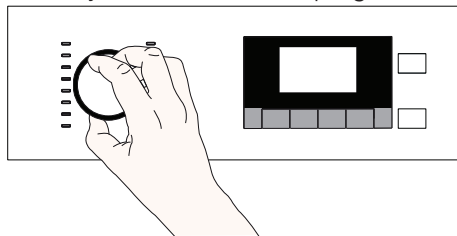

- Select the desired program by turning the program selection button..
- Displayed program selection and consumption chart are based on sorting by preferences of majority of users.

5.5 Program selection and consumption chart

EN				
Programmes	Programme Description	Capacity (kg)	Spin speed in washing machine (rpm)	Drying Time (minutes)
Cottons Iron Dry	You may dry your cotton laundry to be ironed in this program to have them slightly damp for ease of ironing. (Shirt, T-shirt, tablecloth, etc.)	8	1000	145
Cottons Eco	You may dry all your cotton laundry in this program. (T-shirt, pants, pyjamas, baby clothes, underwear, linen, etc.) You can put your laundry in the wardrobe without ironing.	8	1000	197
Cottons Cupboard Dry	You may use this program for extra dryness in thick laundry such as pants, tracksuit. You can put your laundry in the wardrobe without ironing.	8	1000	205
Cottons Extra Dry	You may dry your thick cotton laundry in this program such as towels, bathrobe, etc. You can put your laundry in the wardrobe without ironing.	8	1000	210
Synthetics Iron Dry	You may dry your synthetic laundry to be ironed in this program to have them slightly damp for ease of ironing. (Shirt, T-shirt, tablecloth, etc.)	4	800	60
Synthetics Cupboard Dry	You may dry all your synthetic laundry in this program. (Shirt, T-shirt, underwear, tablecloth, etc.) You can put your laundry in the wardrobe without ironing.	4	800	70
Drying Rack/ TimeDry	You may select from time programmes between 10 and 160 minutes to achieve the desired drying level at low temperature. In this programme, tumble drier's operation lasts for the set time independently from the dryness of laundry. This product is available to be used with a drying basket as option. For products that are sold without a basket, you can obtain a basket from an authorized service and use the drying programs specified above. For details of use, see the drying basket user guide.	-	-	-
Freshen Up	Ventilates for 10 minutes without blowing hot air. You can ventilate the cotton and linen clothes that have been enclosed for a long time with this program to remove their odour. You can use this program to ventilate and soften wool laundry that can be washed in a washing machine. Do not use for full drying.	-	-	10
Delicates	You may dry your delicate laundry or laundry with hand wash symbol (silk blouses, thin underwear, etc.) at low temperature in this program.	1,5	1200	70
Jeans	You may dry denim pants, skirts, shirts or jackets in this program.	4	1200	150
Outdoor/Sports	Use it to dry your clothes made of synthetics, cotton or mixed fabrics or waterproof products such as functional jacket, raincoat etc. Turn them inside out prior to drying.	2	1000	135
Mix	You can dry both cotton and synthetic laundry with this programme. Sports and fitness clothes may be dried with this program.	4	1000	125

Shirts	It dries the shirts in a more sensitive manner, and causes less creasing and easier ironing.	1,5	1200	60
Hygiene +	It is a long-term program that you can use for the clothes (baby clothes, towels, underwear, etc. cotton) you require hygiene. Hygiene is provided with high temperature. It is especially suitable for durable fabrics. ((This program is identified and approved by England's "The British Foundation" (Allergy UK).))	5	800	185
Duvet DownWear	You can dry your feather or fibre filled textile that bears can be dried in drier label as a single piece of laundry. You can dry double duvet, pillow or coats as single piece of laundry. Dry your cloths such as coats and jackets turned inside out.	-	800	165
Daily Express	Use this program to have 2 shirts ready for ironing.	0,5	1200	30
Energy consumption values				
Programmes	Capacity (kg)	Spin speed in washing machine (rpm)	Approximate amount of remaining humidity	Energy consumption value kWh
Cottons Eco *	8	1000	60%	1,97
Cottons Iron dry	8	1000	60%	1,5
Synthetics cupboard dry	4	800	40%	0,75
	"Cottons Eco programme" used at full and partial load is the standard drying programme to which the information in the label and the fiche relates, that this programme is suitable for drying normal wet Cottons laundry and that it is the most efficient programme in terms of energy consumption for Cottons.			



NOTE

- When the program ends for not having wrinkles on your delicate laundry, take out your laundry immediately and hang them.
- To get better results from drying machine programs, your laundry should be washed with suitable program in your washing machine and wrung with recommended wringing speed.
- Shirt might remain slightly damp at the end of the program. It is recommended not to leave the shirts inside the drying machine.

* : Energy Label standard program (EN 61121:2012)

All the values on the chart are identified according to EN 61121:2012 standard. Consumption values may vary from the valued in the chart depending on laundry type, wringing speed, ambient conditions and voltage levels.



Allergy UK is the brand of the British Allergy Association. Seal of Approval is created to guide people that require recommendation about a product that the related

product restricts / reduces / eliminates the allergens or reduces the allergen content significantly in the ambient where allergy patients exist. It aims to provide assurance that the products are tested scientifically or examined in a way to provide measurable results.

5.6 Auxiliary functions

Audible warning

Machine makes an audible warning when the program is completed. To adjust the sound level, use the Sound Warning Level button.



NOTE

- You can change the sound level before the program starts or while the program continues..

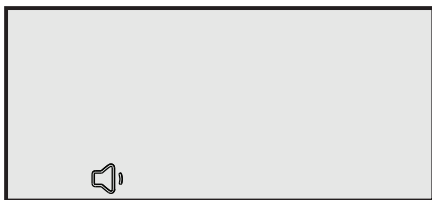
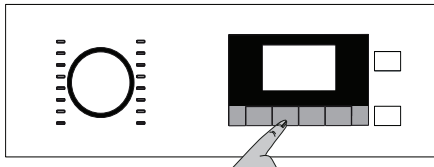

Volume level low

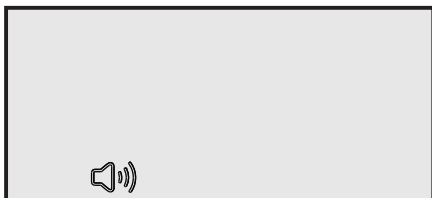

Volume level high

Dryness settings selection

Dryness settings button is used for adjusting to desired dryness. Program time may change depending on the selection.



NOTE

- You can activate this function only prior to start of program.

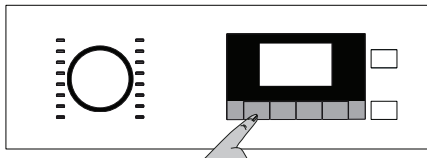

Drying level damp



Drying level normal



Drying level extra

5.7 Warning symbols



NOTE

- Warning symbols may vary depending on the model of your machine.

Fibre filter cleaning

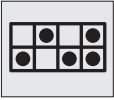

When the program is completed, the warning symbol for filter cleaning turns on.



NOTE

- For detailed information, See 6 Maintenance and cleaning.
- If filter cleaning symbol constantly flashes See.7 Troubleshooting.

Emptying the water tank

When the program is completed, the warning symbol to empty the water tank turns on.



NOTE

- For detailed information, See 6 Maintenance and cleaning.

If the water tank fills up while the program continues, the warning symbol starts flashing and the machine goes into stand-by. In this case, empty the water tank and start the program by pressing the Start / Stand-by button. Warning symbol turns off and program resumes.



Cleaning the filter drawer

Warning symbol flashes periodically to remind that filter drawer must be cleaned.



NOTE

- For detailed information, See 6 Maintenance and cleaning.



Loading cover is open

If loading cover of the dryer is open while drying, Stand-by symbol turns on and program progress symbol flashes.

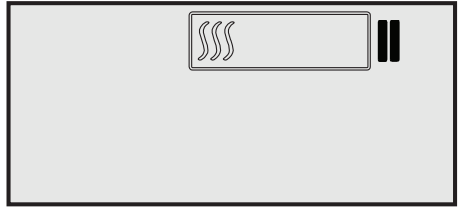

End time

You can delay the end time of the program up to 24 hours with end time function.

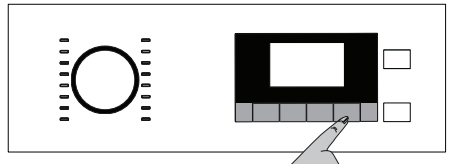

- Open the loading door and place the laundry.
- Select drying program, spin cycle and if needed, additional functions.
- Press the End Time selection button and set the delay time you wish. End Time symbol turns on. (When pressed and hold the button, End Time proceeds non-stop).
- Press the Start / Stand-by button. End time countdown starts and Start symbol turns on. “:” Separator in the middle of displayed delay time flashes.

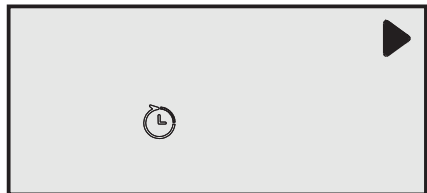

NOTE

- You can add or remove laundry within end time. End Time symbol will turn off at the end of countdown, drying starts and duration of program is displayed. Displayed time is the sum of normal drying time and end time.

Changing the end time

If you want to change the duration during the countdown:

- Press the **On/Off/Cancel** button for 3 seconds to cancel the program. Turn on the machine again and repeat the Delay Setting process for the duration you wish.
- When your machine is turned on for the first time, it turns on with the declaration program (cotton wardrobe dry).

Cancelling the end time function

If you want to cancel the end time countdown and start the program immediately:

- Press the **On/Off/Cancel** button for 3 seconds to cancel the program.
- Press the **On/Off/Cancel** button to start you previously selected program.

5.8 Starting the program

Press the ► Start/Stand-by button to start the program.

Indicating start of the program, Start symbol turns on, “:” separator in the middle of remaining time keeps flashing. Program

Progress Symbol turns on.

5.9 Program progress status

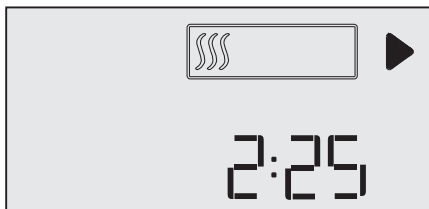

5.10 Child Lock

The machine has a child lock which prevents the program flow from being interrupted when the buttons are pressed during a program. To activate the child lock

- Press and hold time programs and audio warning buttons for 3 seconds.
- When the child lock is activated, the lock symbol on the screen turns on.

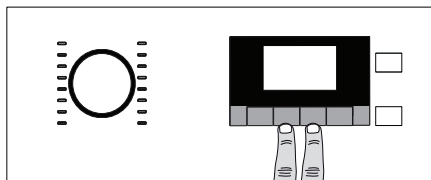

- When the child lock is activated, all buttons on the panel except the On/Off/Cancel and Child Lock buttons are deactivated.
- When the child lock is activated, indicator symbols don't change if the position of Program Selection button is changed. When Program Selection button is turned and function buttons are pressed, the letters “CL” flashes on the screen.



- The child lock has to be deactivated to be able to start a new program after the current program is finished or to be able to interfere with the program.

To Deactivate The Child Lock:

- Press and hold the child lock button for 3 seconds.
- Child lock deactivates when the dryer is turned off and on by the **On/Off/Cancel** button.

5.11 Changing the program after it is started

You can change the program you selected to dry your laundry with a different program after the machine starts running.

- For example, to select Extra Dry instead of Iron Dry, pause the program by pressing the Start / Stand-by button.

- Select the Extra Dry program using the Program Selection button.
- Press the Start/Stand-by button to start the program.

Adding and removing clothes during stand-by

- If you want to add or remove clothes to/from the machine after the drying program starts:
- Press the Start/Stand-by button to put the machine in Stand-by state. The drying operation stops.
- Open the loading door while in Stand-by state, and close the door after you remove or add laundry.
- Press the Start/Stand-by button to start the program.

	NOTE
<ul style="list-style-type: none"> • Adding laundry after the drying operation starts may cause the dried laundry inside the machine to mix with wet laundry and leave the laundry damp at the end of operation. • Adding or removing laundry during drying may be repeated as many times as you wish. But this operation continuously interrupts the drying operation, and thus increases program duration and energy consumption. So, it is recommended to add laundry before the program starts. • If a new program is selected by turning the program selection knob while the machine is in stand-by; the running program terminates and new program information is displayed on the screen. 	

	WARNING!
<ul style="list-style-type: none"> • Do not touch the inner surface of the drum while adding or removing clothes during a continuing program. The drum surface is hot. 	

5.12 Cancelling the program

If you want to cancel the program and terminate the drying operation for any reason after the machine starts running, keep the **On/Off/Cancel** button pressed for 3 seconds.

	WARNING!
<ul style="list-style-type: none"> • The inside of the machine shall be extremely hot when you cancel the program during machine operation, so run the ventilation program to allow it to cool down. 	

5.13 End of program

When the program ends, the Fibre Filter Cleaning and Water Tank warning symbols on the program observation indicator turn on. Loading door may be opened and machine becomes ready for another run.

To turn off the machine, press the **On/Off/Cancel** button.

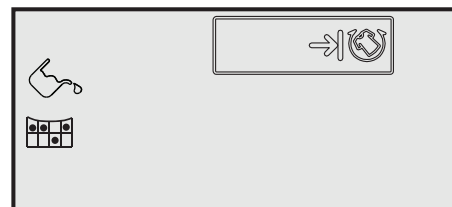

	NOTE
<ul style="list-style-type: none"> • Wrinkle Prevention function activates the 2 hour-Wrinkle Prevention program if laundry isn't taken out of machine after completion of the program. • Clean the fibre filter after each drying. See 6.1 Cleaning Lint Filter / Loading Door Inner Surface • Empty the water tank after each drying. See 6.3 Draining the water tank 	

5.14 Odor Feature

Read the ProScent manual for the use of this feature if your dryer has odor application capability.

6 Maintenance and cleaning

6.1 Loading Door Inner Surface

The hair and fibres that are separated from the laundry during drying process is collected by the Fibre Filter.



NOTE

- Fibres are formed during wearing and washing clothes.
- You can clean the filter slot with a vacuum cleaner.



WARNING!

- After each drying cycle, clean the fibre filter and the inner surface of the loading door.

To clean the fibre filter:

- Open the loading door.
- Hold the first part (inner filter) of the two part fibre filter and remove it by pulling it upwards.
- Collect the hair, fibres and cotton balls with hand or with a soft cloth.
- Remove the second part (outer filter) by pulling it upwards.

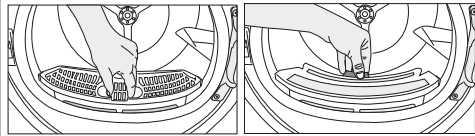

NOTE

- Ensure that hair, fibre and cotton balls do not fall into the slot where the filters are installed.

- Open both fibre filters (inner and outer filters) remove the hair, fibre, cotton balls with your damp hand or a vacuum cleaner or a cloth.

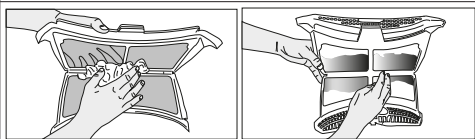

- Clean both filters under water running in reverse direction of fibre accumulation or with a soft brush. Dry the filter before placing it back.

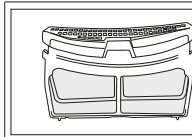
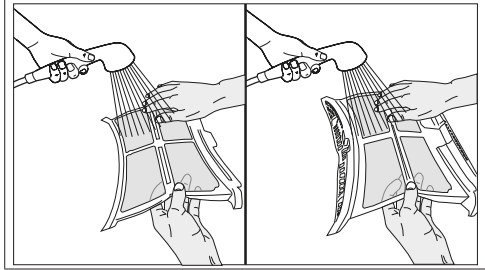

- Insert the fibre filters on one another and place it back in its place.

- Clean the loading door interior and its washer with a soft damp cloth.

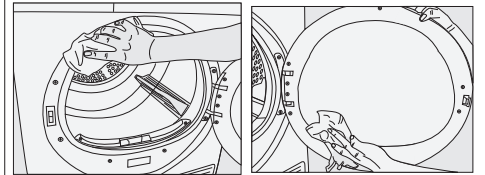

6.2 Cleaning the sensor

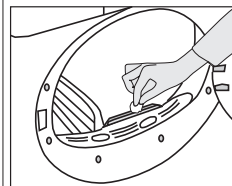

There are dampness sensors in the dryer that detect whether the laundry is dry or not. To clean the sensors:

- Open the loading door of the dryer.
- Allow the machine to cool down if it is still hot due to the drying process.
- Wipe the metal surfaces of the sensor with a soft cloth, dampened with vinegar and dry them.



NOTE

- Clean metal surfaces of the sensors 4 times a year.
- Do not use metal tools when cleaning metal surfaces of the sensors.

- If there is lint accumulation in the funnel of the water tank, clean it under running water.
- Place the water tank into its seat.



WARNING!

- Never use solvents, cleaning agents or similar substances for cleaning due to the risk of fire and explosion!



NOTE

- If the direct water draining is used as an option, there is no need to empty the water tank.

6.3 Draining the water tank

Dampness of the laundry is removed and condensed during drying process and the water that arise accumulates in the water tank. Drain the water tank after each drying cycle.



WARNING!

- Condensed water is not drinkable!
- Never remove the water tank when the program is running!

If you forget to drain the water tank, the machine will stop during the subsequent drying cycles when the water tank is full and the Water Tank warning symbol will flash. If this is the case, drain the water tank and press Start / Pause button to resume the drying cycle. To drain the water tank:

1. Remove the water tank in the drawer or container carefully.

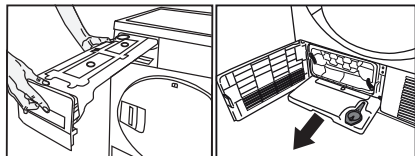

2. Drain the water in the tank.

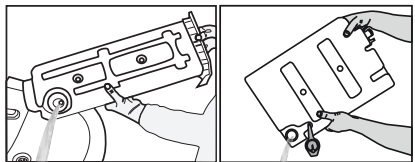

6.4 Cleaning the evaporator

The hair and fibres that are not caught by the fibre filter goes to the fins of the evaporator behind the toe board and accumulates here. If the evaporator "🌀" icon is flashing or in 6 month periods, clean the evaporator.

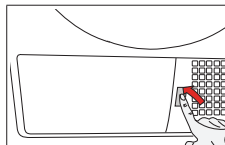

- Open the toe board by pressing on it.

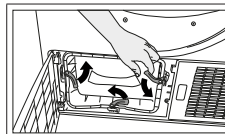

- To open the air routing door, move the release latch.

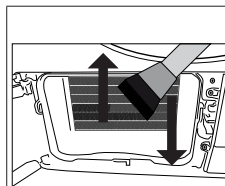

- Clean the fibres on the evaporator with a damp cloth / vacuum cleaner with a brush by moving upwards and downwards.

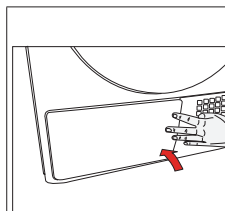

- After the cleaning process is completed, place the air router door to its place, move the latches to close it and close the toe board.



WARNING!

- You can clean by hand, provided you wear protective gloves. Do not try to clean with bare hands. Evaporator fins may damage your hands.
- Cleaning by left to right movements may damage the evaporator fins. This may lead to drying issues.

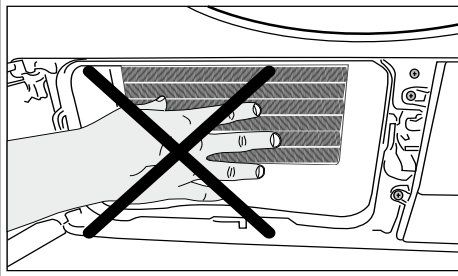

7 Troubleshooting

Drying operation takes too long.

Fibre filter (interior and exterior filter) pores may be clogged. >>> Wash the fibre filters with warm water and dry. Evaporator front side may be clogged. >>> Clean the front side of the evaporator.

The ventilation grills in front of the machine may be closed. >>> Remove any object in front of the ventilation grills that blocks air.

Ventilation may be inadequate because the are the machine is installed in is too small. >>> Open the door or windows to prevent the room temperature from rising very high.

A lime layer may have accumulated on the humidity sensor. >>> Clean the humidity sensor.

Excessive amount of laundry might be loaded. >>> Do not load the drying machine excessively.

Laundry might not have been wrung adequately. >>> Perform a higher speed wringing on the washing machine.

Clothes come out damp after drying.

A program not suitable for the laundry type may have been used.>>> Check the maintenance labels on the clothes and select a program suitable for the clothes' type or use time programs as extra.

Fibre filter (interior and exterior filter) pores may be clogged. >>> Wash the filters with warm water and dry.

Evaporator front side may be clogged. >>> Clean the front side of the evaporator.

Excessive amount of laundry might be loaded. >>> Do not load the drying machine excessively.

Laundry might not have been wrung adequately. >>> Perform a higher speed wringing on the washing machine.

Drying machine does not turn on or program cannot be started. Drying machine does not run after it is configured.

Power plug might be unplugged. >>> Make sure the power cord is plugged in.

Loading door might be open. >>> Ensure that the loading door is properly closed.

A program might not be set or Start / Pause /Cancel button might not be pressed. >>> Check that the program is set and it is not in Pause position..

Child lock may be activated. >>> Turn off the child lock.

Program terminated prematurely for no reason.

Loading door might be closed completely. >>> Ensure that the loading door is properly closed.

There might be a power outage. >>> Press the Start / Pause / Cancel button to start the program.

Water tank may be full. >>> Empty the water tank.

Clothes have shrunk, hardened or spoiled.

A program not suitable with the laundry type might have been used. >>> Check the maintenance labels on the clothes and select a program suitable for the clothes.

Water drips from the loading door.

Fibres might have gathered on the inner sides of the loading door and the loading door gasket. >>> Clean the inner surfaces of the loading door and the loading door gasket surfaces.

Loading door opens by itself.

Loading door might be closed completely. >>> Push the loading door until the closing sound is heard.

Water tank warning symbol is on/flashing.

Water tank may be full. >>> Empty the water tank. Water discharge hose might have collapsed. >>> If the product is connected directly to the water drain check the water discharge hose.

The lighting inside the drying machine does not turn on. (In models with lamp)

The drying machine might not have been turned on using On/Off button. >>> Check that the drying machine is turned on.

Lamp might be malfunctioning. >>> Contact Authorized Service to replace the lamp.

Anti-crease icon is lit.

Anti-Crease mode that prevents the laundry in the drier to crease may be activated. >>> Turn the drier off and remove the laundry.

Fibre filter cleaning icon is lit.

Fibre filter (interior and exterior filter) may be unclean. >>> Wash the filters with warm water and dry..

A layer may be formed on the fibre filter pores that leads to clogging. >>> Wash the filters with warm water and dry. Fibre filters may not be inserted. >>> Insert the interior and exterior filters to their places.

An audible warning is heard from the machine

Fibre filters may not be inserted. >>> Insert the interior and exterior filters to their places.

Evaporator warning icon is flashing.

Evaporator front side may be clogged with fibres. >>> Clean the front side of the evaporator.

Fibre filters may not be inserted. >>> Insert the interior and exterior filters to their places.

The lighting inside the drying machine turns on. (In models with lamp)

If the drying machine is plugged to the power outlet, the On/Off button is pressed and the door is open; the light turns on. >>> Unplug the drying machine or bring the On/Off button to Off position.



WARNING!

- If the problem persists after following the instructions in this section, contact your vendor or an Authorized Service. Never try to repair your product yourself.



NOTE

- In an event that you encounter an issue on any part on your appliance, you can ask for a replacement by contacting the authorized service with the appliance model number.
- Operating the appliance with non-authentic parts may lead the appliance to malfunction.
- Manufacturer and distributor are not liable for malfunctions resulting from using non-authentic parts.

PRODUCT FICHE

Complying Commission Delegated Regulation (EU) No 392/2012

Supplier name or trademark		BEKO
Model name		DS8444RX 7188233810
Rated capacity (kg)		8,0
Type of Tumble Dryer	Air Vented	-
	Condenser	•
Energy efficiency class ⁽¹⁾		A++
Annual Energy Consumption (kWh) ⁽²⁾		234,7
Type of Control	Automatic	•
	Non-automatic	-
Energy consumption of the standard cotton programme at full load (kWh)		1,97
Energy consumption of the standard cotton programme at partial load (kWh)		1,08
Power consumption of the off-mode for the standart cotton programme at full load, P ₀ (W)		0,10
Power consumption of the left-on mode for the standart cotton programme at full load, P _L (W)		1,00
The duration of the left on mode (min)		30
Standard cotton programme ⁽³⁾		
Programme time of the standard cotton programme at full load, T _{dy} (min)		197
Programme time of the standard cotton programme at partial load, T _{dy1/2} (min)		125
Weighted programme time of the standard cotton programme at full and partial load (T _d)		156
Condensation efficiency class ⁽⁴⁾		B
Average condensation efficiency of the standard cotton programme at full load, C _{dry}		85%
Average condensation efficiency of the standard cotton programme at partial load, C _{dry1/2}		85%
Weighted condensation efficiency of the standard cotton programme at full load and partial load, C _t		85%
Sound power level for the standard cotton programme at full load ⁽⁵⁾		65
Built-in		-

• : Yes - : No

(1) Scale from A+++ (most efficient) to D (least efficient)

(2) Energy consumption based on 160 drying cycles of the standard cotton programme at full and partial load, and the consumption of the low-power modes. Actual energy consumption per cycle will depend on how the appliance is used.

(3) "Cotton cupboard dry programme" used at full and partial load is the standard drying programme to which the information in the label and the fiche relates, that this programme is suitable for drying normal wet cotton laundry and that it is the most efficient programme in terms of energy consumption for cotton

(4) Scale from G (lest efficient) to A (most efficient)

(5) Weighted average value — L_{WA} expressed in dB(A) re 1 pW

Vă rugăm să citiți mai întâi acest manual de utilizare!

Stimate client,

Vă mulțumim pentru alegerea produselor Beko. Sperăm că produsul nostru, fabricat la standarde de înaltă calitate și tehnologie, vă va oferi cele mai bune rezultate. Vă recomandăm să citiți cu atenție acest manual și alte documentații suplimentare înainte de a utiliza produsul dumneavoastră și să le păstrați pentru referințe ulterioare. Dacă oferiți acest produs altei persoane, oferiți-i și manualul aferent. Acordați atenție tuturor detaliilor și avertismentelor specificate în manualul de utilizare și respectați instrucțiunile prezentate în acesta.

Utilizați manualul de utilizare pentru modelul indicat pe copertă.



- Citiți instrucțiunile.

Explicația simbolurilor

Următoarele simboluri sunt utilizate în cuprinsul acestui manual de utilizare:



PERICOL!

- Avertisment împotriva electrocutării.



PERICOL!

- Avertisment împotriva pericolului de incendiu.



AVERTISMENT!

- Avertismente privind situații periculoase pentru viață și proprietate.



AVERTISMENT!

- Avertisment împotriva suprafețelor fierbinți.



AVERTISMENT!

- Avertizare privind riscul de arsuri



REȚINEȚI

- Informații importante sau sfaturi utile despre utilizare.



- Ambalajele produsului sunt fabricate din materiale reciclabile în conformitate cu Reglementările naționale privind mediul.

Nu eliminați deșeurile de ambalaje împreună cu deșeurile menajere sau alte deșeuri, eliminați-le la punctele de colectare speciale, desemnate de autoritățile locale.



1 Instrucțiuni importante de securitate și mediu



REȚINEȚI

- Această secțiune conține instrucțiuni de securitate care vă vor ajuta la protecția împotriva riscului de rănire sau deteriorarea a proprietății. Nerespectarea acestor instrucțiuni va anula orice garanție.

1.1 Informații generale privind securitatea



AVERTISMENT!

- Acest echipament poate fi utilizat de copii cu vârsta de peste 8 ani și persoane cu capacitate fizică, senzorială sau mentală redusă sau care nu au experiență și nu sunt familiarizate cu echipamentul dacă acestea sunt supravegheate sau li se oferă instrucțiuni privind utilizarea echipamentului într-o manieră sigură și înțeleg pericolele implicate. Copiii nu trebuie să se joace cu echipamentul. Curățarea și operațiunile de întreținere realizate de utilizator nu vor fi realizate de copii nesupravegheați.
- Nu permiteți copiilor cu vârsta sub 3 ani accesul la aparat cu excepția cazului în care sunt în permanent supravegheați.
- Picioarele reglabile nu trebuie îndepărtate. Spațiul liber dintre uscător și podea nu trebuie redus cu materiale precum covoare, lemn sau bandă. Acest lucru cauzează probleme în funcționarea uscătorului.



AVERTISMENT!

- Instalarea și procedurile de reparare trebuie efectuate întotdeauna de către Personalul autorizat de service. Producătorul nu va fi răspunzător pentru daunele care pot apărea din efectuarea procedurilor de către persoane neautorizate.
- Nu spălați niciodată uscătorul prin pulverizarea sau picurarea apei pe echipament! Există pericol de electrocutare!

1.1.1 Securitatea electrică



PERICOL!

- **Securitatea electrică**
Instrucțiunile privind securitatea electrică trebuie respectate în timpul efectuării racordării la rețeaua electrică în momentul instalării.
- **Aparatul nu trebuie alimentat printr-un dispozitiv de conectare, cum ar fi un comutator temporizat, sau conectat la un circuit care este activat sau dezactivat regulat de serviciul public utilitar.**
- Conectați uscătorul la o priză cu împământare protejată de o siguranță la valoarea specificată pe etichetă. Instalarea împământării trebuie efectuată de către un electrician calificat. Societatea noastră nu va fi răspunzătoare pentru nicio daună care poate apărea în momentul în care uscătorul este utilizat fără împământare, în conformitate cu regulamentele locale.



PERICOL!

- Tensiunea și protecția permisă a siguranței sunt specificate pe etichetă.
- Tensiunea specificată pe etichetă trebuie să fie egală cu tensiunea sursei dumneavoastră principale de alimentare. Scoateți uscătorul din priză când nu îl utilizați.
- Deconectați uscătorul de la sursa principală de alimentare în timpul instalării, operațiunilor de întreținere, curățare și reparație.
- Nu atingeți priza dacă aveți mâinile umede! Nu deconectați niciodată aparatul prin smulgerea cablului, întotdeauna prindeți de fișă atunci când scoateți cablul.
- Nu utilizați prelungitoare, blocuri multipriză sau adaptoare pentru conectarea uscătorului la sursa de alimentare, pentru a permite scăderea riscului de incendiu sau de electrocutare.
- Fișa cablului de alimentare trebuie să fie ușor accesibilă după instalare.
- **Cablul principal deteriorat trebuie înlocuit, notificând Personalul autorizat de service.**
- **Dacă uscătorul este defect, acesta nu trebuie utilizat decât dacă a fost reparat de către un agent autorizat de service!**
- **Există pericol de electrocutare!**

1.1.2 Securitatea produsului



AVERTISMENT!

- Asigurați-vă că admisia de aer a uscătorului este deschisă și bine ventilată.
- Produsul conține agent frigorific R290.
- Produsul conține agent frigorific R290.
- Țineți produsul departe de posibile surse de căldură care pot provoca aprinderea.



PERICOL!

- **Puncte de luat în considerare în cazul pericolului de incendiu:**

Următoarele tipuri de rufe sau articole nu trebuie uscate în uscător, având în vedere pericolul de incendiu.

- Rufe nespălate
- Articolele pătate cu ulei, acetonă, alcool, păcură, cherosen, soluții de îndepărtare a petelor, terebentină, parafină sau soluții de îndepărtare a parafinei, trebuie spălate în apă caldă cu mult detergent înainte de a fi uscate în uscător.

Din acest motiv, în special articolele care prezintă petele specificate anterior trebuie spălate foarte bine, iar pentru acest lucru trebuie să utilizați detergentul adecvat și să selectați o temperatură ridicată de spălare.

- **Următoarele rufe sau articole specificate nu trebuie uscate în uscător din cauza pericolului de incendiu:**



PERICOL!

- Articole de îmbrăcăminte sau perne întărite cu spumă de cauciuc (spumă latex), bonete de duș, materiale textile rezistente la apă, materiale cu întăritură din cauciuc și pernțe din spumă de cauciuc.
- Articole de îmbrăcăminte curățate cu substanțe chimice industriale.
- Articole precum brichete, chibrite, monede, piese din metal, ace, etc. pot deteriora ansamblul tamburului sau pot duce la probleme de funcționare. De aceea, verificați toate rufele spălate pe care le încărcăți în uscătorul dumneavoastră.
- Nu opriți niciodată uscătorul înainte de finalizarea programului. Dacă trebuie să faceți acest lucru, îndepărtați rapid toate rufele spălate și întindeți-le pentru a elimina căldura.
- Articolele de îmbrăcăminte care au fost spălate neadecvat se pot autoaprinde, chiar și după finalizarea procesului de uscare.
- Trebuie să furnizați o ventilație suficientă pentru a preveni acumularea în cameră a gazelor emise de dispozitivele care funcționează cu alte tipuri de combustibil, inclusiv flacăra deschisă, din cauza efectului de aprindere inversă.



AVERTISMENT!

- Lenjeria care conține întărituri din metal nu trebuie uscată în uscător. Uscătorul se poate deteriora dacă întăriturile din metal se slăbesc și se rup în timpul procesului de uscare.



REȚINEȚI

- Utilizați balsamuri de rufe și produse similare în conformitate cu instrucțiunile producătorilor acestora.
- Întotdeauna curățați filtrul de scame înainte sau după fiecare încărcare. Nu operați niciodată uscătorul fără a avea filtrul de scame instalat.



AVERTISMENT!

- Nu încercați niciodată să reparați dumneavoastră uscătorul. Nu efectuați nicio reparație sau procedură de înlocuire pe produs chiar dacă știți sau aveți capacitatea de a efectua procedurile necesare, doar dacă se specifică clar acest lucru în instrucțiunile de funcționare sau în manualul de service publicat. Altfel, vă puneți viața dumneavoastră și a celorlalți în pericol.
- Nu trebuie să existe nicio ușă blocabilă, culisantă sau batantă care ar putea bloca deschiderea ușii de încărcare în locația în care uscătorul dumneavoastră va fi instalat.
- Instalați uscătorul dumneavoastră în locații adecvate pentru utilizare casnică. (Baie, balcon închis, garaj, etc.)



AVERTISMENT!

- Asigurați-vă că animalele de casă nu intră în uscător. Verificați interiorul uscătorului înainte de a-l porni.
- Nu vă aplecați pe ușa de încărcare a uscătorului dumneavoastră atunci când este deschisă; aceasta ar putea cădea.
- Nu se va permite acumularea scamelor în jurul uscătorului.

1.2 Montajul pe o mașină de spălat

- Se va utiliza un dispozitiv de fixare între cele două mașini în momentul instalării uscătorului peste o mașină de spălat. Dispozitivul de fixare trebuie instalat de către un agent autorizat de service.
- Greutatea totală a mașinii de spălat și a uscătorului - în sarcină completă - în locația în care sunt montate una peste alta trebuie să atingă aproximativ 180 de kilograme. Așezați produsele pe o suprafață solidă care are o capacitate suficientă de susținere a sarcinii!



AVERTISMENT!

- Mașina de spălat nu poate fi așezată pe uscător. Acordați atenție avertismentelor anterioare în timpul instalării pe mașina dumneavoastră de spălat.

Masa de instalare pentru mașina de spălat și uscător

Adâncimea uscătorului	Adâncimea mașinii de spălat			
	62 cm	60 cm	54 cm	< 50 cm
54 cm	Poate fi instalat.		Nu poate fi instalat.	
60 cm	Poate fi instalat.	Nu poate fi instalat.		

1.3 Domeniul de utilizare

- Uscătorul este conceput pentru utilizare casnică. Nu este adecvat pentru utilizare comercială și nu trebuie utilizat în alte scopuri decât utilizarea recomandată.
- Utilizați uscătorul doar pentru uscarea rufelor marcate special în acest sens.
- Producătorul nu își asumă nicio răspundere care poate apărea din utilizarea sau transportul incorect.
- Durata de funcționare a uscătorului pe care l-ați achiziționat este de 10 ani. În timpul acestei perioade, piesele de schimb originale vor fi disponibile pentru funcționarea adecvată a uscătorului.

1.4 Siguranța copiilor

- Ambalajele sunt periculoase pentru copii. Nu lăsați ambalajele la îndemâna copiilor. Produsele electrice sunt periculoase pentru copii. Nu lăsați copii în apropierea produsului care este în funcțiune. Nu permiteți copiilor să umble la uscător. Utilizați un sistem de închidere securizat pentru copii pentru a-i împiedica să umble la uscător.



REȚINEȚI

- Sistemul de închidere securizat pentru copii se află pe panoul de control. (Consultați secțiunea Sistem de închidere securizat pentru copii)
- Mențineți ușa de încărcare închisă chiar și atunci când uscătorul nu este în funcțiune.

1.5 Conformitate cu Directiva WEEE și depozitarea la deșeuri a produsului uzat:



Acest produs respectă Directiva UE WEEE (2012/19/UE). Produsul este marcat cu un simbol de clasificare pentru deșeuri electrice și electronice (WEEE).

Acest produs a fost fabricat folosind piese și materiale de înaltă calitate, care pot fi refolosite și reciclate. Nu depozitați produsul uzat împreună cu gunoiul menajer la sfârșitul duratei sale de funcționare. Duceți-l la un centru de colectare pentru reciclarea echipamentelor electrice și electronice. Luați legătura cu autoritățile locale pentru a afla informații despre aceste centre de colectare.



PERICOL!

- R290 este un agent frigorific inflamabil. Astfel, asigurați-vă că sistemul și țevile nu sunt avariate în timpul operării și manevrării.
- Țineți produsul departe de posibile surse de căldură care pot provoca aprinderea în caz de avarii.
- Nu casați produsul dându-i foc.

1.6 Conformitate cu Directiva RoHS:

Produsul pe care l-ați achiziționat respectă Directiva UE RoHS (2011/65/UE). Nu conține materiale dăunătoare și interzise specificate în Directivă.

1.7 Informații despre ambalaj

Ambalajul produsului este produs din materiale reciclabile, conform reglementărilor noastre naționale de mediu. Nu depozitați ambalajul împreună cu gunoiul menajer sau cu alte deșeuri. Depozitați-l în punctele de colectare a ambalajelor amenajate de autoritățile locale.

1.8 Specificații tehnice

RO

Înălțime (Min. / Max.)	84,6 cm / 86,6 cm*
Lățime	59,7 cm
Adâncime	58,9 cm
Capacitate (max.)	8 kg**
Greutate netă (± 4 kg)	44 kg
Tensiune	Consultați eticheta***.
Putere nominală de intrare	
Cod model	

* Înălțime min.: Înălțimea cu picioarele reglabile închise.

Înălțime max.: Înălțimea cu picioarele reglabile deschise la nivelul maxim.

**Greutatea rufelor uscate înainte de spălare.

*** Eticheta cu tipul aparatului se află în spatele ușii de încărcare.



REȚINEȚI

- Specificațiile tehnice ale uscătorului sunt supuse modificărilor fără o notificare prealabilă pentru a îmbunătăți calitatea produsului.
- Imaginile din acest manual de utilizare sunt schematic și pot să nu corespundă exact produsului dumneavoastră.
- Valorile specificate pe marcajele de pe uscător sau din alte documentații publicate care însoțesc uscătorul sunt obținute în laborator în conformitate cu standardele relevante. Aceste valori pot varia în funcție de condițiile de operare și de mediu ale uscătorului.

2 Uscătorul dumneavoastră

2.1 Prezentare generală

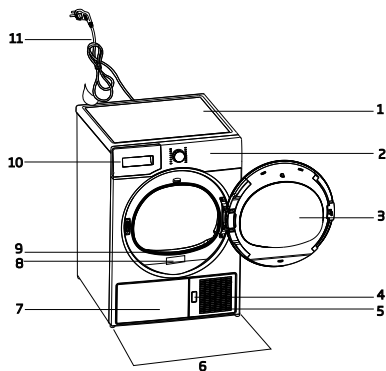

1. Panoul superior
2. Panoul de comandă
3. Ușa de încărcare
4. Butonul de deschidere a plăcii de protecție
5. Grătare de ventilare
6. Picioare reglabile
7. Placa de protecție
8. Eticheta
9. Filtru de scame
10. Sertarul rezervorului de apă
11. Cablul de alimentare

2.2 Conținutul ambalajului

	1. Furtun pentru scurgerea apei*		5. Manual de utilizare al tamburului de uscare*
	2. Burete de schimb pentru sertarul filtrului*		6. Recipientul de umplere cu apă*
	3. Manual de utilizare		7. Apă pură*
	4. Tambur de uscare*		8. Unitatea pentru pastile de parfum*

*Poate fi furnizată împreună cu mașina dumneavoastră în funcție de modelul acesteia.

3 Instalare

Înainte de a telefona celui mai apropiat Centru de service pentru instalarea uscătorului, asigurați-vă că instalația electrică și rețeaua de scurgere a apei sunt corespunzătoare conform manualului de utilizare. Dacă acestea nu sunt adecvate, contactați un electrician și un tehnician calificați pentru a realiza modificările necesare.



REȚINEȚI

- Clientul este răspunzător pentru pregătirea locației uscătorului, precum și pentru instalațiile electrice și de scurgere a apei menajere.



AVERTISMENT!

- Înainte de instalare, verificați vizual dacă uscătorul are defecte. Dacă uscătorul este deteriorat, acesta nu trebuie instalat. Produsele deteriorate cauzează riscuri asupra securității dumneavoastră.
- Așteptați 12 ore înainte de a porni uscătorul pentru utilizare.

3.1 Locația potrivită pentru instalare

Instalați uscătorul pe o suprafață stabilă și plană.

Uscătorul este greu. Nu mutați uscătorul singuri.

- Utilizați uscătorul într-un mediu bine ventilat și fără praf.
- Spațiul liber dintre uscător și podea nu trebuie redus cu materiale precum covoare, lemn sau bandă.
- Nu acoperiți grătarele de ventilare ale uscătorului.
- Nu trebuie să existe nicio ușă blocabilă, culisantă sau batantă care ar putea bloca deschiderea ușii de încărcare în locația în care uscătorul dumneavoastră va fi instalat.
- După instalarea uscătorului, acesta trebuie să rămână în același loc în care s-au realizat racordurile. La instalarea uscătorului, asigurați-vă că peretele din spate al acestuia nu atinge nimic (robinet, priză, etc.).

- Așezați uscătorul la cel puțin 1 cm de marginile altor corpuri de mobilier.
- Uscătorul dumneavoastră poate funcționa la temperaturi între +5°C și +35°C. În cazul în care condițiile de funcționare nu sunt cuprinse în acest interval, funcționarea uscătorului poate fi afectată și acesta se poate deteriora.
- Suprafața din spate a uscătorului va fi așezată pe un perete.



PERICOL!

- Nu așezați uscătorul pe cablul de alimentare.

*** Ignorați următorul avertisment dacă sistemul produsului dvs. nu conține R290**



PERICOL!

- Uscătorul conține agent frigorific R290.*
- R290 este un agent frigorific prietenos cu mediul, dar inflamabil.*
- Asigurați-vă că admisia de aer a uscătorului este deschisă și bine ventilată.*
- Asigurați-vă că admisia de aer a uscătorului este deschisă și bine ventilată.*

3.2 Îndepărtarea ansamblului de securitate în transport



AVERTISMENT!

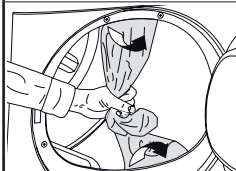

Îndepărtați ansamblul de securitate în transport înainte de a utiliza uscătorul pentru prima dată.

3.3 Racordarea la rețeaua de scurgere

Puteți scurge apa acumulată direct prin furtunul de scurgere a apei furnizat cu produsul, în locul scurgerii periodice a apei colectate în rezervor.

Racordarea furtunului de scurgere a apei

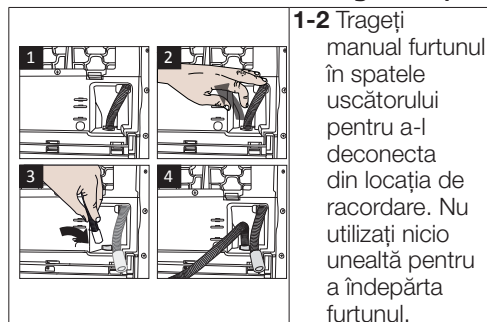

1-2 Trageți manual furtunul în spatele uscătorului pentru a-l deconecta din locația de racordare. Nu utilizați nicio unealtă pentru a îndepărta furtunul.

3 Conectați un capăt al furtunului de scurgere furnizat cu uscătorul la punctul de racordare de unde ați îndepărtat furtunul produsului în pasul anterior.

4 Conectați capătul celălalt al furtunului de scurgere direct la rețeaua de scurgere a apei menajere sau la chiuvetă.



REȚINEȚI

- Furtunul de scurgere a apei trebuie atașat la o înălțime de maxim 80 cm.
- Asigurați-vă că furtunul de scurgere a apei nu este călcat și nu are pliuri între rețeaua de scurgere și mașină.
- Dacă împreună cu produsul vi s-a furnizat și un pachet cu accesorii, vă rugăm să citiți descrierea detaliată.

3.4 Reglarea picioarelor

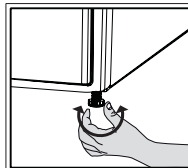

- Rotiți picioarele către stânga sau dreapta până ce uscătorul este așezat la nivel și fix.

3.5 Transportul uscătorului

Scoateți uscătorul din priză înainte de a-l transporta.

Surgeți toată apa care a rămas în uscător. Dacă s-a realizat o racordare directă la rețeaua de scurgere a apei, atunci îndepărtați racordurile furtunului



AVERTISMENT!

- Recomandăm să transportați uscătorul în poziție dreaptă. Dacă nu este posibil acest lucru, vă recomandăm transportul acestuia prin înclinarea mașinii către partea dreaptă, privind mașina din față.

3.6 Avertismente privind sunetele



REȚINEȚI

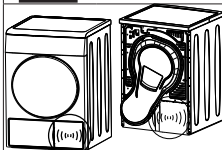

- Este normal să auziți un zgomot metalic din compresor în timpul funcționării.
- Apa colectată în timpul funcționării este pompată către rezervorul de apă. Este normal să auziți zgomotul de pompare în timpul procesului.

3.7 Înlocuirea lămpii de iluminare

În cazul utilizării unei lămpi de iluminare în uscătorul dumneavoastră
Pentru a înlocui becul/LED-ul utilizat pentru iluminare în uscătorul dumneavoastră, apălați la Centrul autorizat de service local.
Lampa (lămpile) utilizate în acest aparat nu este (sunt) corespunzătoare pentru iluminarea unei camere. Scopul recomandat al acestei lămpi este de a asista utilizatorul în așezarea rufelor în uscător într-un mod confortabil. "Becurile folosite în acest aparat trebuie să reziste la condiții fizice extreme precum vibrațiile și temperaturile de peste 50 °C."

4 Pregătirea

4.1 Rufe corespunzătoare pentru uscarea în uscător

Urmați întotdeauna instrucțiunile oferite pe etichetele vestimentare. Uscăți la uscător doar rufe care au o etichetă care le indică ca fiind potrivite pentru uscare în uscător.

4.2 Rufe necorespunzătoare pentru uscarea în uscător



Articolele cu acest simbol nu trebuie uscate în Uscător.



REȚINEȚI

- Materialele brodate delicate, lâna, articolele din mătase, materialele delicate și fine, articolele ermetice și perdelele din tul nu sunt corespunzătoare pentru uscător.

4.3 Pregătirea rufelor pentru uscare

- Rufe pot fi încălcite după spălare. Separați articolele înainte de a le așeza în uscător.
- Uscăți articolele care au accesorii din metal, precum fermoare, pe dos.
- Închideți fermoarele, cărligele și cataramele și butonii.

4.4 Modalități de reducere a consumului de energie electrică

- Informațiile următoare vă vor ajuta să utilizați uscătorul într-o manieră ecologică și eficientă din punct de vedere al energiei electrice.
- Stoarceți rufe la viteza cea mai mare posibilă în momentul în care le spălați. Astfel, timpul de uscare este redus, iar consumul de energie electrică este redus.
- Sortați rufe în funcție de tipul și grosimea acestora. Uscăți același tip de rufe împreună. De exemplu, prosoapele de bucătărie subțiri și fețele de masă se usucă mai rapid decât prosoapele de baie.
- Urmați instrucțiunile din manualul de utilizare pentru selectarea programelor.
- Nu deschideți ușa de încărcare a mașinii în timpul procesului de uscare decât dacă este necesar. Dacă trebuie neapărat

să deschideți ușa de încărcare, nu o mențineți deschisă timp îndelungat.

- Pentru modelele cu condensator: curățați condensatorul o dată pe lună sau tot la 30 de cicluri de funcționare.
- Pentru modelele cu pompă de căldură: curățați sertarul filtrului periodic când există o acumulare vizibilă de puf sau când indicatorul de curățare al sertarului filtrului se iluminează.
- Pentru modelele cu coș de fum: respectați instrucțiunile pentru coșul de fum și curățați-l.
- În timpul ciclului de uscare, aerisiți bine încăperea unde este amplasat uscătorul dvs. de rufe.

4.5 Sarcina corectă

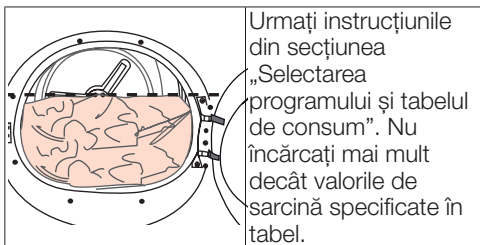

Următoarele valori de greutate sunt oferite drept exemplu.

Rufe	Approximate weights (g)*	Rufe	Approximate
Cuverturi din bumbac (duble)	1500	Bluze	150
Cuverturi din bumbac (simple)	1000	Cămăși din bumbac	300
Așternuturi (duble)	500	Cămăși	250
Așternuturi (simple)	350	Rochii din bumbac	500
Fețe de masă mari	700	Rochii	350
Fețe de masă mici	250	Blugi	700
Șervețele	100	Batiste (10 bucăți)	100
Prosoape de baie	700	Tricouri	125
Prosoape de mână	350		

*Greutatea rufelor uscate înainte de spălare.

5 Operarea produsului

5.1. Panoul de comandă

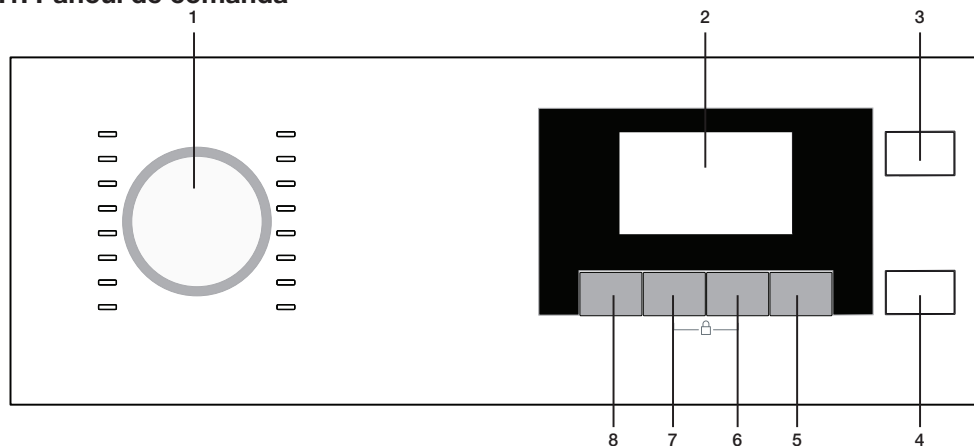

1. Buton selectare programe
2. Afişaj
3. Buton On/Off (Pornire/Oprire)
4. Buton Start/Stand-by (Pornire/Pauză)

5. Buton End Time (Sfârşitul programului)
6. Buton de reglare a perioadei programelor/
7. Buton nivel alarmă audio
8. Buton selecție setări nivel uscare

5.2 Simboluri ecran

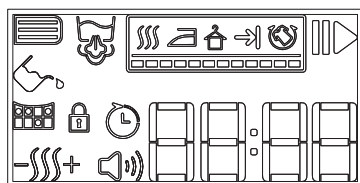
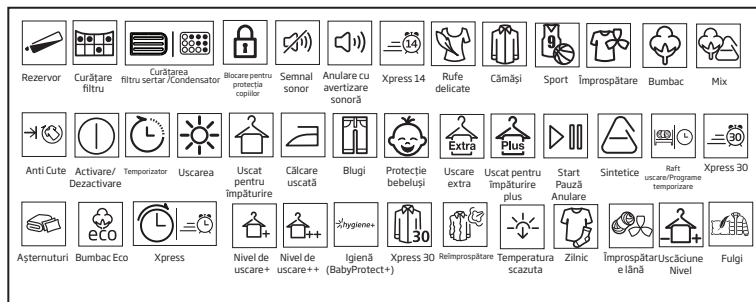

- Simbol nivel alarmă
- Uscare pentru împăturire
- Simbol avertizare curățare sarter filtru
- Simbol avertizare curățare filtru
- Simbol avertizare blocare pentru protecția copiilor
- Term în are ciclu
- Simbol abur
- Anti Cute
- Simbol program cu abur
- Timp finalizare
- Nivel uscare
- Indicator durată rămasă*
- Călcare uscată

* Timpul afișat indică timpul rămas pentru terminarea ciclului și acest timp vaiază în funcție de umezeala rufelor.

5.3 Pregătirea uscătorului

Introduceți uscătorul în priză
Deschideți ușa dispozitivului.
Așezați rufele în cuvă desfăcute.
Închideți ușa prin împingere.

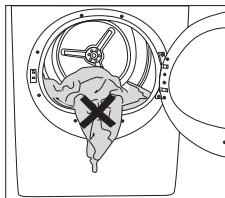

NOTĂ

- Asigurați-vă că nu se află niciun obiect între ușă și dispozitiv atunci când o închideți.

Apăsați și țineți apăsat butonul On/Off/Cancel (Pornire/Oprire/Anulare) timp de o secundă.

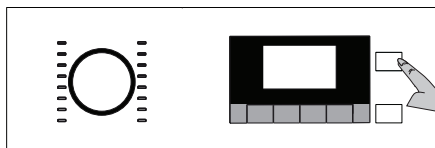

- Când uscătorul este folosit pentru prima oară, este selectat programul demonstrativ (bumbac, uscare pentru împăturire).



NOTĂ

- Programul nu începe imediat doar prin apăsarea butonului **On/Off/Cancel (Pornire/oprire/Anulare)**. Începeți programul cu butonul **On/Off/Cancel (Pornire/oprire/Anulare)** după selectarea programului.

5.4 Selectare program

Uscătorul dvs. are 16 programe diferite.

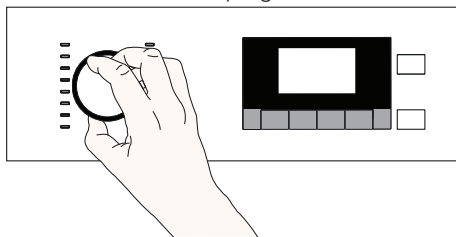

- Selectați programul dorit rotind butonul de selectare a programului.
- Tabelul afișat cu selectarea și consumul programului sunt bazate pe sortarea după preferințele majorității utilizatorilor.

5.5 Tabel selectare programe și consum

RO				
Programe	Descriere program	Capacitate (kg)	Viteza de stoarcere în mașina de spălat (rpm)	Țimp de uscare (minute)
Uscare bumbac pentru călcare	Puteți usca rufele din bumbac pentru călcare în acest program pentru a fi ușor umede, gata de călcare. (cămașă, tricou, față de masă etc.)	8	1000	145
Bumbac Eco	Puteți usca toate rufele dvs. din bumbac în acest program. (tricouri, pantaloni, pijamale, haine de bebeluși, lenjerie intimă, pânză etc.) Puteți pune rufele în dulap fără călcare.	8	1000	197
Uscare bumbac pentru împăturire	Puteți folosi acest program pentru o uscare superioară a rufelor groase cum ar fi pantaloni, treninguri. Puteți să vă puneți rufele în șifonier fără a le călca.	8	1000	205
Uscare extra bumbac	Puteți usca rufele din bumbac gros în acest program precum prosoapele, halatele etc. Puteți pune rufele în dulap fără călcare.	8	1000	210
Uscare sintetice pentru călcare	Puteți usca rufele din materiale sintetice pentru călcare în acest program pentru a fi ușor umede, gata de călcare. (cămașă, tricou, față de masă etc.)	4	800	60
Uscare sintetice pentru împăturire	Puteți usca toate rufele dvs. din materiale sintetice în acest program. (cămașă, tricou, pantaloni, lenjerie intimă, fațade masă etc.) Puteți pune rufele în dulap fără călcare.	4	800	70
Raft uscare/ Program uscare	Puteți selecta programele de timp între 10 și 160 de minute, pentru a atinge la temperaturi scăzute nivelul de uscare dorit. În cadrul acestui program, funcționarea uscătorului cu tambur se întinde pe durata setată independent de nivelul de uscare a rufelor. Acest produs este disponibil pentru a fi utilizat cu un coș de uscare ca și opțiune. Pentru produsele solide fără coș, puteți obține un coș de la un serviciu autorizat și folosi programele de uscare menționate mai sus. Pentru detalii de utilizare, vedeți ghidul pentru utilizare al coșului de uscare.	-	-	-
Refresh (Wool Refresh)	Se ventilează preț de 10 minute fără a sufla aer cald. Puteți ventila bumbacul și hainele de pânză care au fost închise o vreme îndelungată cu acest program pentru a îndepărta mirosul. Puteți folosi acest program pentru a ventila și înmuia lâna lrufelor din lână care pot fi spălate într-o mașină de spălat. Nu folosiți pentru uscare completă.	-	-	10
Rufe delicate	Puteți usca rufele delicate sau rufele obișnuite cu simbolul de spălare manuală (bluze de mătase, lenjerie intimă subțire etc.) la o temperatură scăzută în acest program.	1,5	1200	70

Blugi	Puteți usca pantalonii, rochiile, cămășile sau hainele din denim în acest program.	4	1200	150
Exterior/Sporturi (Goretex)	Folosiți-l pentru a usca hainele făcute din sintetice, bumbac sau materiale amestecate sau produse rezistente la apă precum jachetele funcționale, pelerine etc. Întoarceți-le pe dos înainte de uscare.	2	1000	135
Mix(Zilnic)	Puteți usca cu acest program atât rufe din bumbac, cât și sintetice. Hainele de sport și fitness pot fi uscate cu acest program.	4	1000	125
Îngrijire delicată/ Cămăși	Uscă cămășile într-un mod mai delicat și nu șifonează foarte mult, necesitând mai puțină călcare	1,5	1200	60
Igienă (BabyProtect+)	E un program pe termen lung pe care îl puteți folosi pentru haine (haine de copii, prosoape, lenjerie intimă, etc.) care necesită igienă specială. Igiena e oferită prin temperatura mare ((Acest program este identificat și aprobat de "The British Foundation" din Anglia (Allergy UK).))	5	800	185
Așternuturi/Fulgi	Puteți usca textilele umplute cu pene sau cu fibre care pot fi uscate în uscător ca o singură rufă. Puteți usca o pătură mare, perne sau haine ca o singură rufă. Uscăți hainele precum sacouri și jachete întoarse pe dos.	-	800	165
Xpress 30	Folosiți acest program pentru a avea 2 cămăși gata de călcat	0,5	1200	30

Valori ale consumului de energie

Programe	Capacitate (kg)	Viteza de stocare în mașina de spălat (rpm)	Cantitatea aproximativă de umezeală rămasă	Valoarea consumului de energie kWh
Bumbac Eco*	8	1000	60%	1,97
Uscare bumbac pentru călcare	8	1000	60%	1,5
Uscare sintetice pentru împăturire	4	800	40%	0,75
	"Programul de uscare bumbac Eco" folosit la capacitate maximă și parțială este programul de uscare standard la care se referă informațiile de pe etichetă și din fișa tehnică, adică acest program este adecvat pentru uscarea lenjeriei de bumbac normală udă și că este cel mai eficient program în termeni de consum de energie pentru bumbac.			

* : Cadru privind directiva de etichetare energetică (EN 61121:2012)

Toate valorile din tabel sunt determinate în funcție de directiva EN 61121:2012. Valorile de consum pot varia în tabel în funcție de tipul de rufe, viteza de rotație, condițiile ambientale și schimbările în tensiune.



NOTĂ

- Când se termină programul antișifonare pentru rufe delicate, scoateți rufele imediat și întindeți-le.
- Pentru a obține rezultate mai bune de la programele de uscare ale mașinii, rufele trebuie spălate cu programul adecvat în mașina de spălat și stoarse cu numărul de rotații corespunzător.
- Cămașa poate rămâne ușor umedă la finalul programului. Este recomandat să nu lăsați aceste cămăși în uscător.



Nivelul volumului scăzut

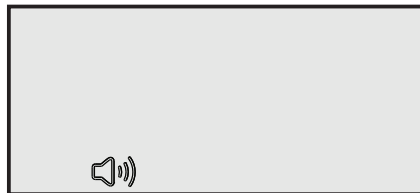

Nivelul volumului ridicat



Allergy UK reprezintă o marcă a British Allergy Association. Marca de aprobare este creată pentru a ajuta persoanele care au nevoie de recomandări pentru un produs, care să

confirme faptul că produsul respectiv restricționează/reduce/elimină alergenii sau reduce semnificativ conținutul de alergeni din ambient, pentru pacienții cu alergii. Aceasta are ca scop să furnizeze asigurări cu privire la faptul că produsele sunt testate științific sau sunt examinate astfel încât să furnizeze rezultate concrete.

5.6 Funcții auxiliare

Avertizare sonoră

Mașina emite un avertisment sonor atunci când programul este terminat. Pentru a ajusta nivelul de sunet, folosiți butonul Nivel avertizare sonoră.



NOTĂ

- Puteți schimba nivelul de sunet înainte începerii programului sau în timp ce programul continuă.



NOTE

- Puteți activa această funcție doar înainte de începerea programului.

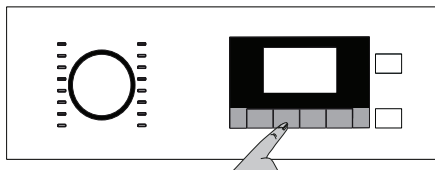
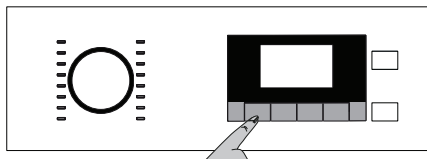



Nivel de uscare umed



Nivel de uscare normal

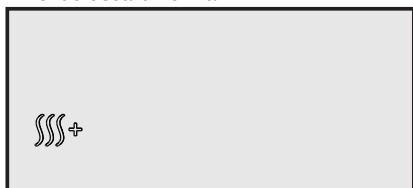

Nivel de uscare suplimentar

5.7 Simboluri de avertizare

NOTĂ

- Simbolurile de avertizare pot varia în funcție de specificațiile modelului mașinii dvs.

Curățarea filtrului de fibre

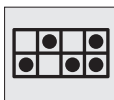

Atunci când programul este terminat, simbolul de avertizare pentru curățarea filtrului se aprinde.

NOTĂ

- Pentru informații detaliate, consultați 6 Întreținere și curățare.
- Dacă simbolul de curățare a filtrului clipește încontinuu consultați .7 Depanare.

Golirea rezervorului de apă

Atunci când programul este terminat, simbolul de avertizare pentru golirea rezervorului se aprinde.

NOTĂ

- Pentru informații detaliate, consultați 6 Întreținere și curățare.

Dacă rezervorul de apă se umple în timp ce programul funcționează, simbolul de avertizare începe să clipească și mașina intră în stand-by. În acest caz, goliți apa din rezervor și porniți programul apăsând butonul Start / Pause (Start/Pauză). Simbolul de avertizare se stinge și programul e reluat.



Curățarea sertarului filtrului

Simbolul de avertizare clipește periodic pentru a vă reaminti că filtrul trebuie curățat.

NOTĂ

- Pentru informații detaliate, consultați 6 Întreținere și curățare.



Capacul de încărcare este deschis

În cazul în care capacul de încărcare al uscătorului este deschis în timpul uscării, simbolul de stand-by se aprinde și desfășurarea programului se aprinde intermitent.

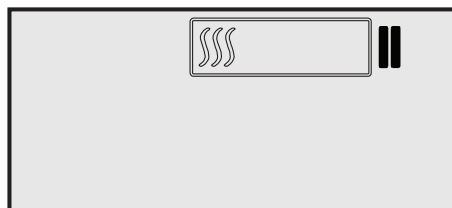

Tim finalizare

Puteți prelungi durata programului cu până la 24 de ore cu funcția încheiere durată.

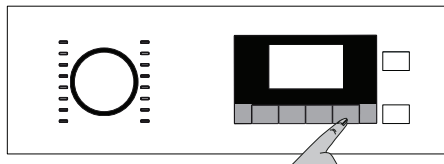

- Deschideți ușa de încărcare și plasați rufe acolo.
- Selectați programul de uscare, ciclul de centrifugare și, dacă e nevoie, funcții suplimentare.
- Apăsați butonul de selectare a timpului finalizare și setați durata dorită. Simbolul de timp finalizare se aprinde. (Când este apăsat și ținut apăsat butonul, durata continuă non-stop).
- Apăsați butonul Start / Stand-by (Start/Pauză). Numărătoarea inversă până la timpul de finalizare începe și simbolul Start se aprinde. “:” Separatorul din mijlocul intervalului de temporizare afișat clipește.

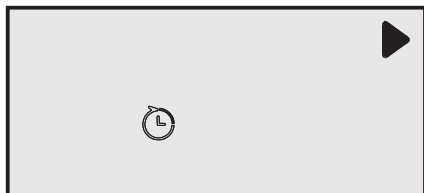

NOTĂ

- Puteți adăuga sau îndepărta rufe în intervalul de finalizare. Simbolul Timp finalizare se va opri la finalul număratorilor inverse, uscarea începe și durata programului este afișată. Timpul afișat este suma dintre timpul normal de uscare și timpul de finalizare.

Schimbarea timpului de finalizare

Dacă doriți să schimbați durata în timpul numărătorii inverse:

- Apăsați butonul On/Off/Cancel timp de 3 secunde pentru a anula programul. Porniți din nou mașina și repetați procesul Delay Setting (Setare întârziere) pentru durata dorită.
- Atunci când mașina dvs. e pornită pentru prima oară, pornește cu programul demonstrativ (bumbac, uscarea pentru împăturire).

Anularea funcției de timp finalizare

Dacă doriți să anulați numărătoarea inversă a timpului finalizare și să începeți programul imediat:

- Apăsați butonul On/Off/Cancel preț de 3 secunde pentru a anula programul.
- Apăsați butonul On/Off/Cancel pentru a începe programul selectat anterior.

5.8 Pornirea programului

Apăsați ► butonul Start/Pause (Start/Pauză) pentru a începe programul. Indicând începutul programului, simbolul Start se aprinde, “:” separatorul din mijlocul timpului rămas clipește. Simbolul de desfășurare program se aprinde.

5.9 Stare desfășurare program

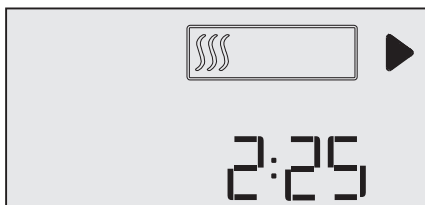

5.10 Blocare pentru protecția copiilor

Mașina are o funcție pentru siguranța copiilor care face ca fluxul programului mașinii să nu fie afectat dacă sunt apăstate butoanele în timpul unui program. Pentru a activa funcția de blocare pentru protecția copiilor.

- Apăsați și mențineți apăsat butoanele de temporizare și de avertizare sonoră preț de 3 secunde.
- Atunci când blocarea pentru protecția copiilor este activată, simbolul de blocare de pe ecran se aprinde.

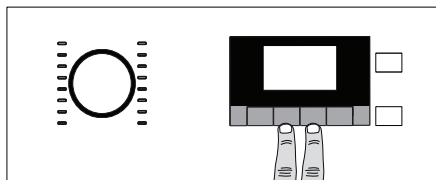

- Atunci când funcția de blocare pentru protecția copiilor este activată, toate butoanele de pe panou, cu excepția butonului On/Off/Cancel și Child Lock sunt dezactivate.
- Când blocarea pentru protecția copiilor este activată, simbolurile indicatoarelor nu se schimbă, dacă poziția butonului Selecție Program este schimbată. Atunci când butonul Selecție Program este rotit și butoanele funcționale sunt apăstate, literele "CL" clipească pe ecran.

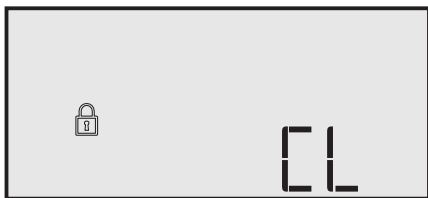

- Blocarea pentru protecția copiilor trebuie dezactivată pentru a putea porni un nou program după ce se termină programul curent sau pentru a putea afecta programul curent.

Pentru a dezactiva funcția de blocare pentru protecția copiilor:

- Mențineți apăsat butonul timp de 3 secunde.
- Blocarea pentru protecția copiilor se dezactivează atunci când uscătorul este oprit și repornit folosind butonul **On/Off/Cancel (Pornire/Oprire/Anulare)**.

5.11 Schimbarea programului după pornire

Puteți schimba programul selectat pentru a usca rufe dvs. cu un program diferit după ce mașina începe să meargă.

- De exemplu, pentru a selecta programul Extra Dry (uscare extra) în loc de Iron Dry (Uscare pentru călcat), opriți programul apăsând butonul Start / Stand-by (Start/Pauză).
- Selectați programul Extra Dry (uscare extra) folosind butonul Program Selection (Selectare program).
- Apăsați butonul Start/Stand-by (Start/Pauză) pentru a începe programul.

Adăugarea și scoaterea hainelor în modul stand-by

- Dacă doriți să adăugați sau să scoateți haine din mașină după începerea programului de uscare:
- Apăsați butonul Start/Stand-by (Start/Pauză) pentru a pune mașina în modul Stand-by. Operațiunea de uscare se oprește.
- Deschideți ușa de încărcare în poziția Stand-by (Pauză) și închideți ușa după ce ați adăugat sau scos rufe.
- Apăsați butonul Start/Stand-by (Start/Pauză) pentru a începe programul.



NOTĂ

- Adăugarea de rufe după ce operațiunea de uscare a început poate face ca rufe uscate din interiorul mașinii să se amestece cu rufele ude și să rămână umede după terminarea operațiunii.
- Adăugarea sau îndepărtarea rufelor poate fi repetată de câte ori doriți. Dar această operațiune întrerupe în mod constant operațiunea de uscare și ar face ca durata programului să se prelungească și să mărească consumul de energie. Astfel, este recomandat să adăugați rufe înainte de începerea programului.
- Dacă un nou program este selectat rotind butonul de selecție în timp ce mașina este în stand-by; programul de rulare se termină și noile informații de program sunt afișate pe ecran.



AVERTISMENT!

- Nu atingeți suprafața interioară a tamburului atunci când adăugați sau scoateți rufe în timpul unui program în derulare. Suprafața tamburului este fierbinte.

5.14 Funcția de parfumare

Citiți manualul ProScent pentru utilizarea acestei funcții, dacă uscătorul dvs. este prevăzut cu capabilitatea de parfumare.

5.12 Anularea programului

Dacă doriți să anulați programul și să încheiați operațiunea de uscare din orice motive după ce mașina începe să meargă, țineți apăsat butonul **On/Off/Cancel** preț de 3 secunde.



AVERTISMENT!

- Interiorul mașinii va fi extrem de încins atunci când anulați programul în timpul funcționării mașinii, deci rulați programul de ventilare pentru a-i permite să se răcească.

5.13 Terminarea programului

La finalul programului, simbolurile de avertizare Fibre Filter Cleaning (Curățare Filtru Scame) și Water Tank (Rezervor Apă) de pe indicatorul de monitorizare a programelor se aprind. Ușa de încărcare poate fi deschisă și mașina devine gata pentru încă o rundă.

Pentru a opri mașina, apăsați butonul **On/Off/Cancel**.

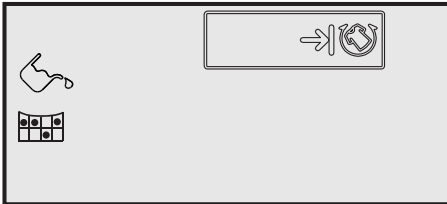

NOTĂ

- Funcția Antișifonare activează programul Antișifonare de două ore dacă rufe nu sunt luate din mașină după terminarea programului.
- Curățați filtrul de scame după fiecare uscare. Consultați 6.1 Curățarea filtrului de scame / Suprafața interioară a ușii de încărcare
- Goliți rezervorul de apă după fiecare uscare. Consultați 6.3 Golirea rezervorului de apă

6 Întreținerea și curățarea

6.1 Suprafața interioară a ușii de încărcare

Părul și scamele care sunt separate de rufe în timpul procesului de uscare este strâns de Filtrul de scame.

i NOTĂ

- Scamele se formează în timpul purtării și spălării hainelor.
- Puteți curăța compartimentul filtrului de scame cu un aspirator.



AVERTISMENT!

- După fiecare ciclu de uscare, curățați filtrul de scame și suprafața interioară a ușii de încărcare.

Pentru a curăța filtrul de scame:

- Deschideți ușa de încărcare.
- Țineți prima parte (filtrul interior) al filtrului de scame format din două părți și îndepărtați-l trăgând în sus.
- Curățați părul, scamele și resturile de bumbac manual sau cu o cârpă moale.
- Îndepărtați a doua parte (filtrul exterior) trăgându-l în sus.

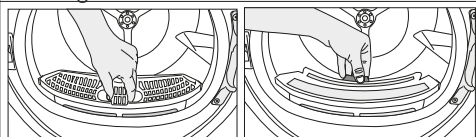

i NOTĂ

- Asigurați-vă că părul, scamele și resturile de bumbac nu cad în fanta în care sunt instalate filtrele.

- Deschideți ambele filtre de scame (filtrele interioare și exterioare) îndepărtați părul, scamele, resturile de bumbac cu mâna umedă, un aspirator sau o cârpă.

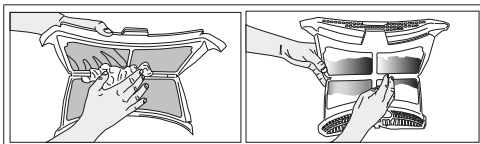

- Curățați ambele filtrele sub jetul de apă în direcție inversă a acumulării scamei sau cu o perie moale. Uscați filtrul înainte de a-l pune la loc.

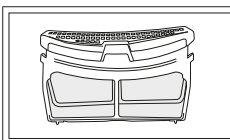
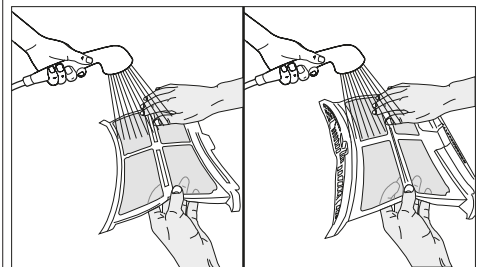

- Introduceți filtrele de scame unul în altul și puneți-le la loc.

- Curățați interiorul ușii de încărcare și spălătorul cu o cârpă moale și umedă.

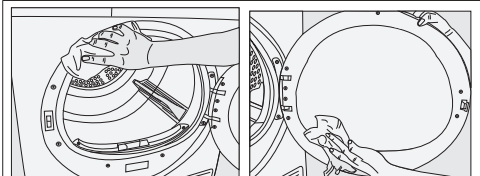

6.2 Curățarea senzorului

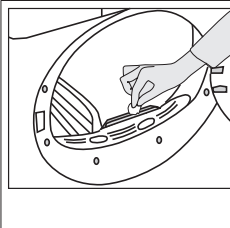

Există senzori de umiditate în uscător care detectează dacă rufe sunt sau nu uscate. Pentru a curăța senzorii:

- Deschideți ușa de încărcare a uscătorului.
- Permiteți mașinii să se răcească dacă este încă încinsă din cauza procesului de uscare.
- Ștergeți suprafețele metalice ale senzorului cu o cârpă moale, umezită cu oțet și uscați-le.



NOTĂ

- Curățați suprafețele metalice ale senzorilor de 4 ori pe an.
- Nu folosiți instrumente metalice atunci când curățați suprafețele metalice ale senzorilor.

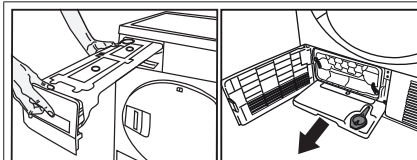

2. Goliți apa din rezervor.

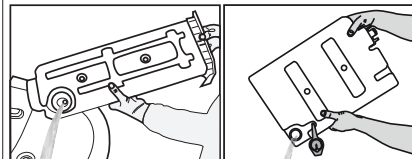

- Dacă există acumulare de scame în pâlnia rezervorului de apă, curățați-o sub apă curentă.
- Amplasați rezervorul de apă la locul său.



AVERTISMENT!

- Nu folosiți niciodată solvenți, agenți de curățare sau substanțe similare pentru curățare din cauza riscului de foc sau explozie!



NOTĂ

- Dacă aveți opțiunea de scurgere directă a apei, nu e nevoie să goliți rezervorul de apă.

6.3 Golirea rezervorului de apă

Umezeala rufelor este îndepărtată și condensată în timpul procesului de uscare și apa care crește se acumulează în rezervorul de apă. Goliți rezervorul de apă după fiecare ciclu de uscare.

6.4 Curățarea evaporatorului

Părul și fibrele care nu sunt prinse de filtrul de scame se acumulează în nervurile evaporatorului din spatele plintei. Dacă pictograma evaporator "E" clipește sau într-o perioadă de 6 luni, curățați evaporatorul.



AVERTISMENT!

- Apa condensată nu este potabilă!
- Nu îndepărtați niciodată rezervorul de apă atunci când programul rulează!

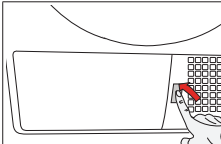

- Deschideți plinta apăsând pe ea.

Dacă uitați să goliți rezervorul de apă, mașina se va opri în timpul ciclurilor de uscare ulterioare atunci când rezervorul de apă este plin și simbolul de avertizare Rezervor Apă clipește. În acest caz, goliți rezervorul de apă și apăsați butonul Start / Pause pentru a relua ciclul de uscare.

Golirea rezervorului de apă:

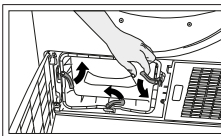

- Pentru a deschide ușa de rutare a aerului, mișcați mecanismul de eliberare.

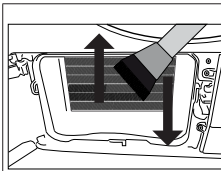

- Curățați scamele pe evaporator cu o cârpă umedă / cu un aspirator cu o perie printr-o mișcare în sus și în jos.

1. Scoateți cu grijă rezervorul de apă din sertar sau suport.

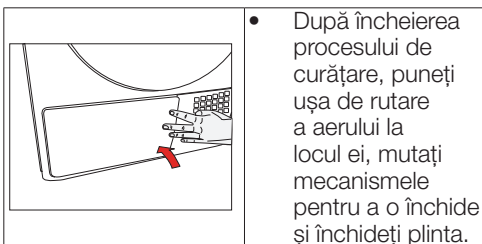

! AVERTISMENT!

- Puteți curăța manual, cu condiția să purtați mănuși protectoare. Nu încercați să curățați cu mâinile goale. Nervurile evaporatorului vă pot vătăma mâinile.
- Curățarea cu mișcări la stânga și la dreapta poate avaria nervurile evaporatorului. Acest lucru poate duce la probleme de uscare.

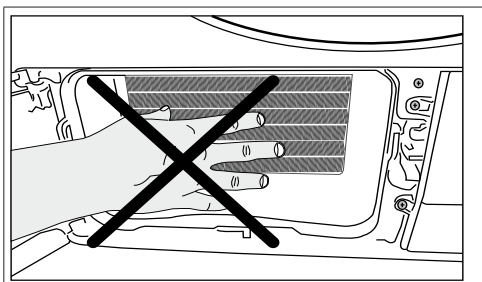

7 Depanare

Operațiunea de uscare durează prea mult.

Porii filtrului de scame (filtrul interior și exterior) poate fi înfundat. >>> Spălați filtrele de scame cu apă caldă și uscați-le.
Partea din față a evaporatorului poate fi înfundată. >>> Curățați partea din față a evaporatorului.
Grilele de aerisire din partea din față a mașinii ar putea fi obstrucționate. >>> Îndepărtați orice obiecte din fața grilelor de aerisire ce blochează fluxul de aer.
Ventilarea ar putea fi insuficientă datorită faptului că spațiul în care este instalată mașina este prea mic. >>> Deschideți ușa sau fereastra pentru a evita creșterea excesivă a temperaturii în cameră
Posibilă acumulare de calcar pe senzorul de umiditate.
>>> Curățați senzorul de umiditate.
Încărcare excesivă cu rufe. >>> Nu încărcăți uscătorul excesiv.
Este posibil ca rufe să nu fi fost centrifugate în mod adecvat. >>> Efectuați o centrifugare la turație mai mare.

Hainele sunt umede după uscare.

Este posibil să se fi folosit un program necorespunzător pentru tipul de rufe.>>> Verificați etichetele de întreținere de pe haine și selectați un program corespunzător cu tipul de haine sau folosiți suplimentar un program de durată.
Porii filtrului de scame (filtrul interior și exterior) poate fi înfundat. >>> Spălați filtrele de scame cu apă caldă și uscați-le.
Partea din față a evaporatorului poate fi înfundată. >>> Curățați partea din față a evaporatorului.
Încărcare excesivă cu rufe. >>> Nu încărcăți uscătorul excesiv.
Este posibil ca rufe să nu fi fost centrifugate în mod adecvat. >>> Efectuați o centrifugare la turație mai mare.

Uscătorul nu pornește sau un program nu poate fi pornit. Uscătorul nu pornește după ce este programat.

Cablul de alimentare ar putea fi deconectat. >>> Asigurați-vă de conectarea cablului de alimentare.
Ușa de încărcare ar putea fi deschisă. >>> Asigurați-vă că ușa de încărcare este bine închisă.
Un program ar putea să nu fie setat sau butonul Start / Pause / Cancel (Start/Pauză/Anulare) ar putea să nu fie apăsat. >>> Verificați ca programul să fie setat și să nu fie pe poziția de Pauză.
Blocarea de siguranță pentru copii ar putea fi activată. >>> Dezactivați blocarea de siguranță pentru copii.

Programul a fost întrerupt fără motiv.

Este posibil ca ușa de încărcare să nu fi fost închisă bine. >>> Asigurați-vă că ușa de încărcare este bine închisă.
Ar putea exista o întrerupere de curent. >>> Apăsăți butonul Start/Pause/Cancel (Start/Pauză/Anulare) pentru a începe programul.
E posibil ca rezervorul de apă să fie plin. >>> Goliți rezervorul de apă.

Hainele s-au micșorat, s-au întărit sau s-au deteriorat.

Este posibil să se fi folosit un program necorespunzător cu tipul de haine. >>> Verificați etichetele de întreținere de pe haine și selectați un program adecvat tipului acestora.

Scurgeri de apă de la ușa de încărcare.

S-au acumulat scame pe suprafețele interne ale ușii de încărcare și pe garnitura ușii de încărcare. >>> Curățați suprafețele interioare ale ușii de încărcare și pe cele ale garniturii ușii de încărcare.

Ușa de încărcare se deschide singură.

Este posibil ca ușa de încărcare să nu fi fost închisă bine. >>> Apăsăți ușa de încărcare până ce se aude sunetul de închidere.

Simbolul de avertizare rezervor apă se aprinde sau clipește.

E posibil ca rezervorul de apă să fie plin. >>> Goliți rezervorul de apă.
Furtunul de golire a apei poate fi defect. >>> Dacă produsul este conectat direct la rețeaua de scurgere a menajeriei, verificați furtunul de scurgere a apei.

Lumina din interiorul uscătorului nu se aprinde. (La modelele cu lămpi)

Este posibil ca uscătorul să nu fi fost pornit folosind butonul On/Off (Pomire/Oprire). >>> Asigurați-vă că uscătorul este pornit.
E posibil ca lampa să nu funcționeze. >>> Contactați un Service Autorizat pentru a înlocui lampa.

Pictograma de antișifonare e aprinsă.

Este posibil să fi activat modul de antișifonare care împiedică rufe din uscător să se șifoneze. >>> Oprți uscătorul și scoateți rufe.

Pictograma de curățare a filtrului de scame este aprinsă.

Filtrul de scame (filtrul interior și exterior) poate fi murdar. >>> Spălați filtrele de scame cu apă caldă și uscați-le.
Se poate forma un strat pe porii filtrului de scame care duce la înfundare. >>> Spălați filtrele de scame cu apă caldă și uscați-le.
Este posibil ca filtrele de scame să nu fie introduse. >>> Introduceți filtrele interior și exterior la locurile lor.

O avertizare sonoră se aude din mașină.

Este posibil ca filtrele de scame să nu fie introduse. >>> Introduceți filtrele interior și exterior la locurile lor.

Pictograma de avertizare a evaporatorului clipește.

Partea din față a evaporatorului poate fi înfundată cu scame. >>> Curățați partea din față a evaporatorului.
Este posibil ca filtrele de scame să nu fie introduse. >>> Introduceți filtrele interior și exterior la locurile lor.

Lumina din interiorul uscătorului se aprinde. (La modelele cu lămpi)

Dacă uscătorul este conectat la priză, butonul On/Off (Pornit/Oprit) este apăsat și ușa se deschide; lumina se aprinde. >>> Scoateți din priză uscătorul sau treceți butonul On/Off (Pornit/Oprit) în poziția Off (Oprit).



AVERTISMENT!

- Dacă problema persistă după ce ați urmat instrucțiunile din acest capitol, contactați distribuitorul dvs. sau un centru de service autorizat. Nu încercați niciodată să vă reparați singur aparatul.



NOTĂ

- În cazul în care întâmpinați o problemă de orice fel la aparat, puteți solicita înlocuirea contactând un service autorizat cu numărul de model al aparatului.
- Operarea aparatului cu părți neautentice poate duce la defectarea aparatului.
- Producătorul și distribuitorul nu răspund de defectele care rezultă din părțile neautentice.

FIȘĂ PRODUS

REGULAMENTUL DELEGAT (UE) NR. 392/2012 AL COMISIEI

Nume furnizor și marcă înregistrată		BEKO
Denumire model		DS8444RX 7188233810
Capacitate nominală (kg)		8.0
Tip uscător	Ventilat	-
	Condensator	•
Clasa eficienței consumului de energie ⁽¹⁾		A++
Consum anual de energie (kWh) ⁽²⁾		234,7
Tip Control	Automat	•
	Neautomat	-
Consum energie program bumbac standard la încărcare maximă (kWh)		1,97
Consum energie program bumbac standard la încărcare maximă parțială (kWh)		1,08
Consumul de energie al modului off (oprit) pentru programul standard pentru bumbac la capacitate maximă, P ₀ (W)		0,10
Consumul de energie al modului left-on (lăsat pornit) pentru programul standard pentru bumbac la capacitate maximă, P ₁ (W)		1,00
Durata modului lăsat pornit (min)		30
Program bumbac standard ⁽³⁾		
Timp program bumbac standard la încărcare maximă, T _{dy} (min)		197
Timp program bumbac standard la încărcare parțială, T _{dy1/2} (min)		125
Timp program ponderat bumbac standard la încărcare maximă și încărcare parțială (T ₁)		156
Clasa eficienței condensării ⁽⁴⁾		B
Eficiență condensare medie program bumbac standard la încărcare parțială, C _{dy}		85%
Eficiență condensare medie program bumbac standard la încărcare parțială, C _{dy1/2}		85%
Eficiență ponderată program bumbac standard la încărcare maximă și încărcare parțială, C ₁		85%
Nivel putere sunet program bumbac standard la încărcare maximă ⁽⁵⁾		65
Integrat		-

• : Da - : Nu

(1) Scara de la A+++ (cea mai mare eficiență) la D (cea mai mică eficiență)

(2) Consum energie pe baza a 160 cicluri de uscare a programului bumbac standard la încărcare maximă și parțială, și consumul modurilor cu putere redusă. Consumul de energie real per ciclu va depinde de modul de folosire al aparatului.

(3) "Programul de uscare bumbac pentru dulap" folosit la capacitate maximă și parțială este programul de uscare standard la care se referă informațiile de pe etichetă și din fișa tehnică, adică acest program este adecvat pentru uscarea lenjeriei de bumbac normală udă și că este cel mai eficient program în termeni de consum de energie pentru bumbac.

(4) Scara de la G (cea mai mică eficiență) la A (cea mai mare eficiență)

(5) Valoare ponderată medie — L_{WA} exprimată în dB(A) re 1 pW

Kérjük, először olvassa el a használati útmutatót!

Kedves Vásárló!

Köszönjük, hogy egy Beko terméket választott. Reméljük, hogy az ön által megvásárolt, korszerű körülmények között gyártott gép a legjobb eredményt nyújtja majd önnek. Azt tanácsoljuk, hogy az első használat előtt alaposan olvassa végig ezt a használati útmutatót és a kísérő dokumentumokat, majd tartsa azt meg a továbbiakban is. Ha másnak adná át a terméket, mellékelje a használati útmutatót is. Ügyeljen az útmutatóban található részletekre és a figyelmeztetésekre, és kövesse azokat. Ezt a használati útmutatót a fedlapján látható modellhez használja.



- Olvassa el a használati útmutatót.

Jelmagyarázat

A használati útmutatóban a következő jelzések fordulnak elő:



VESZÉLY!

- Áramütéssel kapcsolatos figyelmeztetés.



VESZÉLY!

- Tűzveszéllyel kapcsolatos figyelmeztetés.



FIGYELMEZTETÉS!

- A veszélyes helyzetekkel kapcsolatos figyelmeztetések, tekintettel az élet- és vagyonbiztonságra.



FIGYELMEZTETÉS!

- Forró felületekkel kapcsolatos figyelmeztetés.



FIGYELMEZTETÉS!

- Figyelmeztetés a leforrzás veszélyére



MEGJEGYZÉS

- Fontos információk, illetve a használattal kapcsolatos hasznos útmutatók.



A termék csomagolóanyagait, a nemzeti környezetvédelmi szabályzásnak megfelelően újrahasznosítható anyagokból gyártottuk.

Ne dobja ki a csomagolóanyagokat háztartási vagy más hulladékkal együtt, azokat a helyi hatóságok által kijelölt csomagolóanyag gyűjtőpontoknál dobja ki.



1 Fontos utasítások a biztonság és környezet kapcsán



MEGJEGYZÉS

- Ez a fejezet olyan biztonsági információkat tartalmaz, melyek segítenek megelőzni a személyi sérülések és az anyagi károk kockázatát. Az előírások figyelmen kívül hagyása a garancia elvesztésével jár.

1.1 General safety



FIGYELMEZTETÉS!

- A készülék használható 8 éves és ennél nagyobb gyermekek által, valamint csökkentett fizikális, érzékelési vagy mentális készségekkel rendelkező személyek által, vagy tapasztalattal és tudással nem rendelkező személyek által, ha őket a biztonságukért felelős személy a készülék használatával kapcsolatban tájékoztatással vagy iránymutatással látta el. Ne hagyja a gyermekeket a készülékkel játszani. A tisztítási és karbantartási műveleteket gyermekek felügyelet nélkül nem végezhetik.
- Ha a gyermekek nincsenek folyamatos felügyelet alatt, tartsa távol a 3 éven aluli gyermekeket.
- Az állítható lábat nem szabad eltávolítani. A szárító és a padló közötti távolságot nem szabad olyan anyagokkal csökkenteni, mint pl. a szőnyeg, fa vagy a szerelőszalag. Ez problémákat okoz a szárítónál.



FIGYELMEZTETÉS!

- A beszerelési és javítási munkákat mindig bízza Szakszervizre. A gyártó nem vállal felelősséget azokért a károkért, melyek képzetlen személy által végzett javítási munkák következtében következnek be.
- Soha ne tisztítsa úgy a szárítót, hogy vizet permetez vagy borít rá! Ezzel áramütés veszélyének teszi ki magát

Gőzölő funkcióval rendelkező termékek esetében:



FIGYELMEZTETÉS!

- Csak desztillált vizet vagy a gép víztartályában lecsapódott vizet használja a gőzölős programokkal. Ne használjon vezetékes vizet vagy adalékanyagokat. A víztartályban összegyűlt víz használata során szűrje meg és távolítsa el belőle a szálakat.
- A gőzölő program üzeme közben ne nyissa ki az ajtót. Forró víz csapódhat ki.
- Mielőtt gőzölő programot állít be a ruhának, távolítsa el a foltokat.
- Csak olyan ruhákhoz állítsa be a gőzölő programot, amelyek nem piszkosak vagy foltosak, csak valamilyen kellemetlen szag járja át őket (szageltávolító).
- Sem a gőzölő, sem más program során ne használjon vegytisztító szereket vagy kiegészítő anyagokat.

1.1.1 Electrical safety



VESZÉLY!

- **Az elektromos biztonsági utasításokat a beszerelés során az elektromos csatlakozással kapcsolatban követni kell.**
- **A berendezést tilos külső kapcsoló berendezésen keresztül csatlakoztatni, mint amilyenek az időzítő, vagy olyan áramkörre kapcsolni, amelyet egy berendezés rendszeresen bekapcsol és kikapcsol.**
- Az olajjal, acetonnal, alkohollal, fűtőolajjal, kerozinnal, feltöltővel szerelvényekkel, terpentinrel, paraffinnal, paraffin eltávolító szerrel, benzinnel, viasszal vagy viaszos eltávolító szerrel szennyezett tárgyakat bő vízzel kell lemosni, mielőtt a szárítóban szárítanák.
- A feszültség és a megengedett biztosítékos védelem adatait a típuscímke lemezen találja.
- A típuscímken látható feszültségnek meg kell egyeznie a hálózati feszültséggel.
- Ha nincs használatban a szárító, áramtalanítsa.
- Telepítés, karbantartás, tisztítás és javítási munkálatok közben, húzza ki a szárítót a hálózati csatlakozóból.



VESZÉLY!

- Nedves kézzel ne érintse meg a csatlakozót! Az áramtalanítást soha ne a zsinór húzásával végezze, mindig a csatlakozónál fogva húzza ki.
- Az áramütés és tűz kockázatának csökkentése érdekében, a szárítót ne csatlakoztassa hosszabbítókkal, többdugaszos aljzatokkal vagy adapterekkel az elektromos hálózathoz.
- A gép beszerelése után a tápkábel dugójának könnyen hozzáférhetőnek kell lennie.
- **A sérült tápkábelt a szakszerviz értesítésével le kell cserélni.**
- **Ha a készülék meghibásodása esetén, a javítás szakszervizzel való elvégzéséig nem üzemeltethető! Ezzel áramütés veszélyének teszi ki magát!**

1.1.2 Termék biztonság



FIGYELMEZTETÉS!

- Győződjön meg arról, hogy a szárító levegő bemenete nyitva van, és jól szellőzik.
- A termék R290 hűtőközeget tartalmaz.
- Az R290 egy környezetbarát, de gyúlékony hűtőközeg.
- Tartsa távol a terméket olyan potenciális hőforrásoktól, amelyek meggyulladhatnak.



VESZÉLY!

A tűzveszéllyel kapcsolatosan megfontolandó pontok:

- A meghatározott mosott cikkeken kívül, más nem szárítható a szárítóban, tűzveszély miatt.
- Mosatlan ruhaneműk
- A olajjal, acetonnal, alkohollal, gázolajjal, kerozinnal, folteltávolítóval, terpentinnel, parafinnal vagy parafin-eltávolítóval szennyezett ruhaneműt a szárítás előtt forró, oldószeres vízben kell lemosni.
- Ezért, főleg az olyan anyagokat melyekben a fent meghatározott foltok vannak, alaposan ki kell mosni, ahhoz megfelelő mosószert kell használni, magas mosási hőmérsékleten.

Az alább meghatározott mosott cikkeken kívül, más nem szárítható a szárítóban, tűzveszély miatt:



VESZÉLY!

- Gumihabbal (latex hab) bevont ruhák vagy párnák, fürdőköpenyek, vízálló textíliák, gumi erősítéssel ellátott anyagok és gumihab betétek.
- Ipari kemikáliákkal tisztított ruházat.
- Az olyan tárgyak, mint az öngyújtó, gyufa, aprópénz, fém alkatrészek, tű, stb. károsíthatják a dobot vagy működési problémákhoz vezethetnek. Ezért, ellenőrizze a ruhát, amit a szárítóba kíván tenni.
- Soha ne állítsa meg a szárítót mielőtt a program befejeződné. Ha mégis így kell tennie, távolítsa el a ruhát gyorsan, és fektesse le azokat hogy eloszlassa a hőt. A nem megfelelően mosott ruhák maguktól meggyulladhatnak, még az után is, hogy a szárítás befejeződött.
- Gondoskodnia kell a megfelelő szellőztetésről annak érdekében, hogy az eltérő üzemanyagokkal (pl. nyílt lánggal) üzemelő gépek által kibocsátott gázok ne gyűljenek fel a helységben az utógyújtás hatás miatt.



FIGYELMEZTETÉS!

- Fémrészeket is tartalmazó alsónemű nem szárítható a szárítóban. A szárítógép meghibásodásához vezethet, ha a szárítás alatt a fém részek meglazulnak és letörnek.



MEGJEGYZÉS

- Az öblítőket és hasonló termékeket a gyártó útmutatásai szerint használja.
- Az egyes betöltések előtt vagy után mindig tisztítsa meg a szűrőt. A szárítót soha ne használja bolyhszűrő nélkül.



FIGYELMEZTETÉS!

- Soha ne próbálja saját maga megjavítani a terméket. Hacsak a használati útmutató vagy a szervizkönyv kifejezetten ezt nem javasolja, ne kíséreljen meg semmiféle javítási vagy cserélési műveletet a terméken, még akkor sem, ha tudja, hogy azt hogyan kell kivitelezni. Ellenkező esetben saját és mások életét veszélyezteti.
- Ahol a szárítót beszerelik, nem lehet olyan zárható, toló, vagy zsanéros ajtó, mely akadályozhatja a betöltő ajtó kinyitását.
- Olyan helyre szerelje be a szárítót ami megfelel az otthoni használatnak. (Fürdőszoba, zárt balkon, garázs, stb.)
- Ügyeljen arra, hogy a háziállatok ne másszanak bele a szárító. Használat előtt ellenőrizze a szárító dobját.
- Ne támaszkodjon a szárító betöltő ajtajára amikor az nyitva van, mert az leeshet.
- Ne hagyja, hogy sok szösz gyűljön össze a szárítógép körül.

1.2 Mounting over a washing machine

- Ha a készüléket a mosógép felett kívánja használni, akkor a két gép között rögzítő eszközt kell alkalmazni. A rögzítő eszközt szakképzett személynek kell beszerelnie.
- Ha a mosógép és a szárítógép egymásra van helyezve, teljes töltet esetén körülbelül 180 kg-ot nyomnak együtt. A készülékeket olyan, egyenes talajra helyezze, mely megfelelő teherbírással rendelkezik!



FIGYELMEZTETÉS!

- A mosógépet nem szabad a szárítóra helyezni. A mosógépre való felszerelésekor, figyeljen oda a fent leírt utasításokra.

Beszerelési táblázat a mosógéphez és a szárítóhoz

	Mosógép mélysége			
Szárítógép mélysége	62 cm	60 cm	54 cm	< 50 cm
54 cm	Beszerelhető		Nem beszerelhető	
60 cm	Beszerelhető		Nem beszerelhető	

1.3 Rendeltetészerű használat

- A szárítót otthoni használatra tervezték. Kereskedelmi célra valamint a rendeltetésétől eltérő módon nem használható.
- A szárítót csak olyan ruhanemű szárításához használhatja, melyen ez megfelelően jelezve van.
- A gyártó elhárítja a helytelen használatból vagy szállításból származó felelősséget.
- Az Ön által megvásárolt szárító élettartama 10 év. Ez idő alatt a szárító megfelelő működtetéséhez elérhetőek lesznek az eredeti pótalkatrészek..

1.4 Gyermekek biztonsága

- A csomagolóanyagok veszélyesek a gyermekek számára. A csomagolóanyagokat tartsa távol a gyermekektől.
- Az elektromos berendezések veszélyesek a gyermekekre nézve. Ha a gép működik, a gyermekeket ne engedje a közelébe! Ne hagyja, hogy játsszanak a szárítóval! Használjon gyerekbiztos zárat, hogy elkerülje azt, hogy a gyermekek a szárítóval játsszanak.



MEGJEGYZÉS

A gyerekbiztos zár a vezérlőpanelen található. (Lásd Gyerekzár)

- Tartsa zárva a betöltőajtót még akkor is, amikor nem használja a szárítót.

1.5 Megfelelés a WEEE előírásnak és a termék leselejtezése



A termék megfelel az uniós WEEE-irányelv (2012/19/EU) követelményeinek. A terméken megtalálható az elektromos és elektronikus hulladékok

besorolására vonatkozó szimbólum (WEEE).

A terméket magas minőségű alkatrészekből és anyagokból állították elő, amelyek ismételt felhasználhatók és alkalmasak az újrahasznosításra. A hulladék terméket annak élettartamának végén ne a szokásos háztartási vagy egyéb hulladékkal együtt selejtezze le. Vigye el azt egy az elektromos és elektronikus berendezések újrahasznosítására szakosodott begyűjtőhelyre. A begyűjtőhelyek kapcsán kérjük, tájékozódjon a helyi hatóságoknál.



VESZÉLY!

- Az R290 egy gyúlékony hűtőközeg. Ezért győződjön meg róla, hogy a rendszer és a csövek nem sérültek-e a működés és a kezelés során.
- Tartsa távol a terméket olyan potenciális hőforrásoktól, amelyek sérülés esetén meggyulladhatnak.
- Ne dobja a terméket tűzbe.

1.6 Az RoHS-irányelvnek való megfelelés:

Az Ön által megvásárolt termék megfelel az uniós RoHS-irányelv (2011/65/EU)

követelményeinek. A termék nem tartalmaz az irányelvben meghatározott káros vagy tiltott anyagokat.

1.7 Csomagolási információ

A termék csomagolóanyagai, a nemzeti környezetvédelmi előírásokkal összhangban, újrahasznosítható anyagokból készültek. A csomagolóanyagokat ne a háztartási vagy egyéb hulladékokkal együtt dobja ki! Vigye el azokat a helyi hatóságok által e célból kijelölt csomagolóanyag-begyűjtő pontokra.

1.8 Műszaki Specifikációk

HU

Magasság (min. / max.)	84,6 cm / 86,6 cm*
Szélesség	59,7 cm
Mélység	58,9 cm
Kapacitás (max.)	8 kg**
Nettó súly (± 4 kg)	44 kg
Feszültség	
Névleges bemeneti teljesítmény	Lásd a típuscímkét***
Modellkód	

* Min. magasság: Magasság zárt beállítólábakkal.

Max. magasság: Magasság maximálisan nyitott beállítólábakkal.

** Száraz szennyes súly mosás előtt.

*** A típuscímké a betöltőajtó mögött található.



MEGJEGYZÉS

- A szárító műszaki jellemzői előzetes értesítés nélkül megváltozhatnak a minőség fejlesztése érdekében.
- A jelen használati utasításban található értékek csak szemiatikus adatok, így elképzelhető, hogy nem egyeznek száz százalékban a termékkel.
- A szárító címkein vagy a dokumentumokon feltüntetett értékek laboratóriumi körülmények között kerültek meghatározásra, a vonatkozó szabványok szem előtt tartása mellett. A szárító működési és környezeti körülményektől függően az értékek eltérőek lehetnek.

2 Az Ön szárítógépe

2.1 Áttekintése

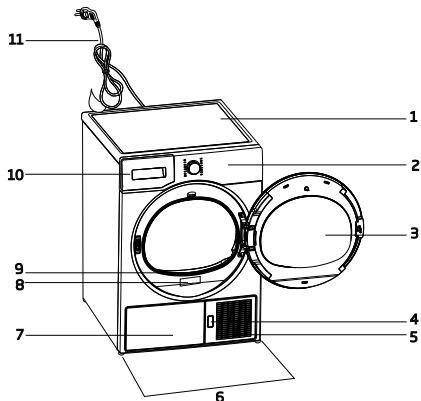

1. Felső panel
2. Vezérlőpanel
3. Betöltőajtó
4. Védőlemez nyitó gomb
5. Szellőzőrácsok
6. állítható lábak
7. Azokban a modellekben, amelyekben a tartály alul található, a víztartály a talplemezen belül van
8. Típusjelölő címke
9. Bolyhszűrő
10. Víztartály-fiók (azokban a modellekben, amelyekben a tartály felül található)
11. Tápkábel

2.2 A csomag tartalma

	1. Víz leeresztő cső		5. Szárítógép használati utasítás*
	2. Szűrőfiók pót- szivacs *		6. Víztöltő tartály*
	3. Használati útmutató		7. Tiszta víz*
	4. Szárító-kosár*		8. Illatkapszula csoport*

*A modelltől függően, tartozéka lehet a gépének.

3 Üzembe helyezés

Mielőtt az Önhöz legközelebbi szakszervizt kihívna a szárítógép bekötése céljából, győződjön meg, hogy az elektromos csatlakozás és a csatornabekötés megfelel a használati útmutatóban meghatározott követelményeknek. Ha nem megfelelőek, hívjon képesített villany-, illetve vízvezeték szerelőt a szükséges csatlakozás kialakítása érdekében.



MEGJEGYZÉS

- A szárítógép helyének előkészítése, valamint az elektromos és csatornahálózati bekötés a fogyasztó felelőssége.



FIGYELMEZTETÉS!

- Telepítés előtt szemrevételezéssel győződjön meg, hogy a szárítógép nem sérült. Ha a szárító sérült, ne végeztesse el a bekötését. A sérült termék használata balesetveszélyes lehet.
- A szárítógép használata előtt várjon 12 órát.

3.1 Megfelelő elhelyezés

A szárítót stabil, egyenletes felszínen helyezze el.

A szárítógép nehéz. Ne mozgassa egyedül.

- A szárítógépet jól szellőző, pormentés helyiségben használja.
- A szárítógép és a talaj közötti hézagot tilos kitölteni pl. szőnyeggel, fával vagy szalaggal.
- Ne takarja el a szárítógépe szellőzőnyílásait.
- A telepítés helyszínén nem lehet olyan zárható tolóajtó vagy zsanéros ajtó, amely akadályozza a gép töltőajtójának nyitását.
- A szárítógép telepítését követően a gépet azon a helyen kell hagyni, ahol a bekötést elvégezték. A gép telepítésekor győződjön meg, hogy annak hátfala nem ér semmihez (csap, aljzat stb.).
- Helyezze a szárítógépet legalább 1 cm távolságra más berendezési tárgyaktól.
- Az Ön szárítógépét +5°C és +35°C

közötti hőmérséklettartományban lehet működtetni. Ettől eltérő körülmények esetén az üzemeltetés a gépet károsíthatja.

- A szárítógép hátfalát állítsa a falhoz.



VESZÉLY!

A gépet ne állítsa rá a tápkábelre.

*** Hagyja figyelmen kívül a következő figyelmeztetést, ha a termék rendszere nem tartalmaz R290-et**



VESZÉLY!

- A szárító R290 hűtőközeget tartalmaz.*
- Az R290 egy környezetbarát, de gyúlékony hűtőközeg.*
- Győződjön meg arról, hogy a szárító levegő bemenete nyitva van, és jól szellőzik.*
- Tartsa távol a potenciális lángforrásokat a szárítótól.*

3.2 A szállítási biztosító szerelvények eltávolítása



FIGYELMEZTETÉS!

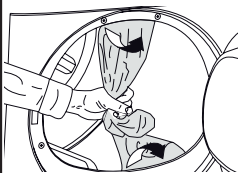

- A szárítógép első használata előtt a szállítási biztosító szerelvényeket el kell távolítani.
- Amennyiben az ajtó nyílásiránya megfordítható, ehhez kövesse a az ajtó szerelésére vonatkozó utasításokat.

3.3 Csatornabekötés

A víztartályban összegyűlt víz időszakos ürítése helyett a vizet a termékkel kapott tömlőn keresztül közvetlenül is ürítheti.

A vízleeresztő tömlő csatlakoztatása

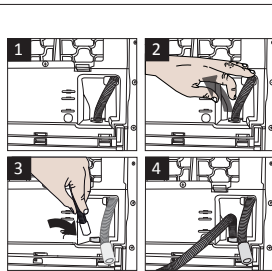

1-2 Kézzeel húzza át a tömlőt a szárító mögött, lecsatlakoztatva a rögzítési helyéről. A tömlő levételéhez ne használjon szerszámot.

- 3** A szárítógéppel kapott leeresztő tömlő egyik végét csatlakoztassa ahhoz a csatlakozási ponthoz, ahonnan az előző pontban levette.
- 4** A leeresztő tömlő másik végét csatlakoztassa közvetlenül a csatornahálózati csomagra, vagy a mosdókagylóhoz.



MEGJEGYZÉS

- A leeresztő tömlő csatlakoztatási magassága max. 80 cm lehet.
- Ügyeljen, hogy a leeresztő tömlőre ne lépjenek, és az ne szoruljon be a gép és a szerelvény közé.
- Amennyiben a termékhez tartozék csomagot is mellékeltek, lásd a részletes leírást.

3.4 A lábak beállítása

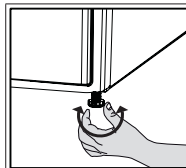

- A lábak jobbra vagy balra forgatásával állítsa a szárítógépet stabil vízszintes helyzetbe.

3.5 A szárítógép szállítása

Ürítsen ki minden vizet, ami esetleg a gépben maradt. Ha a gép közvetlenül a csatornabekötő csomagra van csatlakoztatva, csatlakoztassa azt le.



FIGYELMEZTETÉS!

- Javasoljuk, hogy a szárítógépet csak függőleges helyzetben mozgassák. Ha nem lehetséges a függőleges helyzetben való mozgatás, akkor javasoljuk, hogy az előlétzetről jobb kéz felőli oldala felé döntsék meg.

3.6 Hangokra vonatkozó figyelmeztetések



MEGJEGYZÉS

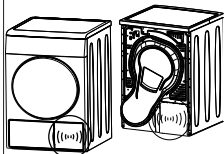

- A működés közben a kompresszor irányából jövő időnkénti fémes zaj normális jelenség.

- A működés közben összegyűlt vizet a gép a víztartályba szivattyúzza. E folyamat során a szivattyúzás zaja normális jelenség.

3.7 A megvilágító izzó cseréje

Ha az Ön készülékében van megvilágítás, az izzó/LED cseréje érdekében hívja a szakszervizt. A szárítógépben használt izzó szokásos háztartási célokra nem használható. A megvilágítás célja, hogy a szárítógép töltését megkönnyítse, kényelmesebbé tegye. A készülékben használt izzó szélsőséges körülményeknek is ellenáll, pl. rezgéseknek és az 50°C-nál magasabb hőmérsékletnek is.

4 Előkészítés

4.1 Gépi szárításra alkalmas ruhaneműk

Mindig tartsa be a ruhanemű címkéjén megadott utasításokat. Csak olyan ruhát szárítson, amely rendelkezik a szárítóban való szárításra alkalmasságot igazoló címkével.

4.2 Gépi szárításra nem alkalmas ruhaneműk



Az ezzel a szimbóolummal ellátott ruhaneműt ne szárítsa szárítóban



MEGJEGYZÉS

- A finom hímzett anyagok, a gyapjú, selyem ruhák, a finom és értékes anyagok, a légzáró anyagok és a túll függönyök nem alkalmasak gépi szárításra.

4.3 A ruhák előkészítése a szárításra

- A mosást követően a ruhanemű összegubancolódhat. Mielőtt a szárítóba helyezi őket, csoportosítsa a ruhaneműt.
- Szárítsa a fém részeket tartalmazó ruhaneműt kifordítva (pl. cipzár).
- Zárja be a cipzárakat, kampókat, csatokat és gombokat.

4.4 Teendők az energiatakarékosság jegyében

- Centrifugáláskor mindig a lehető legmagasabb sebességfokozatot használja. Ily módon a szárítási idő lerövidíthető, az energiafogyasztás pedig csökkenthető.
- A ruhákat típus és vastagság szerint válogassa. Az azonos típusú ruhaneműt együtt szárítsa. Például, a vékony anyagú konyharuhák és asztalterítők gyorsabban száradnak, mint a vastagabb törölközők.
- A megfelelő program kiválasztását illetően tekintse meg a használati útmutatót.
- Szárítás közben ne nyissa ki a gép betöltő ajtaját, csak ha feltétlenül szükséges. Ha mindenképp ki kell nyitnia, csak a lehető legrövidebb ideig tartsa nyitva.
- Működése közben ne adjon hozzá vizes ruhát a szárítóhoz

- Kondenzátor egységgel rendelkező modellek esetében: havonta egyszer vagy minden 30. használatot követően tisztítsa meg a kondenzátort.
- Hőszivattyú egységgel rendelkező modellek esetében: tisztítsa rendszeresen a szűrőfiókot, amikor szemmel láthatóan összegyűlt a szősz, vagy amikor a szűrőfiók-tisztítás jelzőfény felvillan.
- Kürtös modellek esetében: kövesse a kürtő csatlakoztatására vonatkozó utasításokat, és tisztítsa ki a kürtőt.
- A szárítási folyamat során jól szellőztesse ki a helyiséget, ahol a szárítógép működik.

4.5 Helyes ruhamennyiség

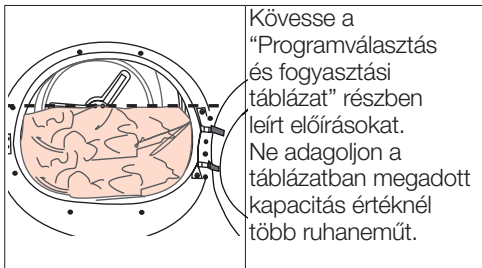

Az alábbi súlyok példaként szerepelnek:

Szennyes	Körülbelüli súly (g)*	Szennyes	Körülbelüli súly (g)*
Pamut paplanhuzat (dupla)	1500	Blúz	150
Pamut paplanhuzat (szimpla)	1000	Pamut ing	300
Lepedő (dupla)	500	Ingek	250
Lepedő (szimpla)	350	Pamut ruha	500
Nagy asztalterítő	700	Ruha	350
Kis asztalterítő	250	Farmer	700
Szalvéta	100	Zsebkendő (10 db)	100
Törölköző	700	Póló	125
Kéztörölő	350		

*Szárász szennyes súly mosás előtt..

5 A termék használata

5.1 Kezelőpanel

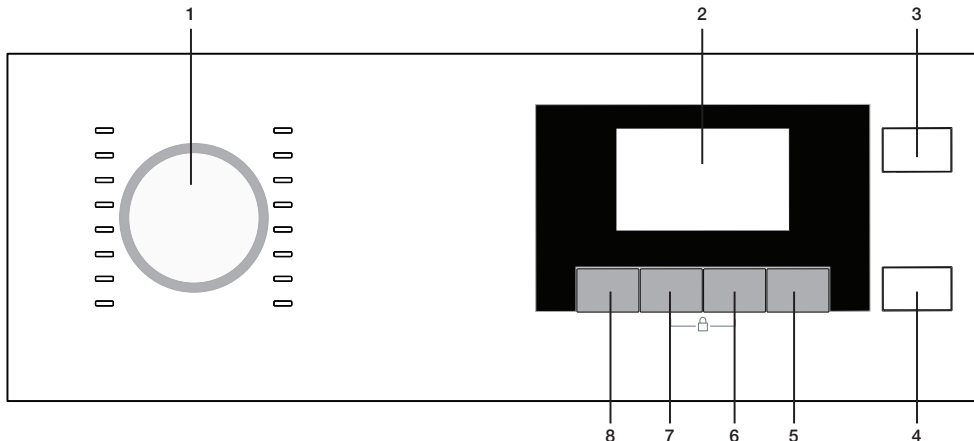

- | | |
|---------------------------|------------------------------------|
| 1. Programválasztó gomb | 5. Idő vége gomb |
| 2. Képernyő | 6. Időzítő programok beállító gomb |
| 3. Be-Ki gomb | 7. Hangfigyelmeztetés gomb |
| 4. Start/Bekapcsolva gomb | 8. Nedvesség szint beállító gomb |

5.2 Kijelző szimbólumok

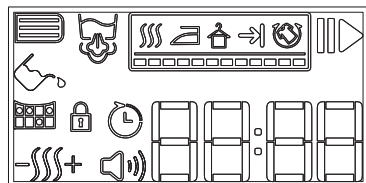

- | | |
|--|-----------------------------------|
| Hangjelzés szint jelzés | Szekrény száraz |
| Filter fiók tisztítás figyelmeztető jelzés | Gyerekbiztos figyelmeztető jelzés |
| Filter tisztítás figyelmeztető jelzés | Gyerekbiztos figyelmeztető jelzés |
| Víz tartály figyelmeztető jelzés | Ciklus vége |
| Start/tart jelzés | Gyürődés mentes |
| Gőz jelzés | Vége |
| Szárazság szint | Hátalévő idő kijelző* |
| Vasaló száraz | |

* A kijelzett idő a ciklus végéig fennmaradó időt jelzi és ez az idő függ a szárított ruha nedvesség tartalmától.

5.3 A szárítógép előkészítése

Csatlakoztassa a szárítógépet
Nyissa ki a berendezés ajtaját.
Helyezze a ruhaneműt lazán a dobba.
Nyomással csukja be az ajtót.

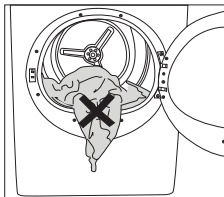

MEGJEGYZÉS

- Gondoskodjon, hogy ne legyen semmi az ajtó és az eszközök között az ajtó becsukásakor.

Nyomja le és tartsa lenyomva 1 másodpercig a **Bekapcsol/Kikapcsol/Töröl** gombot.

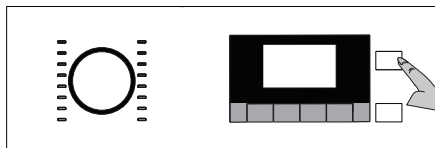

- Amikor először használja a szárítót, az alap program (Pamut szekrény száraz) kerül kiválasztásra.



MEGJEGYZÉS

- A program nem indul el azonnal csak a **Bekapcsol/Kikapcsol/Töröl** gomb lenyomásával. Indítsa el a programot a **Bekapcsol/Kikapcsol/Töröl** gombbal a program kiválasztása után.

5.4 Programválasztás

Az Ön szárító gépe 16 különböző programmal rendelkezik.

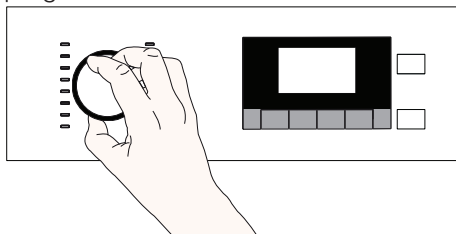

- Válassza ki a kívánt programot a kiválasztás gomb segítségével.
- A feltüntetett program kiválasztás és fogyasztás táblázat a felhasználók többségének választásán alapul.

5.5 Programkiválasztás és fogyasztási táblázat

HU				
Programok	A programok leírása	Kapacitás (kg)	A mosódob forgási sebessége (ford/perc)	Szárítási idő (perc)
Pamut, vasalásra kész	A vasalandó pamut ruhaneműt száríthatja ezzel a programmal, hogy az egyszerűbb vasalás érdekében egy kicsit nyirkosak legyenek. (ingek, pólók, abroszok stb.)	8	1000	145
Pamut Eko	Ezzel a programmal az összes pamut ruhaneműt száríthatja. (ingek, nadrágok, pizsamák, csecsemőruhák, fehérnemű, ágynemű stb.) A szekrénybe helyezés előtt nincs szükség vasalásra.	8	1000	197
Pamut, szekrényszárász	Ezt a programot vastag ruhaneműk, pl. nadrágok, tréningruhák extra szárításhoz használhatja. A szekrénybe helyezés előtt nincs szükség vasalásra.	8	1000	205
Pamut, extra szárász	Ezzel a programmal vastag pamut ruhaneműket száríthat, mint pl. törölközők, köntös stb. A szekrénybe helyezés előtt nincs szükség vasalásra.	8	1000	210
Szintetikus, vasalásra kész	A vasalandó szintetikus ruhaneműt száríthatja ezzel a programmal, hogy az egyszerűbb vasalás érdekében egy kicsit nyirkosak legyenek. (ingek, pólók, abroszok stb.)	4	800	60
Szintetikus, szekrényszárász	Ezzel a programmal az összes szintetikus ruhaneműt száríthatja. (ingek, pólók, alsónemű, abroszok stb.) A szekrénybe helyezés előtt nincs szükség vasalásra.	4	800	70
Szárító rekesz/ Időszárító	A 10 és 160 perc közötti időprogramok közül választhat a kívánt szárítási szint alacsony hőmérsékleten történő eléréséhez. Ebben a programban a szárítógép működése a ruhanemű szárazságától függetlenül a beállított ideig tart. Ez a termék opcionálisan szárítókosárral használható változatban is kapható. A kosár nélküli értékesített termékek esetében a hivatalos szerviztől vásárolhat kosarat, majd használhatja a fent megadott szárítási programokat. A használatra vonatkozó részletes információt lásd a szárítókosár használati útmutatójában.	-	-	-
Frissítés (Gyapjú frissítés)	Forró levegő befúvása nélkül 10 percig szellőztet. A programnak köszönhetően kiszellőztetheti a hosszú ideig zárt helyen tartott ruhákat, megszabadítva azokat a kellemetlen szagoktól. Használja ezt a programot mosógépben mosható gyapjú ruhanemű szellőztetéséhez és lágyításához. Ne használja teljes szárításhoz.	-	-	10
Finom textilák	A szárításra alkalmas különösen finom ruhanemű (selyemblúzok, finom alsónemű stb.), illetve azok, amelyeket ajánlatos kézzel mosni, ezzel a programmal alacsonyabb hőmérsékleten száríthatók.	1,5	1200	70
Farmer	Ezzel a programmal farmernadrágokat, -szoknyákat, -ingeket vagy -kabátokat száríthat.	4	1200	150
Szabadidő / Sport (Goretex)	Szárítsa meg a szintetikus, pamut vagy vegyes textilákából vagy vízálló anyagból készült ruháit, például funkcionális dzsekiket, esőkabátokat stb.. A szárítás előtt fordítsa ki őket.	2	1000	135

Vegyes(Napi)	Ezzel a programmal pamut és szintetikus ruhát is száríthat.Ezzel a programmal a sport- és fitness ruhákat száríthat.	4	1000	125
Finom textíliák / Ing	Ez sokkal érzékenyebben szárítja, és kevésbé gyűri meg az ingeket, így megkönnyíti a vasalást.	1,5	1200	60
Higiéna (BabyProtect+)	Ez egy hosszú távú program, amely a higiéniai igénylő ruhákhoz (bébi ruhák, törülközők, fehérneműk, stb.) használatos, ahol magasabb higiénia van szükség. A higiénia magas hőmérséklettel éri el ((Ezt a programot az angol "The British Foundation" (Allergy UK) azonosítja és hagyja jóvá.))	5	800	185
Ágynemű/Toll	Száríthat tollal vagy szálas anyaggal töltött textíliát, mely a szárító címkén feltüntetett, egyetlen ruhadarabként szárítható. A king size méretű paplant, párnát vagy kabátokat egy darab ruhaként száríthatja. Szárítsa ruháit, például a kabátokat és dzsekiket, kifordítva.	-	800	165
Expressz 30'	Használja ezt a programot 2 ing vasalásra előkészítéséhez.	0,5	1200	30
Energiafogyasztási értékek				
Programok	Kapacitás (kg)	A mosódob forgási sebessége (ford/perc)	Maradék nedvességtartalom kb.	Energiafogyasztási értékek kWh
Pamut Eko*	8	1000	60%	1,97
Pamut, vasalásra kész	8	1000	60%	1,5
Szintetikus, szekrényszárász	4	800	40%	0,75
	A teljes és részleges terhelés mellett használt "Pamut Eko program" egy szabványos szárítási program, a címkén és a lapon szereplő információk alapján ez a program alkalmas a normál nedves pamut ruhanemű szárítására, és ez a leghatékonyabb energiafogyasztási program a pamut ruhaneműk számára.			

* : Energia címke standard program (EN 61121:2012)

A táblázatban megadott összes érték az EN 61121:2012 szabvány szerint került rögzítésre.

Ezek az értékek a ruhanemű típusa, a centrifugálási sebesség, a környezeti viszonyok vagy a feszültségingadozás függvényében eltérhetnek a táblázatban megadott értékektől.



MEGJEGYZÉS

- Ha az érzékeny ruhanemű gyűrdés mentes program véget ér, a ruhaneműt azonnal vegyi ki és akassza fel.
- A szárító berendezés programok optimális teljesítménye érdekében a ruhaneműt a mosógépben a megfelelő programmal kell kimosni és a javasolt centrifugálási sebességen kell centrifugálni.
- A program végén az ingek enyhén nedvesek maradhatnak. Azt ajánljuk, ne hagyja az ingeket a szárítógépben.

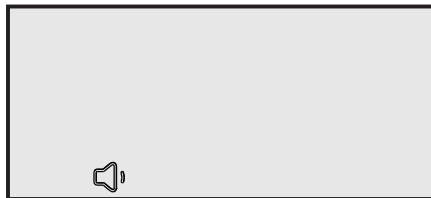

Alacsony hangerő

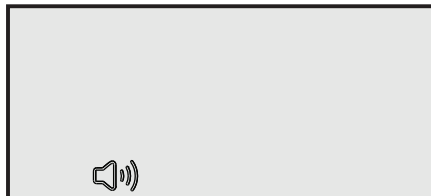

Magas hangerő

Nedvesség szint beállító gomb

☺☺☺ A Nedvesség szint beállító gombot a nedvesség szintjének beállításár használhatja. A program ideje függ a választástól.



MEGJEGYZÉS

- Ezt a funkciót csak a program megkezdése előtt aktiválhatja.

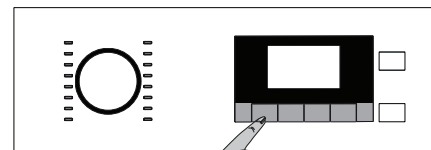

Allergy UK a British Allergy Association márkája. A Jóváhagyó Pecsét azért lett létrehozva, hogy segítse azokat az embereket, akiknek ajánlásra van szükségük a

termékről; tanúsítja, hogy a termék korlátozza/csökkenti/megszünteti az allergének jelenlétét vagy jelentősen csökkenti az allergéntartalmat olyan környezetben, ahol allergiás betegek élnek. Célja, hogy biztosítékot nyújtson arról, hogy termék tudományos teszteken vagy vizsgálatokon esett át mérhető eredmények nyújtása céljából.

5.6 Kiegészítő funkciók

Hangjelzés

☺) A berendezés a program végeztével hangjelzést bocsát ki. A hangjelzés szintjének beállításához használja a Hangfigyelmeztetés szint gombot.



MEGJEGYZÉS

- Beállíthatja a hang szintet a program megkezdése előtt vagy a program folyamán is.

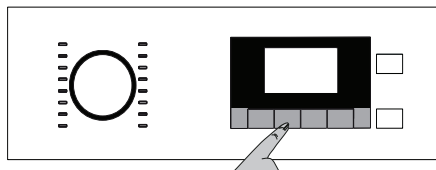



Szárítási szint nedves



Szárítási szint normális



Szárítási szint extra

5.7 Figyelmeztető jelzések



MEGJEGYZÉS

- A figyelmeztető jelzések a berendezés modelltől függően eltérőek lehetnek.

Bolyh-szűrő tisztítása

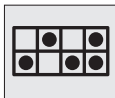

A program végeztével bekapcsol a filter tisztítás figyelmeztető jelzés.



MEGJEGYZÉS

- Részletes információkért lásd 6 Karbantartás és tisztítás.
- Ha a tisztítás jelzés folyamatosan villog, lásd 7 Hibaelhárítás.

A víztartály leeresztése

A program végeztével bekapcsol a víztartály leeresztése figyelmeztető jelzés.



MEGJEGYZÉS

- Részletes információkért lásd 6 Karbantartás és tisztítás.

Ha a víztartály a program közben telik meg, a figyelmeztető jelzés villogni kezd és a gép készenléti üzemmódba vált. Ebben az esetben engedje le a tartályt, majd a program elindításához nyomja meg az Indítás/Bekapcsolva gombot. A figyelmeztető szimbólum eltűnik és a program újra elindul.



A filter fiók tisztítása

A filter fiók tisztítása érdekében a figyelmeztető jelzés folyamatosan villog.



MEGJEGYZÉS

- Részletes információkért lásd 6 Karbantartás és tisztítás.



A betöltő nyílás nyitva

Ha a szárító berendezés betöltő nyílása a szárítás során nyitva van, bekapcsol a Bekapcsolva jelzés és a Program folyamatban jelzés villog.

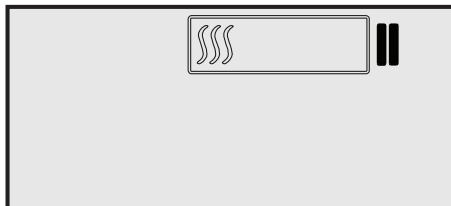

Vége

Az idő vége funkció segítségével a program végének idejét akár 24 órával elhalaszthatja.

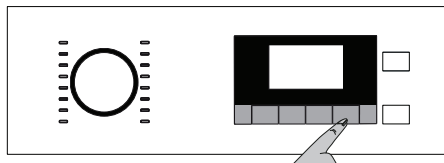

- Nyissa ki a betöltőajtót és helyezze be a ruhaneműt.
- Válassza ki a szárító programot, a centrifuga ciklust és ha szükséges, a további funkciókat.
- Nyomja meg az Idő vége gombot a kívánt késleltetés beállításához. Bekapcsol az idő vége jelzés. (Ha lenyomja és tartja a gombot, az Idő vége non-stop folyamatban lesz).
- Nyomja le a Indítás/Bekapcsolva gombot. Elindul az Idő vége leszámolás és a Start jelzés bekapcsol “:” A kijelzett késleltetett idő közepén található elválasztóvonal villog.

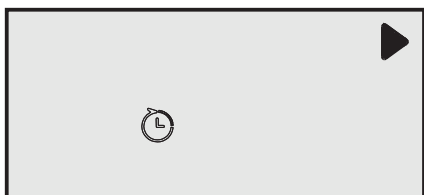

MEGJEGYZÉS

- Az idő lejártá előtt hozzáteheti és kivetheti a ruhaneműt. Az Idő vége jelzés a leszámolás végén kikapcsol, megkezdődik a szárítás és a program időtartá kerül kijelzésre. A kijelzett idő a normál szárítási idő és az Idő vége összege.

Az Idő vége megváltoztatása

Amennyiben a visszaszámlálás alatt szeretné megváltoztatni a késleltetés idejét, akkor:

- A program leállításához nyomja le 3 másodpercig a **Bekapcsol/Kikapcsol/Töröl** gombot. Ismét kapcsolja be a gépet és ismételje meg Késleltetési eljárást a kívánt időtartam erejéig.
- A gép első bekapcsolásakor az alapértelmezett (pamut szárítás) programmal kapcsol be.

Idő vége funkció törlése

Amennyiben törölni szeretné az Idő vége funkciót és azonnal el szeretné indítani a programot:

- A program leállításához nyomja le 3 másodpercig a **Bekapcsol/Kikapcsol/Töröl** gombot.
- Az előzőleg kiválasztott program elindításához nyomja le a **Bekapcsol/Kikapcsol/Töröl** gombot.

5.8 A program indítása

A program elindításához nyomja meg az ▶ Indítás/Bekapcsolva gombot.

A program elindításának jelzéséhez bekapcsol a Start jelzés, a fennmaradó idő közepén található “:” eválasztó villogni kezd. Bekapcsol a Program folyamatban jelzés

5.9 Program folyamatban állapot

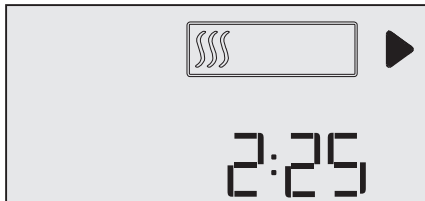

5.10 Gyerekzár

A gépet gyerekzárall rendelkezik annak érdekében, hogy a gombok lenyomásával ne lehessen megváltoztatni az aktuális programot. A gyerekzár aktiválása

- Nyomja le és tartsa 3 másodpercig az Idő programozó és Figyelmeztető hangjelzés gombokat.
- Ha a gyerekzár aktiválva van, a kijelzőn bekapcsol a zár szimbólum.

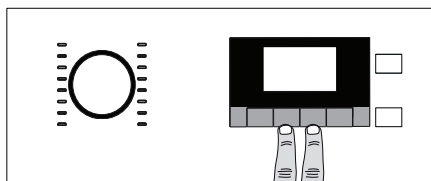



- Ha a gyerekzár aktiválva van, a panelen lévő összes gomb, kivéve a Bekapcsol/Kikapcsol/Töröl és a Gyerekzár gombokat deaktiválódnak.
- Ha a gyerekzár aktiválva van, a Program választó gomb változtatásával a kijelző szimbólumok nem változnak. A Program választás gomb eltekerése és a funkció gombok lenyomása után a képernyőn a "CL" betűk villannak fel.



- A program végeztével új program elindításához, illetve a program megszakításához a gyerekzárát fel kell oldani.

A gyerekzár deaktiválása:

- Egyidejűleg nyomja le és 3 másodpercig tartsa lenyomva a Gyerekzár gombot.
- Ha a gépet újraindítja a **Bekapcsol/Kikapcsol/Töröl** gombbal, a gyerekzár kikapcsol.

5.11 A program módosítása indítás után

A gép elindítása után megváltoztathatja a szárítási programot egy másik programra.

- Például, ha a Vasaló száraz helyett az Extra száraz programot szeretné kiválasztani, a program törléséhez nyomja le az Indítás/Bekapcsolva gombot.
- A Programválasztó tekerőgomb segítségével válassza ki az Extra száraz programot.
- A program elindításához nyomja meg az Indítás/Bekapcsolva gombot.

Ruhanemű hozzáadása és eltávolítása bekapcsolt állapotban

- Ruhanemű hozzáadásához, illetve kivételéhez a szárítási program elindulását követően:
- A gép készenléti üzemmódba állításához nyomja meg az Indítás/Bekapcsolva gombot. A szárítási folyamat leáll.
- Nyissa ki a betöltőajtót Bekapcsolva üzemmódban, adja hozzá vagy vegye ki a ruhákat, majd csukja vissza az ajtót.
- A program elindításához nyomja meg az Indítás/Bekapcsolva gombot.



MEGJEGYZÉS

- A szárítás megkezdése után hozzáadott ruhaneműt azt eredményezheti, hogy a gépben lévő, már megszáradt ruhák összekeverednek a vizes ruhákkal, így a szárítási folyamat végén a ruhanemű nedves marad.
- A ruhanemű hozzáadását és eltávolítását a szárítás ideje alatt akármennyiszor megismételheti. De ezzel többször megszakítja a szárítási folyamatot és növeli a programidőt és az energiafogyasztást is. A ruhanemű hozzáadása ezért a szárítási program elindulása előtt javasolt.
- Ha a berendezés bekapcsolt állapotában a program választó gombbal új programot választ, a folyamatban lévő program megszakad és a képernyőn az új program információi jelennek meg.



FIGYELMEZTETÉS!

- Ha a program futása közben adagol vagy vesz ki ruhát, a dob belső felszínét ne érintse meg. A dob felszíne ugyanis forró.

5.12 Program törlése

Ha bármilyen okból kifolyólag szeretné a szárítást leállítani és a programot törölni azután, hogy a gép elindult, nyomja meg a **Bekapcsol/Kikapcsol/Töröl** gombot 3 másodpercig.



FIGYELMEZTETÉS!

- Ha a programot a berendezés működése közben állítja le, a berendezés belseje forró lehet, tehát kapcsolja be a szellőztetés programot hogy lehűtse.

5.13 Program vége

Ha a program véget ér, a Bolyhszűrő tisztítása és a Víztartály figyelmeztető jelzések kigyulladnak. Az betöltőajtó kinyitható és a gép készen áll a következő szárítási ciklusra. Kapcsolja ki a gépet és nyomja meg a **Bekapcsol/Kikapcsol/Töröl** gombot.

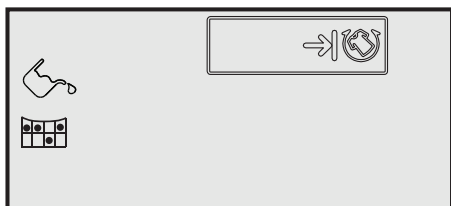

MEGJEGYZÉS

- Ha a ruhaneműt a program végeztével nem távolították el, a Gyűrődés megelőzés funkció bekapcsolja a 2 órás Gyűrődés megelőzés programot.
- Minden szárítás után tisztítsa meg a bolyhszűrőt. Lásd 6.1 Bolyh szűrő tisztítása / Betöltőajtó belső felület
- Minden szárítási ciklus után engedje le a vizet. Lásd 6.3 Víztartály ürítése

5.14 Szag funkció

E funkció használatához olvassa el a ProScent kézikönyvet, ha szárítója rendelkezik szag alkalmazási képességgel.

6 Karbantartás és tisztítás

6.1 Betöltőajtó belső felület

A szárítási folyamat során kiválasztott haját, szűrőket és szöszöket a szöszszűrő gyűjti össze.



MEGJEGYZÉS

- A szöszök a ruhák viselése és mosása során keletkeznek.
- A szűrő nyílását porszívóval tisztíthatja.



FIGYELMEZTETÉS!

- Minden szárítási ciklust követően tisztítsa ki a szöszszűrőt és a betöltő ajtó belső felületét.

A szöszszűrő tisztításához:

- Nyissa ki a betöltőajtót.
- Tartsa a két részes szöszszűrő első részét (a belső szűrőt), és vegye ki felfelé kihúzva azt.
- Kezével vagy puha ronggyal gyűjtse össze a szöszöket, bolyhokat és pamutgombócokat.
- Vegye ki a második részt (a külső szűrőt) felfelé kihúzva azt.

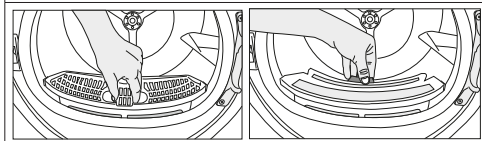

MEGJEGYZÉS

- Ugyeljen, hogy haj, szőrök, szöszök és pamutgombócok ne essenek a nyílásba, ahova a szűrőt kell behelyezni.
- Nyissa ki mindkét szöszszűrőt (a belső és a külső szűrőt), távolítsa el a haját, szöszöt, pamutgombócokat nedves kézzel vagy porszívóval vagy egy ruhával.

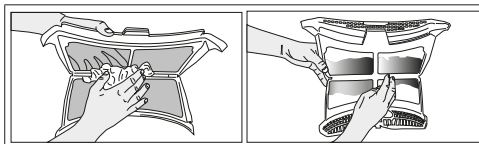

- Tisztítsa meg mindkét szűrőt folyóvíz alatt, a szösz felgyűlésével ellentétes irányban, vagy egy puha kefe használatával. Szárítsa meg a szűrőt, mielőtt visszahelyezné.

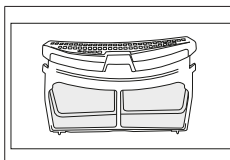
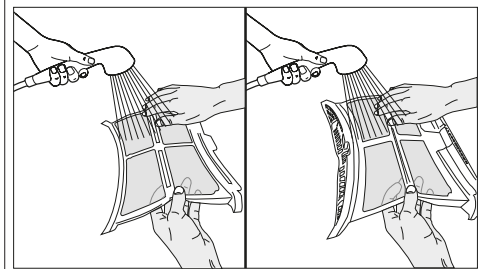

- Helyezze a két szöszszűrőt egymásra, és helyezze vissza azokat a helyükre.

- Tisztítsa meg a betöltő ajtó belsejét és az alátétet nedves puha ruhával.

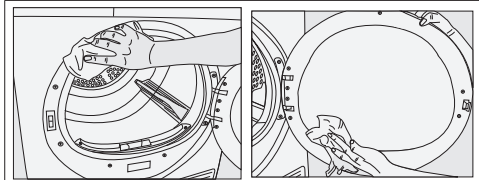

6.2 A szenzor tisztítása

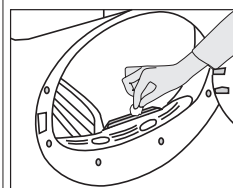

A szárítógépben nedvesség szenzorok találhatók, amelyek érzékelik, hogy a ruha száraz-e vagy sem.
A szenzorok tisztításához:

- Nyissa ki a szárítógép betöltőajtóját.
- Várja meg, amíg a gép lehűl, ha az még meleg a szárítást követően.
- Ecettel megnedvesített puha ruhával törölje át a szenzor fém felületeit, majd szárítsa meg.



MEGJEGYZÉS

- Tisztítsa évente 4 alkalommal a szenzorok fém felületeit.
- A szenzorok fém felületeinek tisztítása során ne használjon fém eszközöket.



FIGYELMEZTETÉS!

- A tisztítás során soha ne használjon oldószereket, tisztítószerkeket és hasonló anyagokat, tűz- és robbanásveszély miatt!

6.3 A víztartály leeresztése

A szárítási folyamat során a ruhákban lévő nedvességet a gép eltávolítja és kondenzálja, a meglévő víz a víztartályban gyűlik össze. Minden szárítási ciklus után engedje le a vizet.



FIGYELMEZTETÉS!

- A kondenzvíz nem iható!
- Program közben soha ne távolítsa el a víztartályt!

Amennyiben a víztartályt elfelejti leereszteni, a gép a következő szárítási ciklusok során, amikor a víztartály teli van, leáll, a Víztartály telítettségét jelző fény pedig villog. Amennyiben ez az eset áll elő, eressze le a víztartályt, majd nyomja meg a Start / Pause gombot, a szárítási ciklus folytatásához.

A víztartály leeresztéséhez:

1. Óvatosan emelje ki a víztartályt a fiókból vagy a tartójából.

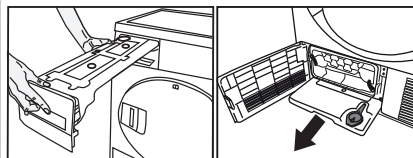

2. Öntse ki a vizet a tartályból.

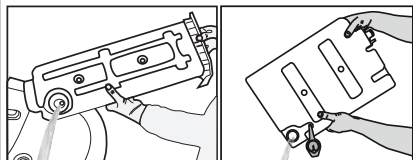

- Amennyiben a víztartály tölcserében szöszök gyűltek fel, folyó víz alatt tisztítsa meg azt.
- Helyezze vissza a víztartályt.



MEGJEGYZÉS

- Amennyiben lehetősége van közvetlen vízleeresztésre, nem szükséges ürítenie a víztartályt.

6.4 A párologtató tisztítása

Azok a szűrők és szöszök, amit a szöszszűrő nem fog fel, a párologtató lamellái közé kerülnek, a biztonsági rács mögött, és ott gyűlnek össze. Tisztítsa ki a párologtatót fél évente, vagy amikor a párologtató "☹️" ikon villogó jelzést ad.

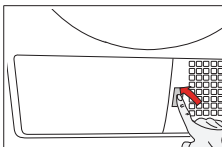

- Nyissa ki a biztonsági rácsot annak megnyomásával.

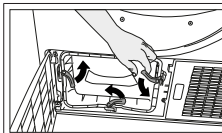

- A légtérelő ajtó megnyitásához mozgassa az oldó reteszt.

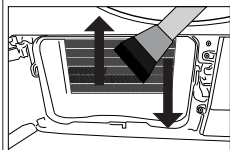

- Távolítsa el a párologtatóról a szőszöket nedves ruhával vagy porszívóval kefések előtét alkalmazásával, a porszívófej fel- és lefelé való mozgatásával.

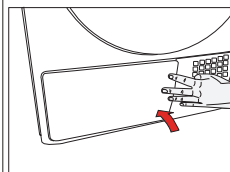

- A tisztítás elvégzését követően helyezze a légterelő ajtaját a helyére, zárja a reteszt, és zárja vissza a biztonsági rácsot.



FIGYELMEZTETÉS!

- A tisztítást kézzel is végezheti, amennyiben védőkesztyűt visel. Ne próbálja meg csupasz kézzel végezni a tisztítást. A párologtató lamellái megsérthetik a kezét.
- A balról jobbra való mozdulattal végzett tisztítás kárt okozhat a párologtató lamelláiban. Ez szárítási problémákat eredményezhet.

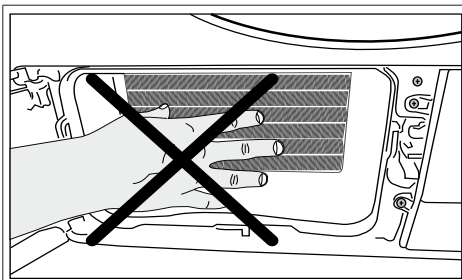

7 Hibaelhárítás

A szárítási művelet túl hosszán tart.

Szösszszűrő (belső és külső szűrő) pórusai eltömődhetnek. >>> Mossa ki a szösszszűrőket meleg vízzel, és szárítsa meg.

A párologtató elülső oldala eltömődhetett. >>> Tisztítsa meg a párologtató elülső oldalát.

A gép elején található szellőzórácok zárva lehetnek.

>>> Távolítsa el minden tárgyat a szellőzórácok elől, ami akadályozhatja a levegő útját.

Lehetséges, hogy a szellőzés nem megfelelő, ugyanis a hely, ahová a gépet beszerelték, túl kicsi. >>> Nyissa ki az ajtót vagy az ablakokat, hogy megakadályozza, hogy a hőmérséklet túl magasra emelkedjen a helyiségben.

A nedvesség-érzékelőn vízkórteleg rakódhatott le. >>>

Tisztítsa meg a nedvesség érzékelőt.

Lehet, hogy túl sok ruhát töltött be. >>> Ne töltse túl a szárítógépet.

Lehet, hogy a ruhák nincsenek megfelelően kicentrifugázva. >>> Kapcsolja nagyobb fordulatszámra a centrifugát a mosógépen.

A ruhák a szárítást követően is nedvesek.

Lehetséges, hogy nem a ruhaj típusnak megfelelő programot használt. >>> Ellenőrizze a ruhák kezelésre vonatkozó címkéit, majd válasszon a ruhaj típusnak megfelelő programot, vagy kiegészítésül használjon más időprogramot.

Szösszszűrő (belső és külső szűrő) pórusai eltömődhetnek. >>> Mossa ki a szűrőket meleg vízzel, és szárítsa meg.

A párologtató elülső oldala eltömődhetett. >>> Tisztítsa meg a párologtató elülső oldalát.

Lehet, hogy túl sok ruhát töltött be. >>> Ne töltse túl a szárítógépet.

Lehet, hogy a ruhák nincsenek megfelelően kicentrifugázva. >>> Kapcsolja nagyobb fordulatszámra a centrifugát a mosógépen.

A szárítógép nem kapcsol be, vagy a program nem indul el. A szárítógép nem működik a konfigurálást követően.

Lehetséges, hogy a kábel ki van húzva. >>> Ellenőrizze, hogy a tápkábel be van-e dugva.

A betöltőajtó félig nyitva van. >>> Győződjön meg róla, hogy a betöltőajtó biztosan be van-e zárva.

A programot nem lehet beállítani, vagy a Start/Szünet/Töröl gombot nem lehet megnyomni. >>> Ellenőrizze, hogy a programot beállította-e, és nem Szünet módban van.

Lehetséges, hogy a gyerekszár aktív. >>> Kapcsolja ki a gyerekszárát.

A program idő előtt ok nélkül megszakadt.

Lehetséges, hogy a betöltőajtó teljesen be van csukva. >>> Győződjön meg róla, hogy a betöltőajtó biztosan be van-e zárva.

Lehetséges, hogy áramkimaradás van. >>> A program elindításához nyomja meg az Indítás/Szünet/Törés gombot.

Lehet, hogy a víztartály megtelt. >>> Eressze le a víztartályt.

A ruhák összemertek, megkeményedtek vagy tönkrementek.

Lehetséges, hogy nem az adott ruháknak megfelelő programot használt. >>> Ellenőrizze a ruhán található címkét, és az anyagnak megfelelő programot válasszon.

A betöltőajtón víz csepeg.

Lehetséges, hogy a betöltőajtó belső oldalán és a betöltőajtó tömítésén szálak gyűltek fel. >>> Tisztítsa meg a betöltőajtó belső felületét és az ajtó tömítéseit.

A betöltőajtó magától kinyílik.

Lehetséges, hogy a betöltőajtó teljesen be van csukva. >>> Tolja be a betöltőajtót, amíg a becsukódást jelző hangot nem hallja.

A Víztartály figyelmeztető jelzés világít/villog.

Lehet, hogy a víztartály megtelt. >>> Eressze le a víztartályt.

Lehetséges, hogy a vízleeresztő tömlő tönkrement. >>> Ha a készülék közvetlenül csatlakozik a vízleeresztőhöz, ellenőrizze a tömlőt.

A szárítógépen belüli világítás nem kapcsol fel. (Lámpával ellátott modellek esetén)

Lehet, hogy a szárítógépet nem csatlakoztatták be a Be/Ki gombbal. >>> Győződjön meg róla, hogy a szárítógépet bekapcsolta.

Lehetséges, hogy a lámpa meghibásodott. >>> A lámpa cseréje érdekében vegye fel a kapcsolatot a Hivatalos Szervizzel.

A gyűrődésmentes ikon világít.

A ruhák gyűrődését megakadályozó gyűrődésmentes üzemmód aktívává lehet. >>> Kapcsolja ki a szárítót és vegye ki a ruhákat.

A szösszszűrő tisztítására figyelmeztető ikon világít.

Szösszszűrő (belső és külső szűrő) szennyezett lehet. >>> Mossa ki a szűrőket meleg vízzel, és szárítsa meg.

A szösszszűrő pórusain lepedék képződhetett, ami eltömődést okoz. >>> Mossa ki a szűrőket meleg vízzel, és szárítsa meg.

Lehet, hogy a szösszszűrők nincsenek behelyezve. >>> Helyezze be a belső és a külső szűrőt a helyére.

Figyelmeztető hangjelzést ad a gép

Lehet, hogy a szösszszűrők nincsenek behelyezve. >>> Helyezze be a belső és a külső szűrőt a helyére.

A párologtató figyelmeztető ikonja villog.

A párologtató elülső oldala szösszel eltömődhetett. >>> Tisztítsa meg a párologtató elülső oldalát.

Lehet, hogy a szösszszűrők nincsenek behelyezve. >>> Helyezze be a belső és a külső szűrőt a helyére.

A szárítógépen belüli világítás felkapcsol. (Lámpával ellátott modellek esetén)

Ha a szárítógép a hálózatra van csatlakoztatva, a Be/Ki kapcsolót megnyomják, és az ajtó nyitva van, akkor a világítás felkapcsolódik. >>> Húzza ki a hálózati csatlakozót, vagy állítsa a Be/Ki kapcsolót "Ki" állásba.



FIGYELMEZTETÉS!

- Amennyiben a probléma a jelen fejezetben közölt útmutatások követése után is fennáll, vegye fel a kapcsolatot eladójával vagy a Hivatalos szervizzel. Soha ne próbálja egyedül megjavítani a készüléket.



MEGJEGYZÉS

- Amennyiben a berendezés bármely alkatrészét illetően problémával találkozik, a hivatalos szerviztől kérheti annak cseréjét, megadva a készülék modellszámát.
- Amennyiben a berendezést nem eredeti alkatrészekkel használja, az hibás működést eredményezhet.
- A gyártót és a forgalmazót semmilyen felelősség nem terheli a nem eredeti alkatrészekkel történő használatból eredő hibákért.

TERMÉKISMERTETŐ ADATLAP

Megfelel a Bizottság 392/2012 sz. (EU) felhatalmazáson alapuló rendeletének

A forgalmazó neve vagy márkája		BEKO
A típus neve		DS8444RX 7188233810
Névleges kapacitás (kg)		8.0
Forgódobos szárítógép típus	Légbefúvásos	-
	Kondenzátor	•
Energiahatékonysági osztály ⁽¹⁾		A++
Éves energiafelhasználás (kWh) ⁽²⁾		234,7
Vezérlés típusa	Automatikus	•
	Nem-automatikus	-
Energiafelhasználás teljes töltetű normál pamutprogram esetén (kWh)		1,97
Energiafelhasználás féltöltetű normál pamutprogram esetén (kWh)		1,08
Energiafogyasztás kikapcsolt üzemmódban teljes töltetű normál pamutprogramhoz, P_o (W)		0,10
Energiafogyasztás kikapcsolt üzemmódban teljes töltetű normál pamutprogramhoz, P_L (W)		1,00
A bekapcsolva hagyott üzemmód időtartama (perc)		30
Normál pamut program ⁽³⁾		
A teljes töltetű normál pamutprogram programideje $T_{szárz}$ (perc)		197
A részleges töltetű normál pamutprogram programideje, $T_{szárz 1/2}$ (perc)		125
A teljes és részleges töltetű normál pamutprogram súlyozott programideje (T_s)		156
Kondenzációhatékonysági osztály ⁽⁴⁾		B
Átlagos kondenzáció hatékonyság standard pamut program esetén, teljes adag, C_{dry}		85%
Átlagos kondenzáció hatékonyság standard pamut program esetén, részleges adag, $C_{dry 1/2}$		85%
A teljes és féltöltetű normál pamutprogram súlyozott kondenzációhatékonysági osztálya, C_t		85%
A teljes töltetű normál pamutprogram hangteljesítményszintje ⁽⁵⁾		65
Beépített		-

• : Igen - : Nem

(1) A+++-tól (leghatékonyabb) D-ig (legkevésbé hatékony) terjedő skála

(2) Az energiafelhasználás 160 teljes és részleges töltetű normál pamutprogram szárítási ciklusán alapul, alacsony energiaszintű teljesítmény fokozaton. Az aktuális energiafelhasználás/ciklus a készülék alkalmazási módjától függ.

(3) "A teljes és a részleges töltet mellett „Szekrényzáraz pamutprogram” az a normál nedves pamut ruhaneműk szárítására alkalmas standard szárítóprogram, amelyre a címken és a termékismertető adatlapon megadott adatok vonatkoznak, és amely a pamut ruhaneműk esetében az energiafogyasztás szempontjából a leghatékonyabb.

(4) G-től (legkevésbé hatékony) A-ig (leghatékonyabb) terjedő skála

(5) Súlyozott átlagos érték — L_{WA} B(A)-ban kifejezve 1 pW-ra vonatkoztatva

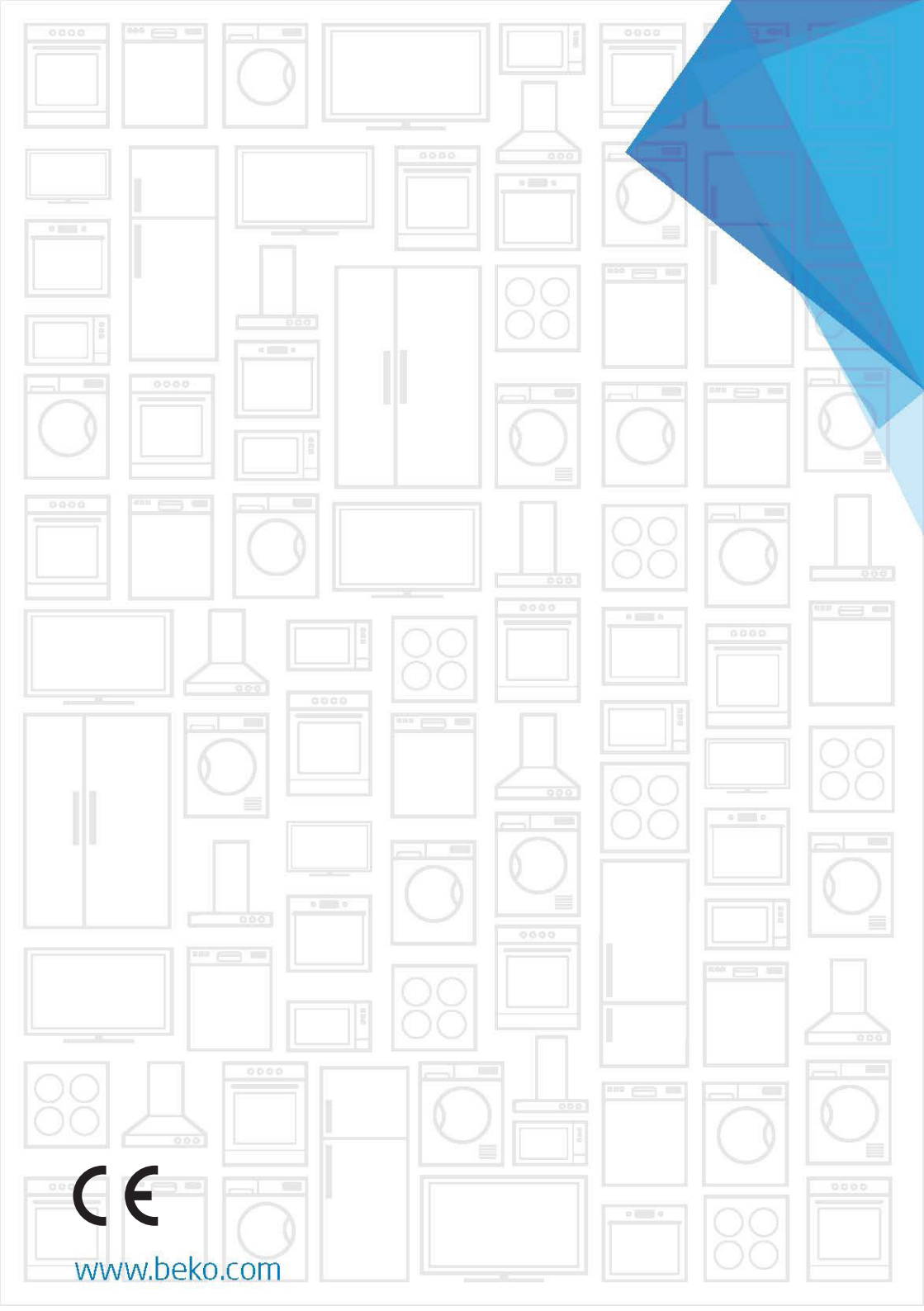

www.beko.com