

DDS 25840 SERIES

8 Place settings
Top control screen



Main Features

- 5 programs
- 3 wash temperatures
- Prosmart Inverter Motor
- Condensing drying system
- 49 dBA wash noise level
- Program follow-up display
- Time delay up to 1-24 hrs.
- Auto tablet detergent function
- 1/2 Load function
- SuperRinse function
- Extra Drying function
- Fast function
- 3 way euro filtering system
- Front adjustable rear feet
- Front adjustable hinge system
- Interior highloop with air gap
- Power plug

Interior Design

- All stainless steel tank
- Three spray arms (lower, upper and ceiling)

Premium Rack Loading System

- Easy Fold loaded adjustable upper rack
- Upper and lower rack handle
- 4 adjustable mug shelves
- Cutlery basket

Color

- DDS25840X: Stainless steel
- DIS25840: Fully Integrated



FEATURES



8 Place Settings

Beko dishwashers can perfectly clean dishes upto 8 place settings without leaving any piece of cutlery out.



Fast Function

The dishwasher increases the washing temperature and adjust the water pressure to provide up to 2 times faster cleaning performance.

Extra Drying

Provides extra 10-18 minutes of intense heating to minimize water stains. This feature provides up to 70% more glossiness on glasses.



SuperRinse

Additional rinsing function for households who desire an extra rinsing cycle with more water.



Auto Tablet

Sensors detects rinse aid and automatically sets drying cycle duration. This provides the best drying results without any concern.



Prosmart Inverter Motor

Variable speed circulation motor allows to use optimum necessary amount of water and energy. Due to magnetic design the motor has no persistent low frequency sound, and creates less vibration.

DDS 25840 SERIES

8 Place settings Top control screen

CONTROLS

Control Type	Electronic
Position	Top

MAIN FEATURES

Loading Capacity (place settings)	8
Tub material	Stainless Steel
Inner door material	Stainless Steel
Water Softener	-
DMFS overflow protection	✓
5 level wash with 3rd spray arm	✓
Delay timer up to 1-24 hrs	✓
3 way euro filter	✓
Drying	Condensation
Turbidity sensor	✓
Silence level, dBA	49 dBA
InnerClean	✓
Auto Tablet function	✓
1/2 Load function	✓
Sanitize function	-
SuperRinse function	✓
Extra Drying	✓
Fast function	✓
Interior high loop with airgap	✓
Power Plug	✓

PROGRAMS

Number of programs	5
Heavy plus (167°F rinse temp)	✓
Normal (142°F-145°F rinse temp)	✓
Clean&Shine	✓
Delicate (149°F rinse temp)	-
Express (131°F rinse temp)	✓
Rinse & Hold	✓

DISPLAY

Program sequence	✓ / Screen
Rinse aid indicator	Electronic
Rinse aid indicator display	✓
Salt indicator display	-
Light Indicator on Floor	-

RACK SYSTEM

Easy fold lower rack folding tines	✓
Lower rack embossed stainless handle	-
Cutlery basket	Standard
Upper rack (inset shelves)	4
Easy fold upper rack folding tines	✓
Acrobat System, adjustable upper rack	Loaded
Nylon coated racks	✓

DIMENSIONS

Packed (HxWxD)	in	34 3/8x19 3/16x26
	cm	85.9x49.4x66.1
Packed Weight	(lb/kg)	81/37
Unpacked (HxWxD)	in	32 1/4x17 3/4x22 2/5
	cm	81.8x44.8x57
Unpacked Weight	(lb/kg)	75/34

ENVIRONMENTAL STANDARDS

Energy Star qualified	✓
Energy consumption, kWh/year	220
Water consumption, gal/cycle	2,54 - 4,07
RoHS* compliant	✓

* Lead-free

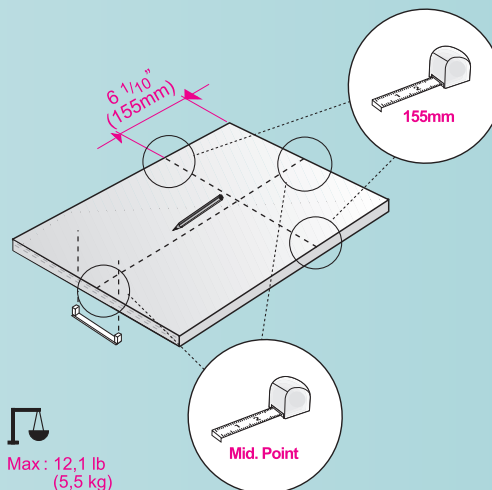
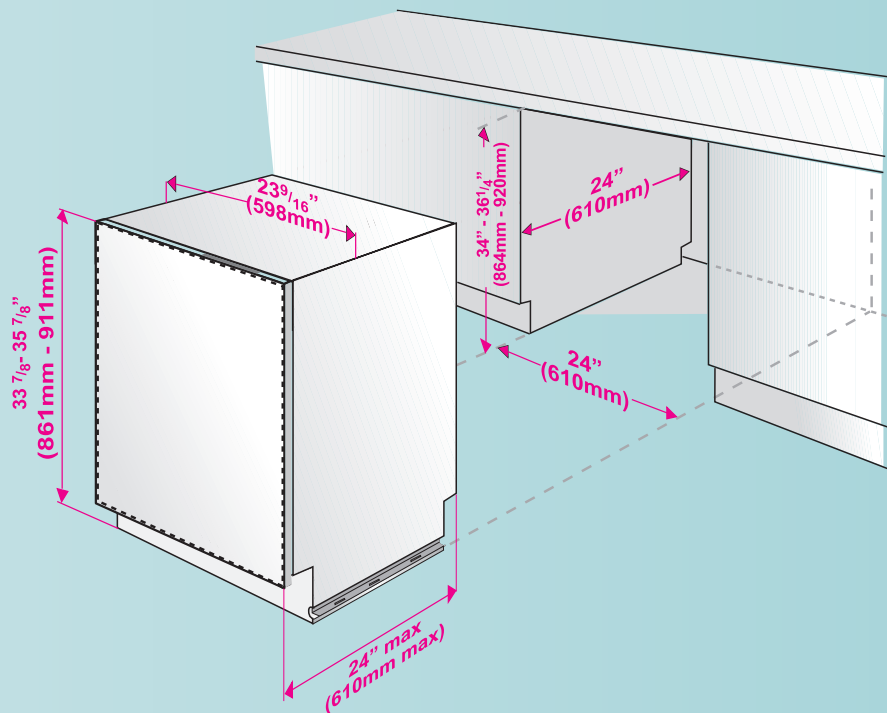

beko